



GROUSE SHOOTING

①
SHOOTING

BY

LORD WALSLINGHAM

AND

SIR RALPH PAYNE-GALLWEY, Bt.

Author of 'Book of Duck Decoys' & 'The Fowler in Ireland'

WITH CONTRIBUTIONS BY

LORD LOVAT AND LORD CHARLES LENNOX KERR

MOOR AND MARSH



WITH NUMEROUS ILLUSTRATIONS BY

A. F. STUART-WORTLEY, HARPER PENNINGTON C. WHYMPER

J. G. MILLAIS AND G. E. LODGE

Second Edition

LONDON

LONGMANS, GREEN, AND CO

1887

DEDICATION

TO

H.R.H. THE PRINCE OF WALES.



BADMINTON: *October 1885.*

HAVING received permission to dedicate these volumes, the BADMINTON LIBRARY of SPORTS and PASTIMES, to HIS ROYAL HIGHNESS THE PRINCE OF WALES, I do so feeling that I am dedicating them to one of the best and keenest sportsmen of our time. I can say, from personal observation, that there is no man who can extricate himself from a bustling and pushing crowd of horsemen, when a fox breaks covert, more dexterously and quickly than His Royal Highness; and that when hounds run hard over a big country, no man can take a line of his own and live with them better. Also, when the wind has been blowing hard, often have I seen His Royal Highness knocking over driven grouse and

partridges and high-rocketing pheasants in first-rate workmanlike-style. He is held to be a good yachtsman, and as Commodore of the Royal Yacht Squadron is looked up to by those who love that pleasant and exhilarating pastime. His encouragement of racing is well known, and his attendance at the University, Public School, and other important Matches testifies to his being, like most English gentlemen, fond of all manly sports. I consider it a great privilege to be allowed to dedicate these volumes to so eminent a sportsman as His Royal Highness the Prince of Wales, and I do so with sincere feelings of respect and esteem and loyal devotion.

BEAUFORT.

PREFACE.

A FEW LINES only are necessary to explain the object with which these volumes are put forth. There is no modern encyclopædia to which the inexperienced man, who seeks guidance in the practice of the various British Sports and Pastimes, can turn for information. Some books there are on Hunting, some on Racing, some on Lawn Tennis, some on Fishing, and so on; but one Library, or succession of volumes, which treats of the Sports and Pastimes indulged in by Englishmen—and women—is wanting. The Badminton Library is offered to supply the want. Of the imperfections which must be found in the execution of such a design we are conscious. Experts often differ. But this we may say, that those who are seeking for knowledge on any of the subjects dealt with will find the result of many years' experience written by men who are in every case adepts at the Sport or Pastime of which they write. It is to

point the way to success to those who are ignorant of the sciences they aspire to master, and who have no friend to help or coach them, that these volumes are written.

To those who have worked hard to place simply and clearly before the reader that which he will find within, the best thanks of the Editor are due. That it has been no slight labour to supervise all that has been written he must acknowledge ; but it has been a labour of love, and very much lightened by the courtesy of the Publisher, by the unflinching, indefatigable assistance of the Sub-Editor, and by the intelligent and able arrangement of each subject by the various writers, who are so thoroughly masters of the subjects of which they treat. The reward we all hope to reap is that our work may prove useful to this and future generations.

THE EDITOR.

CONTENTS.

CHAPTER	PAGE
I. GROUSE	I
II. BLACK GAME	45
III. DEER STALKING	57
IV. DEER FORESTS	101
V. WOODCOCK	112
VI. SNIPE	134
VII. WILDFOWL SHOOTING—SWANS AND GEESE	150
VIII. SURFACE-FEEDING DUCKS	169
IX. DIVING DUCKS	185
X. WADERS	202
XI. RAILS AND CRAKES	219
XII. WILDFOWL SHOOTING ON SHORE	225
XIII. PUNTING, OR WILDFOWL SHOOTING AFLOAT	240
XIV. FOWLING PUNTS: HOW TO BUILD AND USE THEM	263
XV. SWIVEL-GUNS	274
XVI. CONCLUDING REMARKS ON WILDFOWL SHOOTING	303
XVII. A LITTLE PLAIN LAW FOR GAME PRESERVERS, KEEPERS AND POACHERS	316
INDEX	337

ILLUSTRATIONS.

ENGRAVED BY E. WHYMPER, J. D. COOPER, G. PEARSON,
G. E. LODGE, R. B. LODGE, G. FORD.

FULL-PAGE ILLUSTRATIONS.

	ARTIST	
✓ GROUSE SHOOTING	{ <i>A. J. Stuart-Wortley</i> } { <i>Harper Pennington</i> }	<i>Fron.</i>
✓ A WALK ON HIGH GROUND	{ <i>A. J. Stuart-Wortley</i> } { <i>Harper Pennington</i> }	<i>to face p.</i> 8
✓ GROUSE DRIVING	{ <i>A. J. Stuart-Wortley</i> } { <i>Harper Pennington</i> }	" 24
✓ STALKING GROUSE ON THE STOOKS	{ <i>A. J. Stuart-Wortley</i> } { <i>Harper Pennington</i> }	" 40
✓ 'BLACKCOCK OVER'	{ <i>A. J. Stuart-Wortley</i> } { <i>Harper Pennington</i> }	" 49
✓ AN INTERLOPER	{ <i>A. J. Stuart-Wortley</i> } { <i>Harper Pennington</i> }	" 100
✓ 'HERE THEY COME'	<i>C. Whympere</i>	" 170
✓ WILDFOWL AT SEA	<i>J. G. Millais</i>	" 244

WOODCUTS IN TEXT.

	ARTIST	PAGE
A POINT	{ <i>A. J. Stuart-Wortley</i> } { <i>Harper Pennington</i> }	I
GEORGE SYKES		13
A BATTERY	<i>G. E. Lodge</i>	17

CHAPTER I.

GROUSE.



NVIGORATING mountain air and wild scenery impart a special charm to grouse shooting. To see good dogs working over a wide range of heather, carefully quartering the likely ground and backing each other with stiffened limbs and tails at each steady point, is delightful to a sportsman, the more so as the use of dogs in the pursuit of partridges is growing more and more rare.

Good lungs, good muscle, good nerve, and good sight are all more or less essential to any large measure of success.

A wholesome rivalry, if not allowed to degenerate into jealousy, enhances the enjoyment of healthy exertion and gives zest to the pursuit. How many men of all ages can recall with intense delight the particular triumphs of red-letter days in their sporting calendar! Who will deny that a proper combination of 'weather, heather, feather' constitutes one of the keenest of life's many joys?

Here, as in the case of partridges, some 'old school' sportsman may be disposed to break out into abuse of driving. But if an excuse is wanted for this practice, which those who are well acquainted with it will by no means admit, not only an excuse but a thorough justification is to be found in the great change that has taken place of late years in the habits at least of English grouse. Whereas, well within the memory of many of the present generation of keepers, it was practicable to obtain good sport with pointers on the Yorkshire moors until late in the month of October, there would certainly now be but a very poor chance of making a decent bag in this manner—especially after the end of August. On some ground the birds are already assembled in large packs on the tops of the hills by the 20th of that month, and the records of good bags recently made over dogs are entirely confined to Scotland, where, especially in the northern parts, grouse still retain the more sedentary habits which tradition attributes to their brethren of the south.

The 'old school' sportsman would perhaps reply that this change of habit is undoubtedly owing to the modern system of pursuit. But all the evidence obtainable from trustworthy sources is opposed to this theory, and points to such a change having been distinctly observed before the institution of the new method. It is more probable that the gradual alteration in climatic conditions, which has put a stop to the cultivation of cereal crops on land bordering the high moors of Yorkshire, has also affected the habits of the moor game. The

contrast between the grouse of England and those of the extreme north, and especially of the western islands of Scotland, is certainly very remarkable. In the Island of Harris, for instance, they may be frequently seen strutting and running before the dogs within a few yards of the shooter, declining to rise from the ground until closely pressed. Here their manner is similar to that of the too confidential ptarmigan in high and seldom disturbed deer forests ; whereas, towards the southern extremity of the natural range of this exclusively British bird, the first appearance of a sportsman is the signal for immediate flight.

It has been stated in a sporting newspaper that grouse feed only once a day, and invariably in the evening, and this statement is founded upon the fact that in the morning their crops are always found empty. It is at least doubtful whether this fact goes so far as to prove the case. The crops of wood pigeons are also found empty in the morning, yet these birds arrive on their feeding ground at an early hour, and proceed immediately to pick up acorns, beech-mast, or other food. Grouse may certainly be seen feeding on stubbles in the early morning, and, as admitted in the journal referred to, they are observed to frequent the young heather in the early part of the day. This is surely for the sake of food. The point can be easily decided by anyone who may entertain serious doubts on the subject if he will take the trouble to watch them with a good glass.

Grouse prefer the tender shoots of young heather to any other kind of food. It is important to secure to them a sufficient supply, and this can best be done by burning every year in the month of March, if weather permits, a certain proportion of the old and slow-growing heather all over the moor. It should not be burnt off in large tracts, but in patches not exceeding half an acre each, so as to provide good feeding ground intermixed with strong holding cover. In the second year after such burning the ground will be fairly covered with young growing heather, which will provide the best kind of

food, and where this is done birds from other moors, where burning is neglected, will probably be attracted in considerable numbers.

It is frequently the case that in the month of March the weather is too wet to admit of much burning, but advantage should be taken of a favourable season, and a strong force of men should be employed to make the most of the time. The fire must not be allowed to run too far, but should be followed and beaten out with sticks or spades when a sufficient patch has been cleared.

The burning of heather is also favourable for increasing pasturage for sheep wherever rough grasses are to be found, and for this reason tenants, shepherds, or those who have a right of pasturage on the moor will be willing to lend help for this purpose. A reasonably limited number of sheep do not seriously interfere with the stock of grouse, provided always that the dogs which attend them are kept under absolute control during the breeding season. Where a good understanding exists between the proprietor of shooting and those who exercise rights of pasturage, no difficulty will be experienced in making such arrangements as will duly protect the breeding birds without causing appreciable inconvenience to the sheep-owners.

On some moors, where poaching by nets is practised, it is the custom to place at intervals strong stakes armed with nails to catch the nets if dragged over the ground, but as there are well-known ways among poachers of getting over this difficulty, it will not be found of much practical use. Good keepers will discover better means of preserving the ground.

It is well known that grouse sometimes die in very large numbers from what has been termed the 'grouse epidemic.' They are subject also in some places to the attacks of tapeworm. Unless it be that the victims of one disease become specially liable to contract the other, there is no evidence that the two are in any way connected either in the causes of their origin or in the progress of their deadly effects.

Authorities differ much as to what may be considered the primary cause of the more serious of these diseases. It has been proved that in birds that die of it large numbers of a small entozoic parasite are to be found. These have been described by an eminent authority, Dr. T. Spencer Cobbold,¹ under the name of *Strongylus pergracilis*, but whether these parasites constitute in themselves the epidemic called 'grouse disease,' or whether the unhealthy condition of the birds from other circumstances renders them peculiarly liable to the attacks of this minute parasite, Dr. Cobbold's determination of the ultimate cause of death does not conclusively establish. As in the case of the 'gapes' produced by another parasite in partridges and pheasants, the strong and healthy birds apparently enjoy no immunity from attack even though food is plentiful, it is quite conceivable that the parasite of the grouse may also attack those which are free from other signs of weakness. In short, the severity of its ravages in certain seasons may be due to atmospheric or other conditions favourable to its existence, and not necessarily connected with the sanitary economy of the birds themselves. At the same time it must be admitted that there is great probability that the epidemic may be rightly attributed to unwholesome food, or to some equally potent cause for the prevalence of weakly condition among its victims. It has been noticed that the serious outbreaks of 1855-56, 1866-67, and 1872-73, were all more or less accompanied by an unhealthy state of the heather.² Wet and cold in winter continued late into the spring had, especially in 1872-73, a most injurious effect upon this favourite food-plant; and if their food had become unwholesome or unpalatable, this in itself would probably be sufficient to account for the unhealthy condition of the birds.

¹ *The Grouse Disease*, T. Spencer Cobbold, M.D., F.R.S., &c., *The Field office*, 1873.

² Many ponies on the moors in Breconshire, South Wales, having died in 1872-73, the intestines of some of them were sent up to London to be analysed, and in all of them thousands of parasites were discovered similar to those found in the intestines of the grouse which had died on the same mountains.—ED.

During the severe or, rather, long-continued frost in the late winter of 1885-86, many moors were almost entirely cleared of grouse. Where the surface of the snow has thawed, and then become frozen, the poor birds have been quite unable to reach the heather, and have been widely scattered over the cultivated lowlands in search of food. At the time of writing it remains to be proved how many of them will find their way back ; but on some moors at least there must necessarily be a serious loss.

Grouse are always in some danger when they venture upon arable land.

When harvest is unusually late or prolonged, how many thousands are annually killed by the agricultural gunner, who, finding them attracted by his stooks of oats, slips along behind the wall in the early morning to get a pot shot? He seldom takes them flying. It pays better to have a go at the 'brown,' where a stook is well crowned with greedy feeders.

It is a favourite poaching trick to cultivate small patches of land in moorland districts for the purpose of attracting grouse and black game. Oatsheafs are purposely left standing in the field, and several birds are frequently killed at a single shot by the successful pot-hunter.

Mr. Carnegie, in his 'Practical Game Preserving,' 'unhesitatingly' agrees with Mr. Harvie Brown in attributing the disease to 'over-preservation,' and adds the words (p. 123):— Over-preservation includes over-stocking and bad food. We fail to see why this should be the case ; on the contrary, if the proper requirements of high preservation are complied with, it should include neither one nor the other. The object of high preservation is undoubtedly to increase the numbers available for sport in each shooting season, but it is, of course, essential that by a correspondingly increased amount of shooting their ranks should be sufficiently thinned to avoid leaving upon the ground a larger quantity of birds than is proportionate to the supply of healthy food produced. By due attention to the burning of old and woody heather, the supply

of young succulent shoots can be maintained and increased, and this in itself will justify the saving of a larger stock of breeding birds than could be kept up if moors were left in their natural condition. If disease has at any time occurred through over-preservation, and the writer is not prepared to dispute it, it must have been through the neglect of one or both these essential elements of success, and it should by no means follow, where such matters receive attention, that the 'rage for big bags' must necessarily be the cause of 'overstocking,' although in the past it may in some cases have been so. Since the great outbreaks of disease have undoubtedly occurred immediately after the best shooting seasons, there is strong presumptive evidence that an abnormal increase in their numbers does in some way render grouse more liable to it ; but their comparative immunity from serious attack on well-stocked moors after 1873 points to the conclusion that the corresponding and necessary remedies have since that time been more generally and faithfully applied.

There is little or nothing new to be written about shooting grouse over dogs. Full instructions are to be found in Thornhill's 'Shooting Directory ;' 'Recreations in Shooting,' by Craven ; 'The Oakleigh Shooting Code ;' 'Sport in the Highlands and Lowlands of Scotland,' by T. Speedy, and many other sporting books and papers. As in partridge shooting, it is, of course, important to give the dogs the wind, and to endeavour as far as possible to concentrate the birds during the early hours of the day upon a sufficient expanse of good high holding-cover, where they can be followed up with advantage. There should be no noise—'silence is golden' when shooting to dogs.

The birds should always be approached from the side or in front, rather than behind the dogs when these are pointing, unless it is especially desired to drive them in a forward direction. Although the very early morning is not the time for killing grouse over dogs, on account of the difficulty of approaching them on their feeding-grounds among young and

therefore short heather, the man who will take the trouble to move them at that time of day will be able to get many shots at them after their first flight. In the evening also they will be found among short heather, rather than in cover where they will lie close ; but at that time of the day they are usually less wild and the scent is often better. Hot sunny weather generally prevents birds from getting up wild. In dull windy weather they seem to be more upon the alert, and it is more difficult to make a good bag. Wet weather is always bad for 'dogging.' On moors where there is plenty of water for the dogs, there is no great difficulty in working during the heat of the day ; but on very dry ground it is necessary to carry water that they may drink occasionally. If it is desired to make a large bag, it is well to have plenty of dogs and to work them in relays so as to keep them fresh and strong throughout the day. So long as your own lungs and legs are good enough to do justice to their work, two or even three couples of fresh pointers or setters may be allowed to run at the same time under the control of an equal number of keepers, walking at a sufficient distance from each other to prevent one couple from interfering with the working of another. By constantly moving from point to point as each dog may indicate the presence of birds, more shots will be obtained than by using one couple only, but it is of course essential that the dogs should be well broken and very steady at the point. Of course for ordinary shooting no one would think of using more than one or two dogs at the same time.

What can be more delightful than a good walk over wild ground with one steady dog sent forward as a skirmisher, a man carrying a few spare cartridges to support the advance and mark the birds, and a boy with a pony and saddle-bags to form the reserve forces? How keenly a good sportsman enjoys the glorious uncertainty of not knowing from shot to shot what may get up next ! The little snipe-marshes, the rush-grown pools, the patches of low birch scrub and bracken along the burn sides, are all visited in turn. A few snipe, a couple of mallards or teal, an occasional woodcock, with a few head of

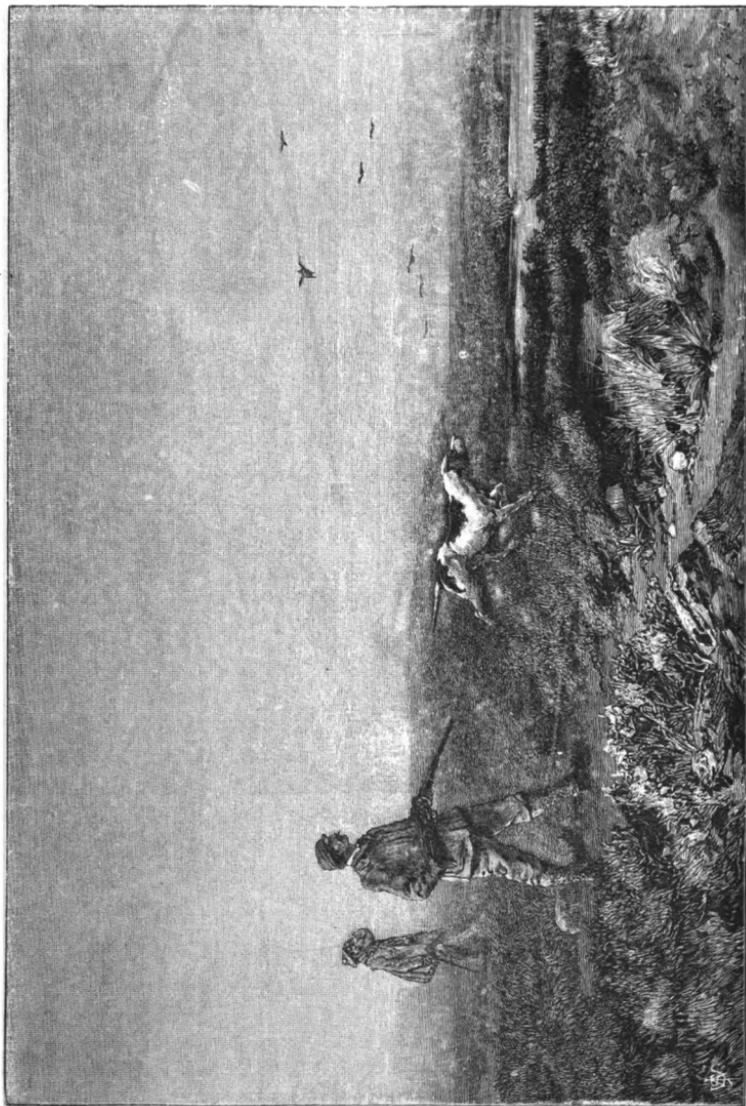

A WALK ON THE HIGH GROUND

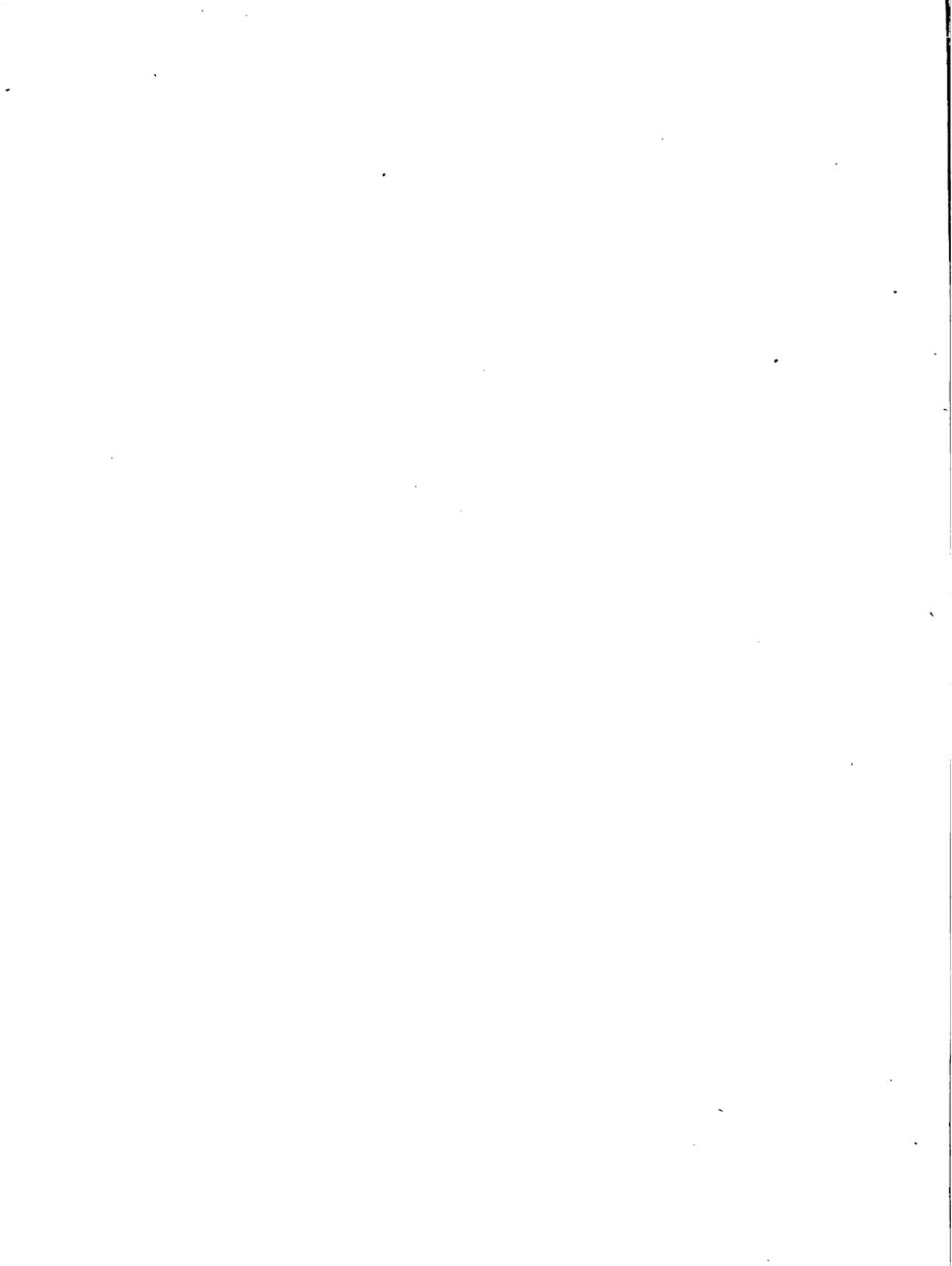

grouse and black game, make up a mixed bag of which anyone has a right to be proud. And if after the day's work, in recalling his little triumphs of skill and judgment, or the merits of his four-legged companion, he has not too many regrets that either he or his gun were not exactly in the right place at the right moment, the curls of smoke from his evening pipe will travel heavenwards with no less serenity than his own peaceful reflections.

Pointers, especially at the beginning of the season, will frequently be crippled by sore feet, owing to the constant friction caused by the rough stems of the heather; setters are, perhaps, less liable to be afflicted in this way. It will be found a good plan after the day's work to soak the dogs' feet in strong brine, which has the effect of hardening the skin. If a marker is employed, and he may be found most useful, especially on uneven ground, he should be placed on some eminence from which he can command a view not only of the shooter and his dogs, but of the direction to which the birds incline their flight. He should be able to see the surface of any good holding-cover which may be protected by a ridge or sky-line from the view of the shooter, but should be so placed as not to turn birds off the beat.

In hot weather the best and most likely ground on which to find the broods of young grouse is about the sloping sides of burns and in beds of mixed bracken and heather. The older birds frequently resort to the neighbourhood of rushes and rough grass, on the seeds of which they delight to feed, and it is not unusual towards evening, as well as in early morning, to find many birds upon damp rushy meadows on the outskirts of the moorland, where they have evidently assembled for the purpose of feeding. In such situations they will not lie well to dogs.

If ground is well and judiciously worked during the first half of the day, so as to ensure that the same birds are flushed several times, good sport may be confidently expected in the afternoon. The broods become scattered, and the single birds

lie closer than if they remain within sight of each other. When they are thus thoroughly scattered, great care should be taken to work the ground closely. If the shooter walks too quickly, or allows his dogs to range too widely, he will inevitably over-run his birds and may waste much time in traversing fresh ground. In shooting with two guns, the loader should follow close behind, and be ready to change quickly the loaded for the empty gun, as it will frequently happen that some stragglers from a brood will rise only when a shot is fired, and there should be time to catch these within range with the second gun.

It has already been stated that working with dogs is a very unremunerative system on most of the English moors. In very favourable weather or extremely early in the season, fair bags may sometimes be made in this way, and no one certainly would decry or dispute the enjoyment of it, if only as affording a healthy exercise. But in Scotland on the contrary, and more especially in the northern counties, a single sportsman on well-stocked ground finds no difficulty in killing from 40 to 70 brace to his own gun, in a fair day's work, and this may be done, according to the writer's experience, even in the month of October. It is indeed extremely doubtful whether, in places where grouse are accustomed to lie close and to take short flights, the practice of driving can be introduced with success. A prejudice certainly exists against it among many Scotch keepers and gillies, and the attempts that have been made in Aberdeenshire and elsewhere have been attended with such moderate results as perhaps to justify a complete adherence to the older system. At the same time it must be admitted that in most parts of Scotland the essential principles of driving are but little understood, but the time may yet come when its advantages will be recognised.

It is difficult to obtain any precise information as to the exact date at which the present system of grouse driving was instituted. The following interesting letter, addressed to William Lipscomb, Esq., of Beech Lawn, near Wakefield (published by

kind permission), gives probably the best account now attainable of the origin of the practice.

Cannon Hall, Barnsley : Nov. 28, 1885.

MY DEAR LIPSCOMB.—. . . As to grouse driving, it was first commenced here by my grandfather's keeper, George Fisher, who told me he used to drive the low moor at Rayner Stones for my uncles when they were boys whenever they shot at Boadhill; they used to lie behind the rocks there. That is all cultivated now, part of Lord Houghton's farm at Bullhouse and of the Sheffield Hospital farm at Flouch—this would be about the year 1805.

I began to shoot grouse in 1841; we had our regular drives then, but without butts. The present Lord Leicester used to come for the twelfth nearly every year, and used to insist on having a few drives.

Three brace for a gun for a drive was considered a large bag, and I remember the first time a bag of 50 brace was got, which would be about 1843, it was considered a great day. Captain Martin, R.N., brother of W. Martin, of Worsborough, was one of the guns. The papers used to contain references of the following kind:

'We are sorry to learn that the unsportsmanlike practice of driving grouse is still continued on Mr. Stanhope's moors: this mode of shooting cannot be too severely reprov'd, &c., &c.'

As you say, when noble lords were asked to drives at Ryshworth and Edwardes' Moor, it suddenly became the right thing and highly popular. As to the butts, on my moors our best drive used to be Snailsden Road, and there was a sandhole there for repairing the road; my father and old George Whitfield used to occupy this sandhole, and we found that that spot always had the best chances, so we thought we would make a few more sandholes. By about 1847 we had a good many holes for guns in different parts of the moor which by degrees were re-arranged and the drives made more extensive. The first drive I can recollect being present at was in 1836, when the late Lord Leicester was at the Boadhill drive, then aged eighty-three; and old Sir William Cooke, of Wheatley, was there with a flint gun, and he brought down an old cock that had come down the length of the line and been shot at by everybody; he took off his white hat and called out: 'There's your copper caps, gentlemen!' I have no old game-book, but I dare say, when I have more time, could get information of

particular days from my father's journal ; the only note I see of my own is that in August, 1849, we got 448 grouse, which, I suppose, was the highest score in August up to that date.

Yours very truly,

W. SPENCER STANHOPE.

The late Mr. Henry Savile's keeper, George Sykes, at Ryshworth Lodge, has generally been credited with the first application of the system of grouse driving ; although he was not entitled to this distinction, he undoubtedly did more than anyone else to extend and improve the practice. He laid out the ground for driving, and arranged the batteries at High Force, at Longshaw, and at other places, and gave instructions to the keepers there which were afterwards followed out with such remarkable effect. It is curious that he should have been found dead in one of the batteries of his own construction.

It is not improbable that the same idea may have occurred to others independently, at or soon after that time. The immediate effect appears to have been to cause a very large increase in the numbers of birds bred upon many of the best moors, while it also enabled the proprietors of shootings to bring to book far better returns than had ever before been realised upon the same space of ground. On the moors of Mr. Rimington-Wilson at Bromhead ; of Lord Ripon at Studley Royal ; of the Duke of Cleveland at Raby ; of Mr. Bowes at High Force and Wemmergill, during the tenancy of General Hall and afterwards of the Duke of Beaufort on the one, and of Sir Frederick Milbank on the other ; of the Duke of Rutland at Longshaw, and the Duke of Devonshire at Bolton, as well as on many other estates, enormous bags have of late years been made, and a vast stock of birds has been kept up to an extent which would have been wholly impossible under the old system. The reason of this great increase, dating from the commencement of driving, is to be found in the pugnacious habits of the, older birds. One pair of old grouse, as is the case with partridges, will take exclusive possession of a much

larger area of ground than will a pair of younger birds. From such selected territory they will at the breeding season mercilessly drive every intruder, and when a moor is not sufficiently shot over, or when too many birds are allowed year after year to escape, the ground is occupied by older birds, and therefore by a much smaller number of pairs than if the stock were properly thinned; the necessary result is that the broods are compara-



Portrait of G. Sykes.

tively few and far between, and the sport to be obtained on a given acreage is proportionately poor. It is not only in the actual thinning of the birds that the effect of driving is favourable to a moor. In walking, with or without dogs, the first to rise when alarmed, and therefore those which most generally escape the shot by keeping at a distance, are the older and more knowing birds; the young are, therefore, the more liable to fall to the gun. It follows that the very birds which are less

adapted to contribute to the next year's sport are in each successive season the more likely to be left on the moor, and to drive from it the younger and probably more prolific birds. But in driving, the birds which rise first and at the greatest distance from the men are the first to come to the gun, and those which assemble in large packs, unapproachable by pointers or setters, have no better chance of escape than others weaker or less wild.

Grouse possess naturally much greater powers of flight than partridges. So soon as they have acquired mature plumage they are capable of continuing on the wing for a much longer time, and as their flight is also more rapid they can traverse considerable distances without alighting. They possess in a great degree the same 'homing' instincts as other game birds, and will soon reassemble on ground from which they have been once disturbed, if the opportunity be allowed to them. It may be doubtful whether this rule applies with equal force on ground which is not thickly stocked. As in the case of partridges, undisturbed birds probably resent the arrival of new-comers and drive them from their vicinity, and opinions differ as to the tendency of Scotch grouse to return to where they have been first found. It may be that on large tracts of equally good feeding or holding ground, as in some parts of Scotland, not thickly occupied, grouse may rest unharassed over a wider range and be less inclined to re-seek their old quarters, but on the English moors they undoubtedly return within a limited time.

From the facility with which grouse can make a wide circuit, and so outflank the longest line of drivers, they are less apt to lie close or to turn back over the beaters' heads than partridges. Long drives are therefore more productive than short ones, as enabling a greater number of birds to be collected over a larger area without the risk of leaving many behind. A mile, or even two miles, is not too great a distance to bring birds successfully to the guns. Begin always if possible at the up-wind end of your beat and drive the birds down

or at right angles to the wind, until you can mass together a sufficient number to make a telling and effective return drive. Then, by working the same ground again, you will be more likely to secure a fair proportion of the stock than if too much fresh ground is taken up. Here, as in partridge driving, no system is more killing than alternate drives backwards and forwards from opposite directions, employing two sets of men to economise time and to prevent the broken packs from re-assembling. As there are no hedgerows, and unless there be walls, as in parts of Derbyshire, it is necessary to construct some kind of shield or shelter to hide the shooters. These are usually formed of blocks of peat or turf, cut with a spade and built up in the form of a wall, circular, horse-shoe, or semicircular in shape.

If these shelters are so placed as to be required only for drives from one direction, a semicircle, or still better a horse-shoe, as affording more concealment at the sides, will be all that is required. But if it be intended to drive in both directions over the same range of batteries, they should be made in a circular form with a small entrance at one side.

To secure the greatest possible amount of cover one end of the wall may be made to overlap the other. It is often useful that shelter should be provided in this way at the sides as well as in front, to prevent birds which approach in a lateral direction from seeing their danger in time to avoid it.

Such batteries when once made require but little repair before each successive shooting season, and by being left standing render the birds familiar with their appearance, and therefore less likely to avoid them in their flight than if they were freshly constructed.

It is essential that each battery should be sufficiently spacious to contain three men and a dog. Except for the too common accompaniment of a persistent cloud of midges, they may even be rendered extremely comfortable by a little attention to details. A pile of dry turf makes an excellent seat; a strong post stuck in the ground enables you to tie your retriever by the

collar, that he may not rush out before the drive is over; a small trench cut round the outside to carry off the surface water will secure a dry floor; and some fresh heather laid upon this enables your dog to be comfortable as well as yourself. Add to this a small shelf at one side for cartridges, that they may be always ready to hand, and a piece of board set up in front, inside the wall, to prevent the muzzles of the guns from getting the peat into them if leaning against it, and you have a very complete arrangement for the purpose. The following plans and measurements will give some idea of the proper proportions:—

Full outside measurement 31 feet 6 inches, across opening 6 feet 6 inches. Height of wall inside, 5 feet. Walls, 24 inches thick at bottom, and 18 inches at the top.

On a steep hill-side the construction of a suitable battery is even more simple. By digging out a few cubic feet of earth its occupants can stand below the proper level of the ground, the soil can be banked up at the sides to afford lateral shelter, and the drainage is easily provided for by sloping the floor. This is commonly known in northern parlance as a 'liggin hoile,' and that term has come to be frequently applied also to the more elaborate constructions previously described. A peat-hag, or turf cutting, when providing a sufficiently high wall to shelter a man standing behind it, may if conveniently situated be often used as a station for a gun, and a stone wall is equally suitable for the purpose.

The most important point to consider in mapping out a moor for driving is the position in which the batteries and ranges of batteries should be placed. Their number must, of course, depend upon the scope of ground available for each drive and upon the numerical strength of the party. This will probably be regulated according to the area and productiveness of the moor and the number of days' shooting required, and will be influenced by considerations of domestic space and economy, and other matters. In one way these

things must affect the choice of position. Whereas for eight or ten guns a wide plain or long ridge of a hill will alone ensure equal distribution of sport, a narrow gorge or small projecting point may facilitate the concentration of birds upon two or three guns. The more it is required to concen-



A Battery.

trate, the more important become the functions of the drivers on the flanks in proportion to those of the centre line. Rightly to determine the best position for a line of guns, it is most necessary to observe the natural habits of flight in the grouse, and to be aware of any special modifications of such habits owing to the physical features of the ground.

Grouse, except when engaged in feeding, like to be able to look

about them. The old birds are fond of sitting on walls or hillocks, and will be seen at a distance, holding their heads erect and gazing around. Especially when disturbed they seek the ridges of hills, whence they can detect the approach of danger at a considerable distance. When walking in thick heather, with or without dogs, for every bird so found large numbers will be seen rising in the distance and escaping over the nearest sky-line.

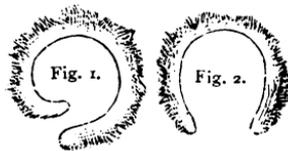

Diagram of Batteries.

For this reason, in driving a hill towards a plain or valley, the packs of grouse are likely to diverge laterally, keeping to the higher ground ; whereas, in driving a plain or valley towards a hill, they will more readily maintain the required direction. Where great stretches of flat moorland are to be found well stocked with birds, they may be driven backwards and forwards over a line of batteries placed on the level, even although the batteries are visible from a distance.

But in hilly or uneven ground it is always preferable to drive along or towards a ridge, and to conceal the batteries as much as possible behind the rising ground. They should be placed in such cases about sixty or eighty yards behind the sky-line, so that birds coming over it may be within, or almost within, shot before they are aware of the danger. In this there is a double advantage : first, that the birds more readily come within range ; secondly, that on reaching the summit of a hill their flight often becomes slower, as they think of alighting as soon as they are out of sight of the drivers. The gain is not so much in the easier shots obtained, as in the facility afforded for using a second or third gun before they have made up their minds to increase their pace. Birds flying low along a ridge will usually take a line on one side or other of its highest level, and, following to some extent the configuration of the ground, will sweep round projecting points or bends of the hill, seeking the summit only with a view to pitching. In nearly all cases the best place for a battery is within shot of such pitching points, as far as they can be ascertained. Gulleys and water-courses are often convenient to conceal the guns, either with or without batteries. Where these are on steep side-hills, however, so that the highest and lowest guns are on widely different levels, it will be usually found that the shooting is unevenly distributed, those who command the most probable pitching place, either on the turn of the hill at one end of the line or towards the summit at the other, being likely to get the best of the sport. The batteries, whether on high or low ground, should be as much as possible on the same level, and, if only

for the sake of safety, they should be in true line with each other ; eighty or a hundred yards is a fair distance to separate them.¹

Where, owing to any inequalities in the ground, one battery is not distinctly visible from the next one to it, a turf wall should be erected half-way between them, not so much as a screen to catch the shot, but rather to indicate the line in which it is never safe to fire. Where the positions in which they should be posted are ill-selected, guns are often placed in such a manner as

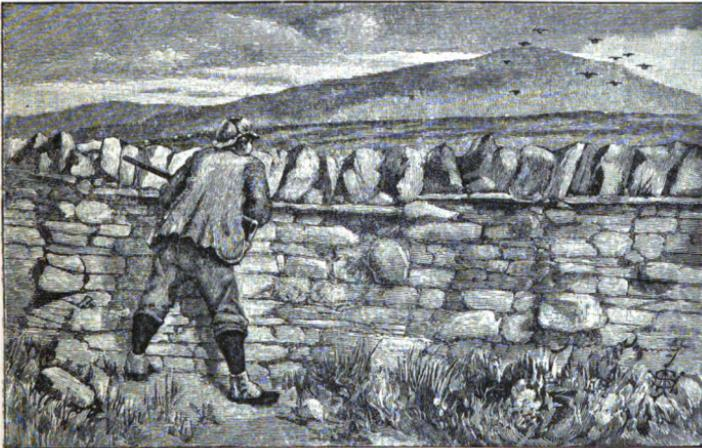

Grouse Driving in Derbyshire.

to turn approaching birds before they arrive within range ; this would, for example, be the case if batteries were built in exposed positions on the summit of a hill. Birds coming up the hill towards them would inevitably see the smoke of the guns and the heads of the shooters, and many would turn back over the drivers. On one occasion, at High Force, the writer can well

¹ The present Duke of Roxburghe was shot in the face by the seventh Lord Chesterfield, and hit so hard that the blood ran down over his Grace's shirt, at a distance of 180 yards, carefully measured with a ball of string by myself. A pellet once went through my own glove, and drew blood, at 136 yards. There should be some sort of screen between all batteries.—ED.

remember a case in which the guns were placed at the bottom of a valley between two high hills, over one of which the drivers were advancing towards the other, in the expectation that the birds would dip into the hollow and rise again on the other side. What happened was simply this: they crossed over the valley from one side to the other without lowering in the slightest degree the level of their flight. A distinguished sportsman and first-rate shot in the next battery declared them to be quite out of range and ceased firing. It was in the early days of breechloaders, but his neighbour, who was fortunate enough to be using muzzle-loaders, by increasing his charge of powder and putting in rather less shot, was able to bring to bag fifteen of the highest rocketers he ever saw killed. This was, perhaps, the one advantage of muzzle-loaders, that under special circumstances the charge could be varied at a moment's notice, to secure greater penetration at long distances.

In some places it is customary to establish a double line of batteries, that those birds which escape the foremost guns may have to run the gauntlet a second time; but the effect of this arrangement is very embarrassing, besides being dangerous. You have to keep in your mind and in your eye, not only the one direction on each side, but also two or more other angles behind or before you, at which it is not safe to fire, and if for an instant, excited by a crowd of birds, your nerve or your resolution to be careful should give way, a dropping pellet may cause some one the loss of an eye. Moreover, when you come to picking up, the ownership of running birds is liable to become, in transatlantic phrase, 'badly mixed.' Loaders not unfrequently fall out about the possession of towering birds, and their masters occasionally follow suit. When in the course of a drive, two or more wounded birds happen to fall about the same spot at a distance behind the batteries, the position of each will be mentally noted by the man who has struck it, and when he or his deputy goes to pick it up, the principle of 'first come first served' may lead to a pretty quarrel if the scorers in quest do not happen to know that

more than one bird has fallen. A warmly-tinted report by one, of the proceedings of the other, will arouse the pardonable indignation of his superior, and if this be not set at rest by the obvious but too often neglected expedient of going again to look for another bird, it may lead to unpleasantness or dispute, requiring the *amende amicale* of at least a box of cigarettes from the one who has most visibly or audibly lost his temper.

Touching the question of this same picking up, it forms no small or unimportant part of the day's work. In some places, to avoid mistakes, a fixed rule is established that no bird can be claimed by any gun which is not gathered on his own side of a line drawn, measured, and permanently marked half-way between his battery and the next in line. The effect of this is that, if you kill long shots or wing birds, your neighbours add them to their score, and although such a system may prevent disputes, it is scarcely likely to allay jealousy. Those who are accustomed to driving have usually no difficulty in remembering how many birds they have down at each drive, and by comparing notes with their neighbours before the birds are gathered they are able to see that all are picked up, or at least searched for; whereas, if they may claim nothing beyond the dividing line, so soon as there is any difficulty in finding a bird they are apt to give it up, on the chance of its having run beyond bounds; and thus many dead birds will be left in the thick heather, if there be any where the drive takes place. To avoid this, it is always desirable to burn off the heather for fifty or a hundred yards in front of and behind every line of batteries. Another fixed rule adopted on some moors is that no shot is allowed to be fired except from the battery itself. Although this may be necessary in the case of those on whose sportsmanlike instincts and discretion it is impossible to rely, it should not be so with those who know their work. One who, in his anxiety to secure a wounded bird after the drive is over, will fire a dangerous shot when men are scattered around, or will disturb the ground about to be driven by ranging too

far back in search of cripples, should be made to understand that he is not the only member of the party who has to be considered. But to allow wounded birds (and among large numbers there must occasionally be some touched which do not fall dead) to remain on the ground, or to rise again and flutter away to die elsewhere, is not only cruel but wasteful. Even at the risk of disturbing fresh birds, one which has been hit should be secured if possible, and a true sportsman will devote his attention especially to this object if allowed to do so. Such an one will always be careful not to go too far. He will not show himself over the ridge of a hill at the risk of putting off fresh birds. He will not follow up untouched birds that have pitched behind him for the sake of increasing his bag, if by doing so there is any chance of interfering with the sport of his companions. Such 'marauding' tendencies cannot be too strongly deprecated in a general way; but, as it has been attempted to show, some men who know what they are about may do much good and no harm by seeking wounded birds.

A couple of good retrievers are the best dogs for this purpose. The writer once possessed an old close-ranging Spanish pointer, to whose steady work and excellent nose he owed a number of birds which would have otherwise been left unfound. If nobody was looking at him, he would sometimes bring a dead bird, but always with his tail between his legs, as if ashamed to have usurped the functions of his curly-coated black rivals.

It is important that each gun should count the birds he has down as correctly as possible at every drive. Unless this be done, he will be unable to judge how much time it is worth his while to spend in searching for them. The difficulty of reckoning is not great when the numbers are small; but to those who are not in the habit of counting it is by no means easy to keep an exact mental record of a large number of birds killed.

It will be found useful, as each bird falls, to mention audibly the number down, as by this means the loaders or other attendants will be enabled to check the scorer; but as they must

keep their heads out of sight below the battery, they cannot themselves be made to keep count. A little indicator, which can be fixed on the woodwork of the gun under the barrels, has lately been introduced into the market by Sir Ralph Gallwey.¹ It can be easily worked without shifting the hand, and would probably be of great use to those who require some such assistance in counting.

In the event of towering or other wounded birds falling far behind the battery, their position should be carefully observed by the loaders, who can look back although not forward. In such cases it is useful to make a mark to indicate that a bird is to be looked for in a certain line; this can be done very simply by setting up an empty cartridge-case in the soft ground and bearing in mind some conspicuous object in the far distance, so that the bird may be found by walking straight towards that object. The cartridge-case may be sloped so as to indicate the proper direction, or a short line may be drawn with a stick upon the ground for this purpose. Mr. Speedy² gives a serviceable diagram showing how the position of all fallen birds may be marked on a piece of paper, but to carry out this plan someone besides the shooter must be constantly putting his head above the battery, which is undesirable, and must indeed attend to nothing else but marking. With birds falling close at hand it is sufficient to keep count of the number down.

The great variety of heights and angles at which driven grouse will pass the guns renders this kind of shooting more interesting and more exciting as regards the required exercise of skill than any shooting over dogs.

A pleasing variety is sometimes afforded by far-sailing black game, or high twisting snipe, both of which demand an extra amount of faith and science. The idea that such sport must be tame and monotonous will not be entertained by those who have enjoyed it.

¹ See vol. i. p. 46.

² *Sport in the Highlands and Lowlands of Scotland*, p. 174.

A high wind behind the birds adds greatly to the difficulty of keeping up a good average of hits and misses.

Although a grouse does not move its wings so rapidly as a partridge, the number of wing-strokes in proportion to the distance traversed being decidedly less, yet the impetus acquired by the heavier bird in its longer flight, and frequently with the advantage gained in descending from high ground, teaches a good lesson in the art of holding forward. It is not unusual, in firing long shots at birds crossing on one side or the other, to see the bird aimed at go away untouched, another bird perhaps, two or more yards behind it, falling to the shot. When this has happened once or twice to an inexperienced hand, he soon learns to correct his aim, and to allow a sufficient distance in front for the bird to meet the shot at the proper angle. A large proportion of grouse shot at will probably be low skimming birds, almost touching the top of the heather in their flight. Such birds, if they see any moving object above the edge of the battery, are quick to change their course, and often turn away at an angle just as the trigger is pulled. These should be killed before the turn if possible, but are, of course, easier to hit after it than at the moment of turning. Another lesson is often learnt in shooting at skimming grouse. When the heather is wet the shot will be seen to strike if aimed beneath the bird; and when the spray clearly indicates the error it is more likely to be corrected. Great care should be taken never to fire at a bird coming straight towards the gun at such an angle as will cause it to fall in the battery. It is no joke when a grouse falls on a man's head. Estimating the weight of the bird and the pace at which it is travelling, it would be easy and interesting to calculate the exact equivalent of dynamic force exercised by a direct blow. It is sufficient for the present purpose to indicate the danger, and to assure the reader that men have frequently been knocked over and more or less stunned by such an accident.¹

¹ The late Mr. Charles Leslie was knocked clean out of his battery on a windy day by a grouse he had shot. Fortunately, he had a very strong hat, on the front of which the bird fell.—ED.

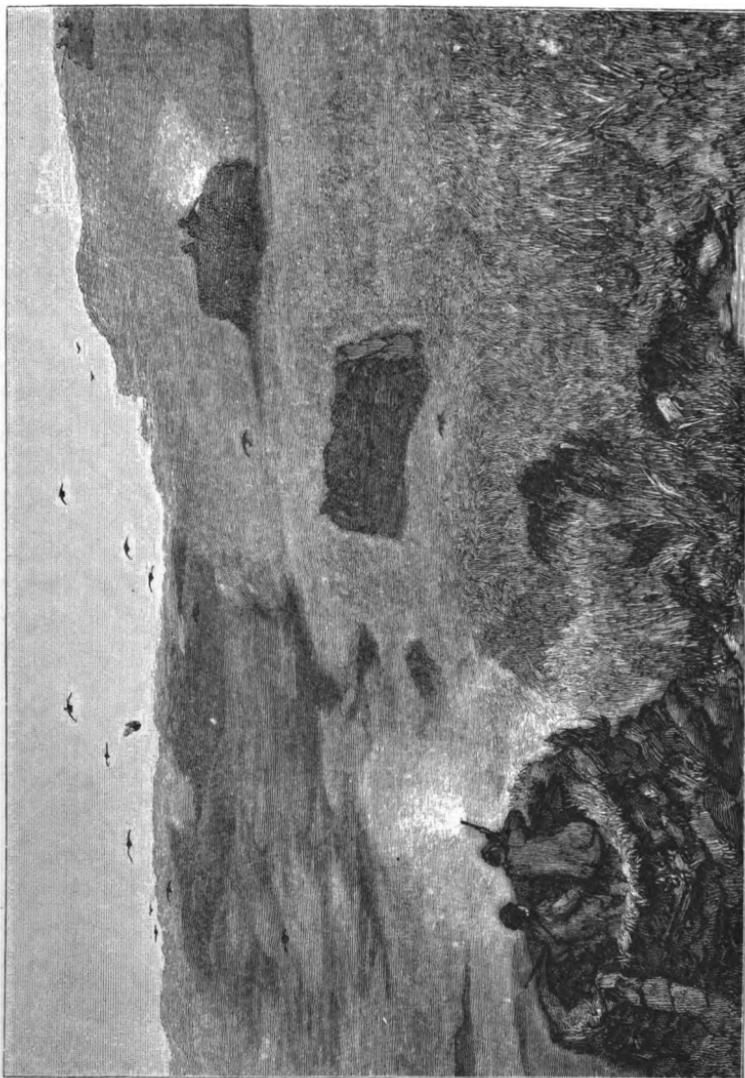

GROUSE DRIVING

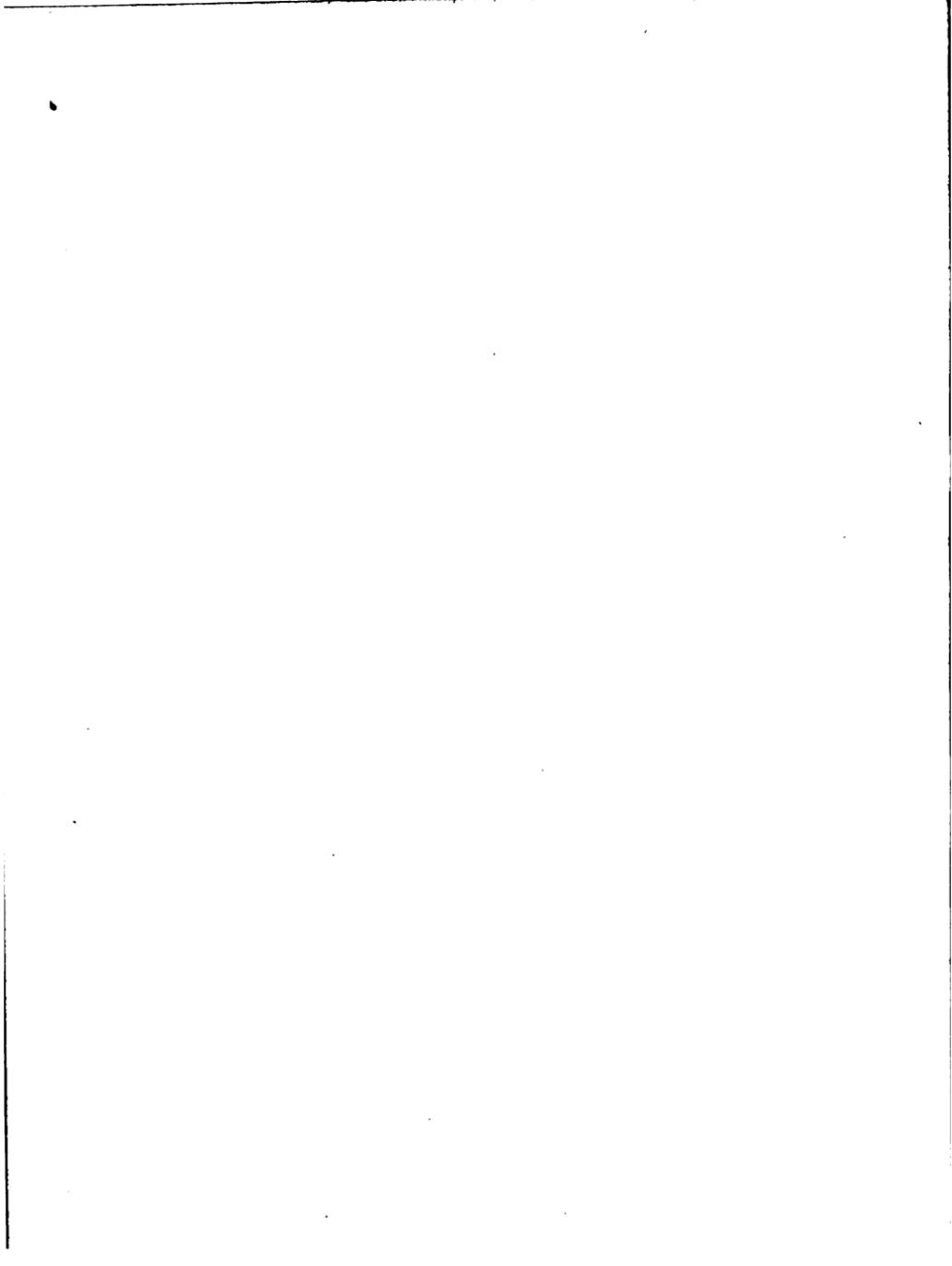

In one case it is within the writer's recollection that a driven grouse fell upon the muzzle of a full-cocked gun standing against the battery ready for use, and knocked it down with such force that it was a matter of surprise that it did not go off. Had it done so, the direction in which it fell must have caused a serious accident to a lady who was looking on at the sport. Birds coming straight towards the battery should be dropped either immediately in front of or immediately behind it. A practised hand will never fail to take them only at such angles as will ensure this result.

If two birds are flying level with each other and towards the gun, it is believed to be impossible to drop them both in front of the battery with the right and left barrels, unless they are coming against a strong wind.¹ They may both be killed in front, but the second is sure to fall behind the line of fire. A good deal of skill and practice is required to select from among a number of birds the one that should be first shot at. This should properly be the one that first comes within easy range. This bird may possibly have time to escape if another is taken first, and it may happen that no third bird is available for a second barrel. The master of the art will not fail to score two in such cases where the killing of the second depends upon a right selection of the first bird. Many a young hand, with a view to increase his bag, will occasionally attempt to fire into the 'brown' of a passing pack—in this way he may possibly kill one or more; he may not improbably wound some without killing any, but the far more usual result will be that the shot has no visible effect on any. A good shot can occasionally, by carefully waiting his opportunity, kill at one discharge two birds flying parallel with each other. But in watching for such a chance he will lose useful time, and in shooting driven grouse,

¹ At High Force, in the juniper drive, five grouse were once coming towards and rather across me. I saw that the second was flying faster than the first bird, waited and got both in line, and catching the other two also in line, got the two brace with two barrels. The fifth, seeing his friends fall, pitched, and clapping my hands to make him rise, I killed him with the first barrel of the other gun, thus dropping the five with three barrels.—ED.

however large the packs may be, two birds are seldom and more are rarely killed at one shot.

In Scotland, especially on very hilly ground, a brood of grouse will frequently rise all together as the sportsmen appear over the sky line. In doing so, if on a side wind, each bird is likely to take the utmost advantage of the elevating power of the wind, and thus there is a general tendency among them to turn at the same moment and to fly parallel with each other.

In such cases there occur frequent opportunities of taking two or three birds exactly in line with each other at the instant of turning—so in walking, the chances of killing more than one at a shot are more frequent, in proportion to the shots fired, than in driving.

If we come to discuss the question of *how* it is done, we touch upon several matters not especially connected with the subject of this chapter. A merely crude indication of the way to do it can be given here, for it must be remembered that success depends far more upon long habit and experience than upon the observance of any rule whatever, even if rules can be at all laid down. It will be very frequently observed that some men kill a much larger average of shots at birds flying to the left than to the right. This is often the case when the shooter is in the habit of shutting his left eye ; but it would not be safe to argue that those who habitually fire with both eyes open find less difficulty in holding well forward at a right-hand bird.

Although with those who shoot from the right shoulder the direction of the gun is always mainly regulated by the right eye, there must be a great advantage in acquiring the power of keeping the left eye open, without allowing it to interfere with the aim. A wider range of vision at the moment of firing is secured, and another object can be more readily selected for the second barrel. Accuracy and rapidity in shooting really depend more on the act of putting the gun to the shoulder, than upon what movement is given to it after it is there. A man who is accustomed to aiming will be able to point a gun or even a stick from his shoulder straight to a

given object by the almost instinctive, because finely trained, position of his left hand, which, in adjusting it, is elevated exactly to the right degree. This he will do without lowering his eye to the same plane as that in which the weapon lies, but holding his head well above it. The proof of this proposition can be found in the fact that many men shoot well after it has become too dark to see the line of the gun, and when their only guide must be the more or less indistinct recognition of the object fired at. Moreover, if a gun is let off before reaching the shoulder, as especially in the case of quick shooting at rabbits, the object aimed at is frequently struck, and this can only be by the trained perfection with which the brain guides the hands to give the required direction to the gun while the eye is simply fixed upon the object.

It is the business of the eye rapidly to instruct the brain as to the pace, distance, and direction of the bird, mentally to determine the exact spot which will be reached by the time the gun can be pressed to the shoulder. The hand should obey the brain in directing it to that spot and correcting any inaccuracy at the moment of firing.

The rapidity with which the trigger can be pulled will depend, if we may use the term, upon how much mutual confidence exists between the three organs of sight, sense, and touch.

The left hand should be thrown well forward along the gun, nearly to the full extent of the arm. By this means greater leverage is obtained, and the movement can be quicker than if the hand is held near the trigger guard.

The system of holding a gun with the left hand close to the locks has probably descended from the days in which it was not unusual for guns to burst, but the risk of accidents of this kind is now sufficiently reduced to make it no longer a necessary precaution against injury from the bursting of a barrel.

In shooting driven birds, select without hesitation, as they approach, that one which will first arrive within good killing

range. Put the gun to the shoulder quickly as he reaches the required spot, directing it at his beak or well away in front of it, according to the angle of his flight, the pace at which he is going, and the distance the charge has to travel. If this is done correctly, the trigger may be immediately pulled. If adjustment is seen to be required, it should be as instantaneous as possible, and will almost invariably consist of a quick swing forward to keep pace with the bird. As the trigger is pulled,



A Grouse.

(From a photograph by Lord Walsingham.)

there should be no unsteadiness, no lifting or lowering, no flinching or jerking.

If the gun is in motion at the instant of firing, the movement should be maintained until the shot has left the muzzle; if it is stationary, the recoil should not be allowed in the slightest degree to change its direction.

As you pull the trigger, the eye should take up a fresh object, and the operation should be repeated; a man with good sight need not wait to see the effect of his first shot. He will be aware of this at the instant of firing, as it is well

known that images are retained upon the retina for an appreciable moment after the eye is diverted.

There is really little more to be said on this subject. Success must always depend upon practice, so long as right principles are followed. Unless a bird is going straight away, he should fly into the shot, and the object is to get it there in time : it will be easily understood that those who put the gun in the right place *by first intention* can do this more rapidly than

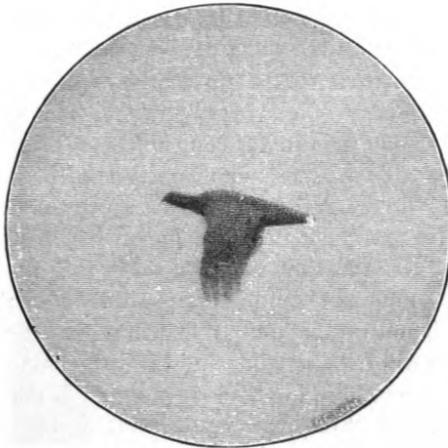

A Grouse.

(From a photograph by Lord Walsingham.)

others who aim first at the bird, and then adjust by swinging forward. A man should know how long it will take him to get ready to fire ; and if one yard or two yards of a bird's flight will not give him time enough to bring his gun to bear, he had better prepare to direct it five or six yards ahead if necessary, so as to get it to his shoulder exactly at the right moment for firing, rather than aim first at the bird, or behind it, and then attempt to intercept by following it. In long crossing shots, a lateral motion given to the gun may sometimes facilitate shooting well in front ; but in this case the lateral motion should be

commenced (partly by a turn of the body) in the act of raising the gun ; the motion may be continued if found necessary, but for as short a time as possible, after it comes to the shoulder, and in the act of firing ; but it will probably be found that a man who is a good and quick shot will, in grouse driving at least, fire a much larger percentage of shots without giving any swing to the gun after it reaches the shoulder than otherwise.

It will be found convenient, to ensure rapidity of shooting, not to depend upon changing guns from the loader's hand. Where two or more guns are in use, those which are ready loaded may be placed leaning against the battery in a convenient position to be taken up as required. As the empty gun is handed back to the loader by the right hand, the loaded gun may be grasped by the left hand at such a distance from the stock as will enable the sportsman to raise it to his shoulder without shifting his hold. A thoroughly trustworthy and experienced loader may be allowed to cock the guns when placing them in position for use. But even with the safest and most practised of men the hammers should be raised only after the guns are firmly placed, and not before. When the drive is over, a careful sportsman will take his guns and bring the hammers of each to half-cock before allowing his loader to touch them.

More guns are let off by accident in the process of dropping the hammer from full to half-cock than in any other way, especially on a cold or very wet day, when the sensation of touch is numbed or the skin is slippery from damp.

A sporting critic will perhaps remark that in describing what goes on in the battery before giving some account of how the birds are to be brought there, the cart has been placed before the horse. Without flattering ourselves that he will discover no more grievous faults, we may accept the impeachment, and revert to that first important part of the subject.

It has already been remarked that in many cases, either owing to the configuration of the ground or to the attraction offered by adjacent favoured haunts, the tendency of grouse to escape at the sides of a drive makes the outside drivers of more

importance to success than those in the centre of the line. To so great an extent is this the case that the best and most experienced men should always be entrusted with the duty of guarding the sides. A line of drivers should assume the form of a huge horseshoe, and as they advance, although the figure should be gradually and evenly contracted, it should scarcely at all be changed. The only alteration will be that the curve of the line will become more and more shallow until the guns are reached.

The side drivers should be placed in position before those who are to move the birds begin their march. According to the amount of ground included in the operation and the number of men employed, their distance from each other must be regulated.

On most of the English moors ten or twelve men will be found sufficient to cover effectively a drive of a mile in length and half a mile in width ; but fifteen or twenty will better ensure raising all the birds from thick heather, and will also better protect the flanks. In moving birds from high to lower ground, as from the long ridge of a hill, some will be sure to shape their flight in a lateral direction at a considerable height above the heads of the flanking men. No amount of shouting, which is always useless, and no waving of flags will turn such birds ; they will take their own line and keep it, in spite of all obstacles or supposed dangers below them.

It should be an object as far as possible to the centre men to keep their line in such a shape as to make the birds fly straight forward. For this purpose it must not be too straight or too much curved. All the men composing the centre of the line should be visible at the same moment to birds rising or intending to rise, and the influence exercised upon their direction by the degree of advance of each man should not be more or less than is required to push them forward.

If a man in the middle of the line walks in advance of the others he acts as a wedge, turning close-lying birds to his right

or left ; or, becoming visible before his companions, he turns others at a distance by indicating a danger only from one single point. In the same manner, if the right-hand or left-hand man of those who should be equally visible to the birds be too far in advance, his position will tend to turn the birds in the opposite direction to himself. When grouse rise from the advance of the central line, the men immediately to the right and left of the centre should become at once visible to them ; and as they fly forward they should begin to see the advanced men on either flank, not before they reach them, but as soon as they come to be on a level with them. If they see them too soon, unless at a great distance to one or other side, they will be apt to turn back to avoid them, and much care is required on the part of the flanking men to place themselves so as to become visible only at the proper moment. A driver who knows his work will frequently watch the sky-line to see when birds are on the wing towards him, and will stoop or lie down until by raising himself he can direct their flight as required, knowing that should he stand up too soon they will rise above him or turn away. The writer has often found it useful, especially on the point of a hill, to place a careful man behind the line of fire. Birds that hug the hill-side and would pass the battery out of shot are frequently turned towards it, even although behind it, by such a man showing himself at the proper moment ; and the same effect may even sometimes be produced by small flags judiciously placed before the commencement of the drive. In the hands of men who understand their work flags are decidedly useful to drivers, often enabling them to change the course of birds in the required direction from a greater distance before they have too decidedly determined to go wrong. But, on the other hand, the fact of rendering a man more conspicuous by giving him a flag enables him to do double mischief if he shows himself too soon. The foregoing remarks apply more especially to difficult and uneven ground. On long even plains, or valleys between commanding hills, all the drivers may be in sight at once, provided they keep their

relative distance from each other and maintain the correct shape of the line. On such ground it is only necessary to place at intervals among them some few experienced directors, who will call a man to order should he hang back or advance too much to the front, and in this case driving is comparatively easy.

A pack of grouse, if they discover the presence of the guns in front of them, will sometimes, when flying low, turn back, and after making a complete circuit of the line of drivers come on again to the guns. When this happens it is a pretty good proof that every man is in his right place; for if there be a weak place in the line owing to the men being at unequal distances from each other or to some one of them hanging back behind his fellows, the birds will probably break through and escape. It is satisfactory to see them taking fresh directions from each flag as they approach near enough to be influenced by it, and eventually sweeping on for the second time towards the firing point. Sometimes two large packs will meet in mid-air, and single birds among them will audibly cannon against each other¹ and perhaps lose their balance for the moment.

Many a drive has been spoilt by a hawk, or even more frequently by a heron mistaken for a hawk, passing across it and moving large packs in a wrong direction. On two occasions the writer has observed great numbers of birds leaving a moor before a balloon, floating at no great elevation above it.

One point which has not been touched upon seems to require a word of caution. When batteries are placed, as they should be, behind the sky-line, it will be impossible to see when the beaters approach within shot, and they should be directed to make their voices heard as they approach the shooters. Dropping shot will fall over a hill and may cause accidents, even to a distance approaching 200 yards. Great care should be exercised against incurring such risks, and where a doubt

¹ On the late Mr. Henry Savile's moor at Ryshworth, I once saw two grouse kill each other in a high wind by colliding. I picked them both up.—ED.

exists the men should always have the benefit of it, and the bird should be shot after passing the battery.

It will probably be admitted that No. 5 is the best size of shot to be used for driven grouse, but owing to the different degrees of velocity with which shot of different sizes will reach the object aimed at, the choice must depend much upon habit. Each individual sportsman should know for himself with what size he is accustomed to make the best practice.

No. 5 will certainly break a bone, and therefore bring down a bird at a greater distance than No. 6 ; but as an ounce of the latter contains, of course, a larger number of pellets, the same weight of No. 5 will fly thinner, and give in that way a better chance of escape when the aim is not absolutely true.

Grouse driving affords much assistance to a study of human nature. The different characteristics of individual sportsmen are strongly marked by their demeanour under various circumstances. We find among them several types. The most distinct of these are the habitually fortunate and the habitually unfortunate men. There are those who, wherever they are placed, whether by lot or by selection, seem to others to get the best of the shooting—so much so, that they are jokingly credited with some mysterious power of attracting the game. There are those who, on the contrary, are certain to complain that they have been most unlucky. They will call attention to the fact that others have had more shooting than themselves, and wonder how it so constantly happens that they never get the best of the luck. A parallel line of contrast may be drawn between those who are satisfied and contented wherever they are placed, and those who, if left to their own choice, would prefer to take any other place than their own.

Some prefer to shoot only at the birds nearest to them and to leave those at a distance to their neighbours. A few are yet to be found who habitually shoot what is nearer to their neighbours than themselves, when they can get their guns off quick enough. In shooting, as in other occupations, the rule that good luck follows good management is almost invariable. The

number of grouse killed by any one gun in a drive do not depend solely upon the number of his opportunities, but on what use he makes of them. Many a man will say, 'I had only thirteen shots and I killed twelve birds, I could not have shot better;' but this does not at all follow: he calls attention to the twenty birds killed by his 'lucky' neighbour, but perhaps omits to notice that his neighbour changes his guns by several seconds quicker than he does, and pulls the trigger the moment his gun comes to the shoulder, instead of dwelling on his bird. The man who gets off twenty-three shots where another would only fire thirteen during the passing of the same quantity of birds, can afford to miss a larger proportion, and will yet head the score. Some men see birds coming with much more certainty than others; but to allow a bird to pass unseen can in no way be attributed to a want of luck. Many more things have to be taken into consideration, to account for each man's share in the ultimate result of the day's work, than mere accuracy in shooting, although this must of course count for a great deal.¹

Most people are anxious to make out that they have made as much of their opportunities as could reasonably have been expected. Such remarks as the following are common—in answer to the usual question, 'What did you do in that drive?' 'I only had seven shots, I killed six.' 'I got ten; I couldn't have killed more than twelve anyhow.' 'Sixteen down, the others were all long shots.' A joker was once heard to cap such statements: 'I got three, I only *saw* one.'

There are certain spots on some of the Yorkshire moors where it would be instructive after many years' shooting to analyse the contents of the soil and discover the amount of lead it contains. Such mining could not be expected to be remunerative, but would probably yield some curious results. What,

¹ A gallant captain at Ryshworth, complaining he had not had a shot, old Sykes the keeper exclaimed, 'I see'd the reek [smoke] six times myself, and I don't like yon captain, he's a cross-faced little chap.' Poor Josy Little, the best tempered and most cheery of men!—ED.

again, will be the reflections of the archæologist of the fortieth century when he finds in the coal measures of the future (if our peat of to-day is ever destined to resemble coal) curious collections of the brass bases of our cartridges, evidently of human manufacture, imbedded in their substance? Will he believe that this deposit of ancient fuel has already been worked, in bygone days, by the explosives of the miner? or will it reveal to him, after much literary research, a true vision of the youthful sportsman dancing upon his empty cartridge cases and jamming them into the soft ground to conceal the woeful measure of his discomfiture? Will he picture to himself the self-satisfied smile with which 'Mr. Twelvin Twenty' has announced his bag, after carefully disposing of six out of eight unsuccessful tell-tales? And how will he interpret the mystic legend, 'ELEY BROS.?' We may satisfy ourselves with the thought that he will be indeed a lucky man if his enjoyment of life can be enhanced by any such glorious and thrilling sport as that of which he may find the relics.

It would be easy to give a long list of remarkable bags of grouse, but a few will be sufficient for the purpose. Some of the best bags made over dogs were probably on the late Lord Dalhousie's moors at Brechin Castle, Forfarshire.

Greener ('The Gun and its Development,' p. 535) states that—

The largest bag (of grouse) made over dogs was by the Maharajah Duleep Singh at Grantully, Perthshire, on August 12, 1871. His Highness used three guns, and only one pair of dogs working at a time. He commenced at five o'clock, and continued until late in the afternoon. The result was 220 brace of grouse.

On General Hall's moor at High Force, on the Yorkshire side of the Tees, many remarkable bags were made by driving before the great year of 1872. In 1866 eight guns killed from August 13 to 17, 1,185, 975, 667, 533, and 872.

In 1872 the largest numbers were reached. In this year 2,856 birds were killed over dogs at Dalnaspiedal by four guns: Earl of Dunmore (his first shooting after the loss of one eye),

Viscount Newport, Mr. Forbes and Mr. G. Forbes, in five days, the largest bag on any one day being 870, on August 13. By driving on Mr. Rimington-Wilson's moor at Broomhead, in the West Riding of Yorkshire, 2,626 grouse were killed in one day by eleven guns.

At Studley Royal, on Lord Ripon's manor, 2,240 grouse are stated (*Morning Post*, Saturday, August 12, 1882) to have been killed in one day. These numbers have, we believe, been more correctly recorded as 2,080. The bag was made by seven guns, who also killed 1,800 on the following day.

At Wemmergill, in 1872, over a thousand brace were killed in a single day, and at High Force¹ on August 12 and four following days, ten guns killed 1,616, 1,782, 954, 1,348, and 1,362. The writer is indebted to Sir Frederick Milbank for some interesting particulars of the shooting on his moors at Wemmergill, where the drives were laid out on an improved system by his keeper, Joseph Collinson, in 1863. On this moor the largest collective bag in one day was 2,070 to six guns. No less than 17,064 were killed in the season 1872; and the average of the last twelve years' shooting has been 4,133 birds in each season.

The largest number of grouse killed by one gun in a single day was 842, on August 28, 1872, by the writer, shooting alone at Blubberhouses, in Yorkshire. He made use of two batteries only alternately throughout a day of rather over twelve hours. The discussion of this day's shooting has frequently given rise to the remark, 'What a selfish proceeding!' But if a man asks in every season as many friends as his moor will hold, he should surely not be accused of selfishness if once in ten years he takes a day to himself, if only to try what can be done. On the occasion referred to twenty drivers, divided into two parties of ten each, were employed, the number of drives accomplished being sixteen, and the guns used two muzzle-loaders and two

¹ In 1872 at High Force, then occupied by the Editor, an average of eight guns shot 19 days, spread over August, September, and October, and bagged 15,484 grouse.

breechloaders. It may be mentioned that forty-two and a half brace, or eighty-five birds, was the largest number ever killed by one gun on this same moor over dogs. This was in 1864, and was only accomplished by very hard walking, and by taking advantage of every hillock or ridge of rising ground to get within shot of birds which on the level would have risen far out of range. The dogs were practically useless, except during very hot sunshine in thick bracken at the early part of the day.

A far more remarkable individual bag was that of Sir Frederick Milbank, who, as one of a party of several guns, himself succeeded in bringing to book no less than 728 birds in a single day, also in August 1872.

PTARMIGAN.

To those who enjoy climbing and rough walking ptarmigan shooting offers special attractions. There are not many places where it can be enjoyed in perfection. Nearly all the best ptarmigan ground forms part of some carefully preserved deer forest, and no one who rightly appreciates the advantage of keeping deer quiet and undisturbed would willingly sacrifice his sport in this respect for the sake of any bag of smaller game. At the same time it should be borne in mind that deer usually seek the sheltered corries, and do not willingly frequent the highest and most exposed situations, such as those bare rocky and stony peaks where ptarmigan are most abundant. Moreover, deer soon discover the difference between disturbances of the forest when they are the objects of pursuit, and when there is no design against their safety. The injury to the interests of the deer-stalker inflicted by a few shots at ptarmigan on the high peaks is very frequently exaggerated by a too lively imagination; but under unfavourable conditions of wind, in too close proximity to a neighbour's march, it is better to err on the safe side, and to leave the birds in peace rather than risk the loss of more valued game.

Weather permitting, you are always sure to find ptarmigan in their favoured haunts even after deer-stalking is over ; but it will not be safe to count upon making a good bag after the month of September.

The changes of plumage in ptarmigan afford these birds at different seasons a remarkable degree of protection against their natural enemies. No one who has seen them in their native haunts, be he naturalist or sportsman, or the more happy combination of both, can have failed to be struck by the perfect resemblance of their colour to the objects by which he finds them surrounded. The first time he makes their acquaintance he will probably see them at from ten to fifteen yards distance, where the short jerking motion of their tails will first attract his attention as the birds walk along among the stones, and he will wonder how he could have been so near them without noticing them before. So long as they remain motionless they are most difficult to see. It is well known that the complete change of colour from blue grey to pure white, which is commonly called the assumption of winter plumage, is not effected by any process of moulting. The dark pigment disappears first from the tips of the feathers, and often remains about their bases long after it has ceased to be visible when the plumage is undisturbed. Great as is the protection afforded by their assimilation to lichen-covered rocks in summer and to snow in winter, there is little doubt that ptarmigan, like other Arctic birds and animals which nature has enabled to dispense with summer pigments, derive a further advantage from this change. As white is the colour which most slowly absorbs heat rays, so by the laws of radiation it is also the colour which most slowly radiates heat ; thus these birds are much less easily deprived of the natural warmth of their bodies in winter than they would be if still clothed in darker plumage. Here then is a double provision of nature for their advantage, acquired by one and the same process of change. The plumage which best protects the bird from observation, and therefore best guards it against predatory vermin, is also that which is best calculated to enable

it to withstand the severities of climate in the exposed situations which it frequents. In summer, again, it retains its full measure of protection through the deposition of pigment, probably by some process analogous to the oxidation of cellular protoplasm in plants under the influence of warmth, while at the same time it is enabled more rapidly to absorb and radiate the heat of the sun, and thus readily to adapt itself to altered atmospheric conditions.

Mr. E. T. Booth, in the catalogue (p. 72) of his very charming museum of British birds on the Dyke Road, at Brighton, gives some curious illustrations of the difficulty of finding the hen ptarmigan when sitting on her nest. Mr. Booth relates his experiences in endeavouring to obtain a specimen for his collection, and records how, after a long and futile search for a nest of the bird, his dog, moving less than a yard from where he had been lying, actually resettled himself on the back of a sitting bird, which formed almost the centre of a group of men and dogs who had been reclining around it unawares for some length of time. He also relates how on the same day another sitting hen was discovered through one of the pannier straps falling on her back between the legs of the pony as the lunch was being repacked, after a protracted search for the nest everywhere except under the pony.

In fine weather, as already mentioned, it is not unusual to walk within a few yards of ptarmigan, and to see them running on the ground in front of the sportsman. At such times they may well be compared for tameness to chickens in a farmyard, and one would feel ill repaid for the great exertion probably required to arrive at the shooting-ground, were it not for the special charm attaching to any sport amid such wild surroundings. If the weather should suddenly change and become wild and windy, all compunction at knocking over birds which appear to be so easily approached vanishes. The nature of the quarry undergoes almost as sudden an alteration as the weather itself; instead of running complacently along the ground, apparently regarding dogs and sportsmen as curiosities rather than as

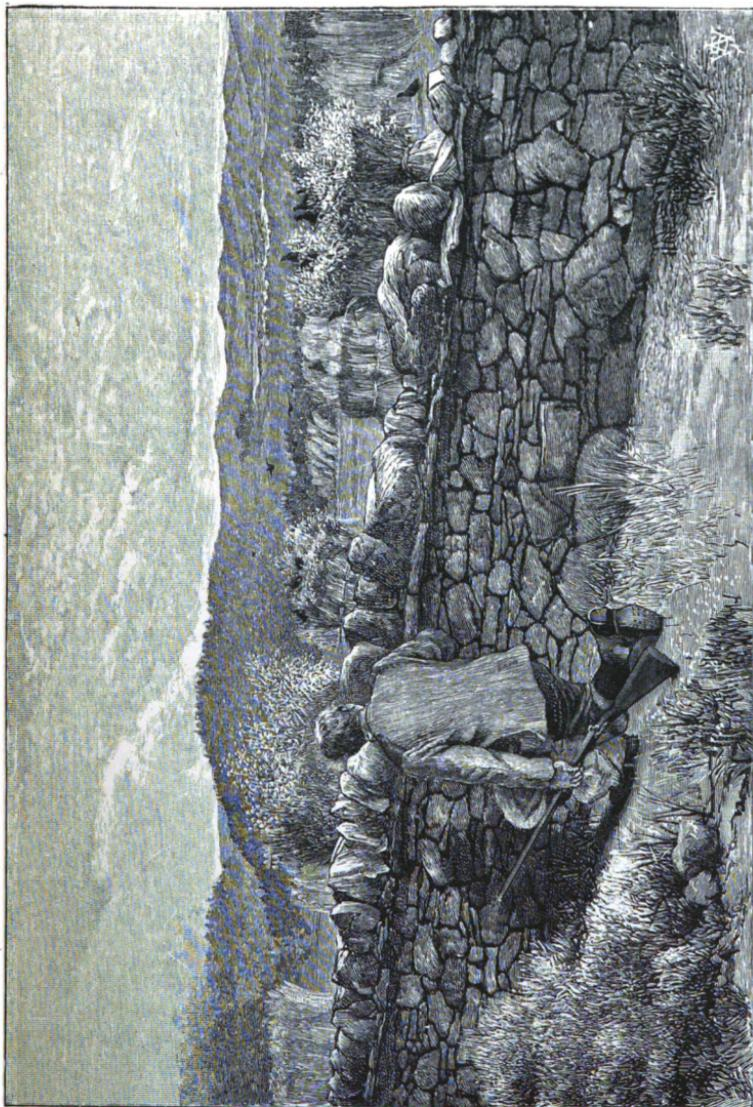

STALKING GROUSE ON THE STOCKS

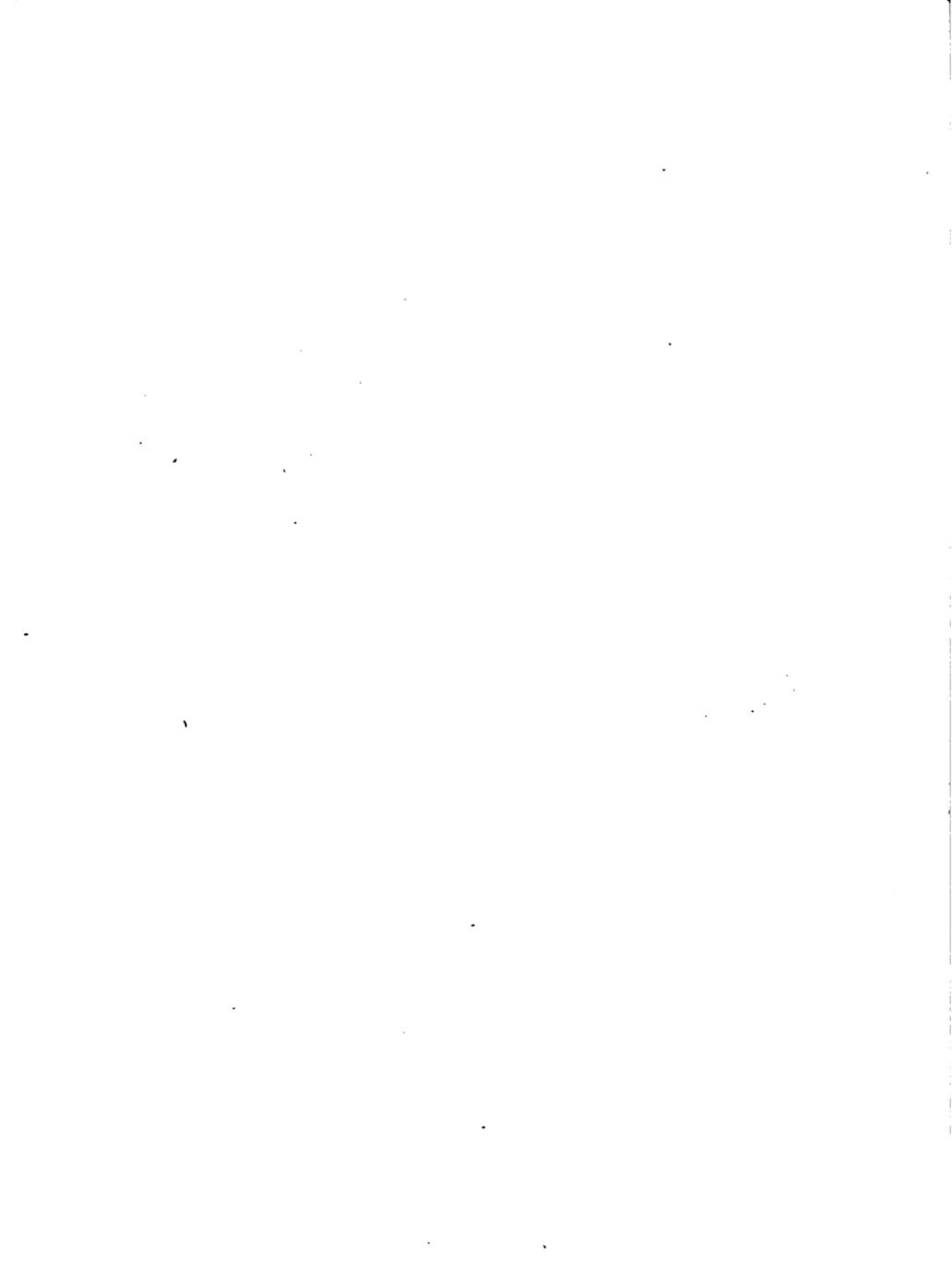

objects to be feared, the ptarmigan are now easily disturbed, and rising at greater distances circle round the highest peaks and rocks, not pitching as before so soon as they pass out of sight over the sky-line, but wheeling round and frequently continuing their flight until they have put the whole length of the beat which has already been traversed between them and their pursuer. There is nothing so provoking as to see covey after covey of these birds rising out of shot, and going exactly where you don't want them to go. It may involve a very long climb to get to the summit of another of these stony peaks, and if you have already been there, and are working your way in a certain line with a view to traverse a chosen space of likely ground before the sun is low, it is a trial to the best of tempers to see bird after bird turning round out of shot and going exactly in the opposite direction.

To guard against this it is generally a good plan to station a gillie on each separate stony peak where you have found birds in the morning, that when they return they may be at once dislodged on the chance of their once more coming to the ground you propose to traverse. These men can act as markers, and are often most useful in indicating by signs the direction taken by birds which have turned over the sky-line.

No system of driving ptarmigan over one or more guns has been successfully practised so far as we are aware—indeed, their habits of flight would preclude the possibility of achieving any great success in this manner. Wheeling as they do in large half circles around the hills, and frequently crossing deep valleys from one eminence to another, they could not, like grouse, be guided to any given spot by lines of beaters or flags. The best, and indeed the only, way to approach them is by walking. A steady pointer or setter is always a valuable auxiliary, but a dog must be extremely well broken and staunch at the point to stand the temptation of seeing birds running about close under his nose without attempting to run in upon them. The dog should never be allowed to range wide, and unless birds are very scarce one dog at a time will be found better than more.

In traversing the ground it is best to walk as much as possible on one level—that is, to work your way round the hills rather than up and down them.

A ptarmigan rising above usually offers a difficult shot, skimming out of sight very rapidly. If you walk downhill there is the climbing to be done each time to regain the upper ground, which must not be neglected. A walk along the side of a likely hill can be repeated at different levels as occasion may require, and the shots thus obtained with the least exertion will usually be the most satisfactory. Ptarmigan rising on a side hill commence their flight away from it, and turn parallel with the curve of the hill after traversing a short distance ; affording easy shots before, or at the moment of changing, their direction. In August and September, when the weather is fine, the whole covey usually rise at the same moment and seldom scatter.

Their flight has been compared to that of pigeons, but it reminds one rather of the sailing progression of black game, alternating with the rapid wing-stroke of the grouse. Owing to the peculiar way in which ptarmigan always keep together, their heads all pointing in the same direction, whether in rising from the ground or in turning in the air, they afford strong temptation to the youthful sportsman to indulge in a family shot. To fire a small bore without any special aim into the midst of a number of birds is always reprehensible and unsportsmanlike; but in the case of ptarmigan a skilled shot, when allowing the birds to reach a fair distance from the gun before firing, will frequently be able to secure two, or even three, at a shot without the risk of wounding any other bird. At the moment of turning to direct their flight parallel with the hillside a covey very frequently presents the appearance of three or four distinct groups or pairs of birds, and if the individuals of any one of these groups have their necks and heads close together, there is an instant when they can be safely killed at the same shot, if the angle at which they fly happens to bring them all in line with the gun.

A marker placed on an eminence should keep a sharp

look-out for any towering bird ; it frequently happens that such birds will fall over some deep ravine, and these would be inevitably lost if not carefully observed when falling. A bird towering at a distance may involve a very considerable amount of travelling and climbing. It is by no means unusual to see from the ridge of a high precipice the little white spot indicating a dead bird at the bottom, and to know that a mile or two of hard walking is required to save the quarry from the crows.

The best hills in Scotland for ptarmigan are to be found in



Ptarmigan.

Rossshire, around Loch Maree, and in the Auchnashellach forest; Sutherland, Caithness, and parts of Perthshire also afford good sport on their highest peaks and ridges.

The pursuit of these birds in winter is attended with much uncertainty and often with considerable risk.

It is no small disappointment after a long climb at an early hour in the morning to find the tops capped with heavy mist, and to be obliged to abandon the attempt to obtain sport. But it is far worse to be benighted in a fog or caught in a blinding snowstorm before regaining safe ground. One false step in such a case may land the most careful and active man at the

bottom of some ledge of rocks, with his gun and bones alike broken and past repair. Those who have come across a little American 'skit' which describes the tragic end of 'the beautiful Annabel Lee' will remember that her 'works' were badly injured under somewhat parallel circumstances.

The best bags of ptarmigan known to the writer were made in 1866 by the Hon. Geoffrey Hill at Auchnashellach.

In October 1865 two guns killed sixty ptarmigan in one day, but in 1866 the following extraordinary sport is recorded :—

1866		No. killed	Guns
August	20 . . .	92	3
„	25 . . .	122	1 (Hon. G. R. C. Hill)
„	29 . . .	82	1 do.
September	17 . . .	60	1 do.

The writer once killed forty-seven after luncheon on the summit of Ben Hope, in Sutherland, and had he reached the ground in the morning, the number of birds found would certainly have enabled him to make a very much larger bag.

W.

CHAPTER II.

BLACK GAME.

AMONG the numerous game birds of Great Britain few can compare in beauty of form and plumage with the black-cock. Black game are to be found from the north of Sutherlandshire, all through the Highlands, to the south of Scotland, in the north and south of England, Hebrides, and Orkneys. Though many attempts have been made to introduce black-cock into the distressful country across the Channel (Ireland), both by sending eggs and young birds, the endeavour has always failed, though there are plenty in Cantyre, Mull of Galloway, quite within sight of it ; they abound also in Germany, Switzerland, and Norway.

We may begin with some comments on the habits of black game. They will be found at the end of December and through January in packs, composed sometimes of all cocks, at others of all hens, but more often mixed of both sexes. A little later, depending to a great extent on the weather, they will be seen congregating on hillsides in bare spots,¹ and in March and April the cocks commence fighting. They usually select a smooth

¹ About forty years ago—I think it was in 1846—in the month of April, I saw a curious sight very early one morning—17 or 18 black-cock holding a parliament. They had got on to a bare dusty spot in the heather some five or six yards in length and breadth. One old fellow stood up in the middle making a gurgling sound ; the rest kept up a sort of dance round him, all going round the same way, flapping their wings, and making the same sort of noise. It was about six o'clock A.M., and I was on horseback, and passed within twenty yards quietly at a foot's pace. They took no notice of me, and did not leave off their occupation.—ED.

bit of meadow land, a sort of natural platform of turf, and at early morning you will see them strutting about, spreading their tails, making a kind of drumming noise, showing themselves off to the best advantage to the hens, who sit around looking on at the fights. We have watched these combats, and they are quite worth getting up early to see. The birds are so intent on their own affairs that they will not appear to notice a man though he may go pretty close to them. These fights generally begin by one or more veterans flying down on to the platform, where they are speedily joined by others, and they fight most viciously, until the weaker birds are driven off and only one or two left masters of the field. The younger birds keep at a respectful distance, while their seniors are engaged, but the combats cease as the day advances, when the birds fly on to the hill again. Soon after this season the cocks with five or six hens each will be seen keeping company together, the hens now remaining much under covert in long grass and ferns. And so they live and love till the nesting time begins, about the latter end of May. They select for their nest a rush or bent bush in preference to heather. They generally lay from five to eight eggs; the time of incubation is twenty-seven days. The young birds are very tender and difficult to rear; a wet summer kills many, and as the mothers are not careful, and get no assistance whatever from the males in the rearing of their families, there is great loss amongst the broods. Many attempts have been made to rear black game under a hen, but they have seldom succeeded.

Black game moult at the end of July, and it is not till October that they get into good plumage. When moulting, that is to say during August, the cocks lose their tails, their bumptious demeanour disappears, and they keep more out of sight, in bracken and bushes; they lie very close, and afford very easy shooting, for sport it cannot be called. When their tails are grown again they take to more open ground, and later in the season sit on thorn trees, alder, birch, or on stone walls. They prefer an undulating country with rough herbage,

a mixture of heather and grass. Cornfields near at hand will do much to ensure a good stock, though you will find large packs far away from corn, that do not go to the stubbles at all. Their food consists of seed of rushes, mountain ash berries, shoots of hazel and Scotch fir. They roost on the ground, and are easily netted in the following fashion. The poachers watch the birds coming to roost after their evening meal into sheltered 'cleuches' or gulleys, and after a few evenings' observation they know pretty well the whereabouts of the game. The men then set to work with their nets, most of which are made of silk, and can therefore be stowed away in a small compass, and put out of sight speedily. In one night many a brood, and old birds too, are taken. The best method of preventing this sort of destruction is to fix stakes about a yard or a yard and a half in length into the ground, with a long nail driven into them at the top, and turned down at right angles. These should be placed wherever it is known that black game are accustomed to roost. This is the best plan also on an open moor for preventing grouse-netting. The border counties, Cumberland especially, the neighbourhood of Hawick, &c., are about the worst places for this species of poaching.

Black game, like many other game birds, are becoming less numerous than they were twenty-five years ago. Amongst the many theories advanced to account for this, there is, first, the very wet seasons of late years at the period the young birds are brought out. Secondly, the deep open drains now made by hill farmers, into which the young birds fall and are drowned; even in a dry season young birds which tumble into one of these cannot get out again, and so die of starvation. Thirdly, the damage done by rooks to nests and young; this last being very much greater than many would believe. It has always appeared curious to us that where pheasants, capercaillie, black game and grouse are within easy access of each other, and are often seen near together, so very few crosses have been shot. We have only known of three or four, as

follows : a beautiful hybrid between a black-cock and grouse at Scone Palace, killed near Dunkeld ; one, we cannot remember where, between a black-cock and capercaillie ; and one between pheasant and black game which the Earl of Home has at Douglas Castle. At Moncrieffe House, N.B., we shot a very curious cross between a pheasant and barn-yard cock, certainly not to the benefit in the appearance of the former. The head and body were all pheasant, the tail precisely resembled the domestic poultry. They used to take to the trees and would not come out of them, not being able to fly any distance.

Black game ought not to be shot, in our opinion, till September 1st or 15th, and should be open till the end of December. Few sportsmen would object to this, though perhaps some shooters (there is a broad distinction), not very good at hitting them when driven, might prefer kicking them up under a pointer's nose in their half moulting condition. On a dull misty day they are easily got at ; they will sit on thorn bushes and alders, and let the shooter pick them off one by one. We remember once on such a day taking a noble sportsman who was very keen to shoot a black-cock up to some black game sitting on a thorn hedge. When we got within about twenty-five yards he fired his first barrel (after taking a very deliberate aim) at an old grey hen. She took no notice, only shaking her feathers a little, and hopping a short distance further on. The same result with the second barrel. He loaded again, and fired. This time the old hen turned round and looked to see where the noise and unpleasant tickling sensation came from, and grew uneasy ; the next attempt made her fly on to where her companions were sitting, and our friend then gave up his weapon to us in despair. Black game grow very stupid also when on stubbles ; they will let a man fire at them, and if they do not see him, will fly round the field and settle again, or pitch on a wall quite near to him. Grouse will do the same thing. There is not much 'sport' in such shooting as this, but when out alone and wanting to make a bag it is a sure and quick way

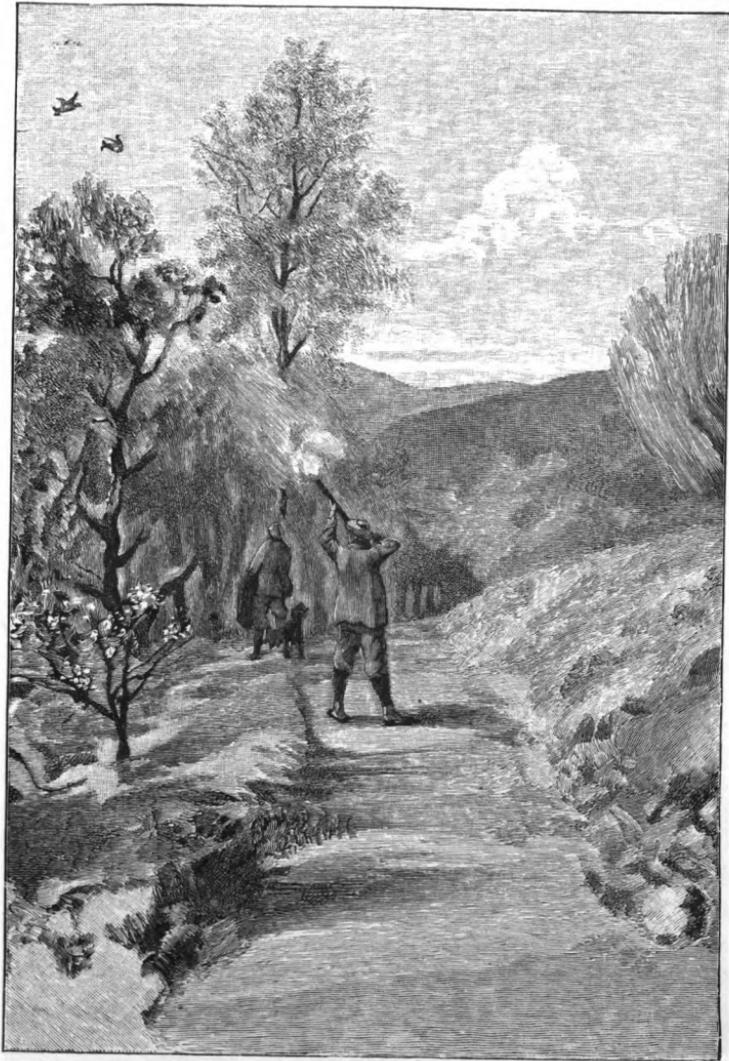

'BLACKCOCK OVER

to do so. It may be called 'poaching'; all we can say is, there would be many more gentlemen poachers if they could obtain such chances, and could not get game in any other way.

Probably the best black-game shooting in Scotland is in Dumfriesshire and the neighbouring counties, though here as elsewhere they are, like other game, diminishing year by year. We can remember some good days' driving at Drumlanrig Castle, not so very long ago; about two hundred black game and one hundred odd grouse were bagged in one day—the estimate is rather under the mark—and this with only one muzzle-loader each. At a black-cock drive a few years ago, we remember seeing, and indeed trying, a very artful way of attracting the birds when guns were stationed at a wall. A veteran sportsman took a grey hen he had killed, cut a piece of strong heather like a forked stick, put the hen's head and neck in the fork, and set it upon the wall near him. For a short time it did certainly attract some hen birds; but the example of the author of the ruse was speedily followed by the other guns, and soon ceased to be profitable. If a man were by himself, a few stuffed birds put on a wall might help him in making a bag. 'Poaching again!' we hear censors saying, and no doubt there is something in the charge; still, if in fishing it is allowable to put on a lure to catch or attract your fish, why may not artifices be employed in shooting to bag your bird?

Before finishing this subject we will make a few remarks on black-game driving, which, though not so exciting as grouse driving, is a great addition and gives variety to a day's sport. It is quite a different art from grouse driving, for a man may be exceptionally successful with grouse and fail altogether to circumvent black game. Grouse as a rule fly *down* wind, black-cock *up*. The latter usually take this direction, as in a strong down wind their long heavy tails are much in their way, so they prefer beating up against a heavy head wind. As an instance of their practical inability, at any rate great disinclination, to turn down wind, we have seen—when it was blowing hard—black game, cocks especially, hang about the wall where the

guns were placed, and submit to be shot sooner than turn and go away down wind. In shooting both grouse and black game in a gale up wind you must 'draw a bead' on your birds or you will surely miss them—especially if in the previous drives you have been sending the birds down wind. Before beginning to drive black game, the natural flight of the birds should be found out by the head keeper. (N.B.—They will not drive well till the corn is all cut.) He should start the birds several times very quietly, and he will soon be able to find out what he requires to know ; of course the position of stubbles must be studied, as they alter every year by the rotation of crops. If it can be avoided, it is never well to attempt to drive on a windy, blustering, wild day, as such weather generally precludes success ; it scatters your birds, and they do not collect again properly or drive as well for some time after. A dull misty rain with little wind is the best sort of day. The system now adopted for grouse driving, of having boxes for the guns, does not answer so well for black game, for you must shift your places according to circumstances, and as black game usually come in a bunch, the guns must be placed closer together. Many old sportsmen have a longing, with which we can fully sympathise, for the old days when shooters were placed for grouse driving where it was likely, according to wind, that the birds would go, and sat on their game-bag with sometimes nothing but a rush bush or a slight inequality of the ground in front of them. If they sat still, and did not bob their heads about as if they were trying to hide them, as ostriches do, the birds would come straight in their direction. Talking of trying to hide the head puts us in mind of a most amusing thing we have seen more than once in stalking birds under a low wall. A tallish man begins by going on his hands and knees, and crawls along never thinking of the height of the wall, head well down, forgetting that the other end is well up, and showing above the dyke ; on he goes, and at length, when he thinks he is at the right place, blood well to his head and generally demoralised, he peers cautiously up, looks over

the wall, and lo ! all the birds are gone. Then the remark is always the same : 'What could have put them up ? I am sure they never saw *me!*' Many a red-deer's life has been saved by this forgetfulness on the part of the stalker. One thing should ever be remembered in driving black-cock : if the birds are seen sitting on a hillside the guns should always be placed at a lower elevation, as when started they invariably fly away at a lower level, scarcely ever going up-hill. Packs of black game, after having been much driven and bullied (although such a result ought to be avoided if there be a large extent of ground), will take a higher flight, and at last will not come in to the guns at all. Nothing is so good as to let them rest for half an hour or so, if the same birds are being 'used,' for if driven too quickly and often they can be as obstinate as donkeys.

Attempts should never be made to drive black game against their natural flight. Flankers are useful (though not of so much importance as in grouse driving) if kept out of sight till exactly the right moment ; this, again, is different from grouse driving, for you may turn a single bird, or even a large pack of the grouse, but seldom black game. There is no greater mistake in driving either one or the other than to allow the drivers to run and shout and throw their caps and sticks as is too often done at birds trying to break back. Anything like riot is utter destruction to this sport ; everything should be done as quietly as possible. Birds are more easily induced to turn if the drivers lie down in the heather, permit the game to come pretty close to them, and then rise up suddenly, but never shouting. It is far better to let the birds go quietly back, because then they will probably not go out of the ground or day's beat. If they are much frightened and scared, they will rise high and go clean away for the day. The head driver should be always on a flank, where (if he wishes it) he can be seen ; he and his men should work like a machine, signals all coming from him, given with a red flag on a long staff. Sometimes a large lot of birds (grouse especially) seem determined to be unruly and not to come on to the guns, and make for

some part of the line where there are no drivers visible. On a signal from the head man five or six drivers will be seen to rise, and the pack will swerve round and try some other place, probably on the other flank ; the same thing will happen two or three times till the whole pack, led by a few plucky old cocks, will come on recklessly to the boxes. If well done, it is a very pretty sight. We prefer red flags to white ones for drivers ; they do not scare the birds so much, though a white flag here and there about the centre is a good mark for the guidance of the flanks.

There is certainly not the excitement in black-game driving that there is in grouse, for this reason : in the former the birds are often in sight before they are started, and the drive is short and soon over, whereas in the latter there is a glorious uncertainty after a man enters his box whether things will go right or not. Sometimes after a long wait the heads of the drivers will appear on the sky-line, and it will be seen that all has gone wrong ; at other times birds will begin to come very soon, and there will be regular shooting all the time. Nothing is so fatal in a long drive as birds, both grouse and black game, pitching in view of the boxes. A most maddening thing, which we have seen many a time, is when, some large lots of birds having collected within a hundred yards or so in front of the boxes, a solitary bird, perhaps a grey hen, flies towards the guns. The elder sportsmen are saying in smothered tones, 'Don't shoot, don't shoot!' but some wretched novice does, and up get the whole lot and go clean back. We have seen, what is even worse, a sportsman, not so very young either, fire at a hare. On these occasions the culprit should be ordered home. There is another occasion in which condign punishment is required, that is when a shooter follows his bird round with his gun at his shoulder. On these occasions the position of the other sportsmen is apt to be utterly ignored by the offender. There should be no false delicacy as to warning the offender of his error in time to prevent an accident. We have often been in the field with old as well as young gunners who seem to

forget that there are other people out shooting besides themselves, and rake a whole line of sportsmen in their anxiety to keep their eyes on their bird. Those who have been accustomed to driving game of all sorts will enter into our feelings on the subject of 'following round.'

Black game are found in the New Forest, and in other parts of England; but are diminishing, although they have been rigidly preserved for some years, and Scotch birds have been turned out for a cross. Only a few years ago black game were found in almost every county in England, even in Middlesex.

C. L. K.

CAPERCAILZIE.

Some hundred years ago these majestic birds were plentiful in the north of Scotland, but from different causes they have since become gradually extinct. The falling off has been owing partly to the increase in cultivation, but chiefly to the destructive hand of man, who by slow degrees has extirpated so many of our *feræ nature*. For besides capercaillie and bustard, it is sad to find that the wholesale destruction includes eagles, hawks of every description, from the noble peregrine to the poor innocent little merlin and kestrel; and the reason of this slaughter may well be asked. The answer generally is that the birds in question do so much damage to game. Those who say this forget the good that is done by these 'scavengers' of the mountains as they have been called. But this is apart from our subject.

Capercaillie are plentiful in Norway, Russia, and Germany; they entirely disappeared from Scotland about the end of the last century, and for a long time were forgotten. In 1836, the second Marquess of Breadalbane determined to try and reintroduce them at Taymouth Castle in Perthshire, and sent his keeper, a man named Guthrie, to Norway, in the hope of procuring some birds. This Guthrie accomplished, and in the early autumn of 1836 he brought home some thirty or forty specimens, and turned them down at Taymouth. The result was a great

success. After a few years they began to stray, and appeared in many places in the north of Scotland, in Forfarshire, in the Rannoch country, in the woods at Dunkeld, Dupplin Castle, Scone Palace, and Logiealmond, all in Perthshire. They increased very rapidly, and in three or four years became numerous in all the places mentioned. They are not easily reared under hens ; indeed, such attempts at breeding have, we believe, rarely succeeded. They seem to select for themselves the places they wish to inhabit : capercaillie have nowhere thriven unless they came of their own accord. We have sent eggs and young birds to Inverness-shire, Lanarkshire, Dumfriesshire, Cumberland, but in all instances the attempt to introduce them has ended in failure.

Capercaillie and black game are both classed as of the grouse family, we could never understand why, as there is nothing in common between them. Their plumage varies, to begin with ; they do not frequent the same kind of ground, their food is different, they do not pair as grouse do ; they can exist, which grouse cannot, without heather. They do not collect together in large packs ; indeed, their nature and habits are quite distinct. Capercaillie roost on trees, cocks and hens very often together, and sometimes several on the same tree. They can be poached in the same way as pheasants at night, but as they roost on Scotch fir-trees they are not easily seen. When moulting and unable to fly well they roost on the ground. The cocks begin to collect their harems at the end of March, and then they fight very savagely ; they make a great noise, striking with their wings, beaks, and claws, both the latter being most formidable weapons. They feed chiefly on pine-tops and acorns. Hens begin to lay at the beginning of May, the period of incubation being about three weeks ; they make their nests on the ground, and lay from seven to eleven eggs. The young birds are very difficult to rear, and in a wet breeding season many die. We remember a very pretty sight at a shooting lodge, Rohallion, near Dunkeld, some years ago. There were in the garden in

front of the house under hens five different kinds of game all hatched out, namely, capercaillie, black game, grouse, pheasants, partridges, apparently in good condition. But the capercaillie were by far the most delicate looking, and eventually died before half grown; most of the black game also died; grouse throve well and were turned on to the moor.

The cock capercaillie is very wary, the hen much the contrary. The best way, indeed the only way, to shoot the old cocks is to go out on purpose, placing the guns as quietly as possible in open places in the old fir woods they frequent, and where their natural flight would take them. The cocks when driven a few times get very wary; they will soar above the woods for a long while, higher than almost any other game bird, and remain long before they come in again. The first capercaillie we ever saw were at Dupplin about the year 1855. Two cocks appeared in an out covert, and seemed not the least alarmed at the shooting going on near them; they were sitting on a birch tree, and let us get quite close to them. They were then strictly preserved for some years and not shot. The next we saw were in the following year, on the shores of Loch Rannoch, two or three cocks with some black game. Soon after this they became plentiful in many places in the North of Scotland, and were regularly shot.

We have known as many as thirty and more killed in a day at Dupplin when the woods were being driven for them and roe-deer in winter. In August and September, before the corn is cut, the coverts in the vicinity of cornfields, though well stocked with capercaillie, may be beaten and scarcely a bird will be seen. We remember a few years ago, when H.R.H. the Prince of Wales was at Dupplin, that the woods were driven with every expectation of sport, and to our great surprise nothing but a few hens were seen, the cocks being all in the standing corn. Towards evening, however, a few cocks were killed. It should be remembered, in shooting these birds, that their only really vulnerable place is in the head and neck; farther back shots strike ineffectively, as their breast is armour.

Should one be winged, the sportsman must be very cautious how he approaches or tries to take hold of the bird, for he can make an ugly wound with his beak, and knows how to use it, as we have seen on several occasions. Capercaillie will run at the shooter, making a hissing noise, looking splendid in their rage. They are noble birds to bring down in full flight, but big as they are we have known more than one missed in a drive, and in the open. While covert-shooting in winter at Dupplin some years ago, on a wet day, after an equally soft night, we have seen the old cock birds lie so close that if not observed they would let a man pass them; the reason of this was their inability to rise into the air from the ground, their pinion feathers, when wet, not being of sufficient power to lift their huge bodies. If started in this condition they will attempt to fly, but it ends in their flapping along the top of the heather, and they could be knocked on the head with a stick. The hens fly well and quickly; we have seen them killed in a day's covert-shooting by a very quick shot who declared that he mistook them for woodcock. The cock bird has an awkward way of rising off the ground, and does not get quickly on wing at any time; even when starting to fly from a tree, they throw themselves from it, as it were, with a forward, swooping motion, and drop a foot or more before their wings seem to acquire the power to support them in their flight. The only other bird we have seen with the same peculiarity is the cormorant, if started from a tree or rock.

An idea is prevalent that capercaillie are injurious to pheasants and black game, but in this we cannot agree. They are seldom seen together, and from their habits do not associate, though they may occasionally meet in a stubble field at the edge of a big pine wood. Cock capercaillie will sometimes amuse themselves by upsetting and pulling to pieces the stooks, apparently out of pure mischief. Very little can be said as to the value of the capercaillie for the table. The only way to make them tolerably worth eating is to turn out the contents of their crops, which are usually full of pine-tops, the instant they are killed.

C. L. K.



‘ The shot. ’

CHAPTER III.

DEER STALKING.

THOUGH it is not known at what date red deer were introduced into Scotland, we may safely assert that when William Rufus was hunting deer in the New Forest many a ‘red’ Sandy and Donald were similarly occupied in the Highlands.

In those days, when there were no arms of precision, when bows and arrows, swords and spears, were the only weapons, and the odds were all in favour of the wild animal, there would be little compunction as to the means employed for his capture. If our ancestors wanted venison they got it as best they could, and if they held a great hunt they were not very particular as to the method, provided the result was satisfactory.

Probably in these early days stalking was little practised. Driving, coursing with men and dogs, mobbing deer among the rocks and killing them in the lochs, were the blunt methods employed. Even pitfalls and snares, and an arrangement of sharp spikes in the bathing pools, were often used, and very many deer met their death in the deep snow, falling an easy

prey to their hungry enemies. Wolves, too, helped to thin their numbers, for these beasts seem to have been pretty numerous in comparatively modern times, the last on record having been killed by Macqueen, who died as late as 1797.

But though many deer were ruthlessly slaughtered, they were strictly preserved by law in certain places. There were many forests, and many of these were grants, as such, from the Crown, originally considered as *inter regalia*.

It is worth noting that our ancestors were good judges of ground, for most of the places then made into forest are forest at the present day. Among others we may mention the great forests of Athole, Mar, Invercauld, Blackmount, and several in Sutherland, indeed, a large proportion of the high ground of this county was forest, notably the Reay country, Ben Hope, Fionaven, Arkle, Druimchatt, Diniemeanach, Ben Armin, &c. In Gordon's 'Earldom of Sutherland,' dated 1639, it is said, 'There are three principal forests in Sutherland, and divers other such particular chases and hunting places full of woods and deer.' It then gives many names, all of which are at this day favourite haunts of deer. It mentions that in Arkle the deer have forked tails. This breed is, we fear, extinct; at any rate, their tails are.

The Blackbook of Taymouth mentions a tack (lease) by Colyne Campbell to Archibald Campbell of Glen Orghy, of the land and the forest of Bendoran with the pertinents for nineteen years from 1567, it being provided that said A. Campbell shall have a sufficient man under him for keeping said forest, and shall hold and nourish as many deer as it may reasonably sustain, no 'fault being in the forestership.'

In 1622 King James was much interested in a white hind, and wrote himself to order its capture, commanding that it might be sent to him from the forest of Corriechiba. There were other forests more or less strictly preserved, indeed, deer roamed over most of the high ground and through the great woods that then clothed the mountain sides; and occasionally the deer were gathered together and a great drive took place.

We have many records of great deer drives, or 'Tainchel' as they were called. One on a very grand scale, which lasted for three days, was given in Athol to King James V. and Queen Mary. Another in Athol was given to Queen Mary in 1563, when 2,000 Highlanders were employed to drive in the deer of Athol, Badenoch, Mar, and Moray. Another, not a royal hunt, took place in 1618 in Mar, and is thus described by Taylor the water-poet, who was present. The manner of hunting was this :—

Five or six hundred men do rise early in the morning, and they do disperse themselves diverse ways, and seven, eight, or ten miles' compass : they do bring, or chase in, the deer in many herds (two, three, or four hundred in a herd) to such or such a place, as the noblemen shall appoint them ; then, when day is come, the lords and gentlemen of their companies do ride or go to the said places, sometimes wading up to the middles through burns and rivers ; and then, they being come to the place, do lie down on the ground, till those foresaid scouts, which are called the tinkhell, do bring down the deer ; but, as the proverb says of the bad cook so these tinkhell men do lick their own fingers ; for, besides their bows and arrows, which they carry with them, we can hear, now and then, a harquebuss or musket go off, which they do seldom discharge in vain. Then after we had staid there three hours or thereabouts, we might perceive the deer appear on the hills round about us (their heads making a show like a wood), which, being followed close by the tinkhell, are chased down into the valley where we lay ; then all the valley on each side being waylaid with a hundred couple of strong Irish greyhounds, they are all let loose as occasion serves upon the herd of deer, that with dogs, guns, arrows, dirks, and daggers, in the space of two hours fourscore fat deer were slain : which after are disposed of, some one way and some another twenty and thirty miles, and more than enough left for us to make merry with all at our rendezvous.

Another is recorded as taking place in Monar, at the upper end of Glenstrathfarrer, on the borders of Ross-shire and Inverness-shire, in 1655 ; while in 1715 a great gathering of the north was held in Braemar ostensibly for the 'Tainchel,' but in reality to hold converse regarding the great rising of that year.

On the high and rough ground few men ever wandered except in pursuit of wild animals or birds. The cattle and sheep kept to the good grazing lower down, and so, except that they were much killed down on the lower ground in winter, the deer had an easy time of it. As weapons improved, and old muskets came into use, so did the number of stalkers, with or without leave, increase. We must not count all these as poachers, for the deer stalking and the shooting generally having no market value, there was no great object in strict preservation. The hardy fellow who did take the hill had none of the luxuries of modern days ; his was real wild hard work.

He would leave his home on a possible three or four days' expedition, armed with his single musket, his staff, his plaid, in the corner of which he had a small bag of oatmeal which, made into brose at any handy spring, was to be his only food. He would start early for his happy hunting ground, scanning the hills as he went along and carefully looking for tracks and other evidence of deer in the neighbourhood. Judging by these, by the wind, and the season, he selected his night's quarters, when, behind some sheltering rock, wrapped in his plaid, he dreamed of mighty harts. Before dawn he was at his post, some height commanding a good view of the hill. As the early light crept down the hillsides he eagerly scanned each sky-line, each green feeding place, and carefully watched each well-known deer pass, for the deer when travelling, like all other wild animals, generally follow the same line of march, keeping to the hard ground through the mosses and the smoothest track over the hill. He has no glass, but his eyes are good, and he knows how much easier it is to see the deer moving, before they lie down for the day. If he perceives deer feeding, he watches them to their lying ground ; if travelling, he marks their line and makes for a likely pass. Should nothing be in sight, he moves off to some other point or pass that he thinks likely, and perhaps the tracks will tell him when and where the deer have passed. At last he finds them, and, carefully approaching, he gets close

up ; he will not trust the old gun far, but at close range something out of her will probably hit the deer. A bullet, several slugs and some inches of powder were the usual charge. Having looked at the pan to make sure that the flint spark will kindle the powder, he takes a long steady aim. He fires ; the old gun almost jumps from his grasp and nearly knocks him over ; but what matter if the stag be killed ! But his work is not over. He has no pony to carry the deer home, so after gralloching and possibly breakfasting or dining on the liver fried on a flat stone, and dragging it as far as the ground will allow him, he proceeds to cut it up into quarters and starts with one for his home or the nearest friend's house, returning again for the rest. Success for such men as we have sketched was by no means certain, and often after days of cold and wet and bad luck they had to return empty-handed. Sometimes they would watch a pass for days. One of these old stalkers was overheard telling most wonderful stories of what he had seen and heard on a certain hill ; and, being asked afterwards how he could talk such nonsense, his reply was, 'Oh, it's just to keep the lads from the hills.' The place he had described was one of these passes.

The old traditions and even the old names are fast dying out from the Highland hills, but still there are some haunted spots, and generally they are either great deer passes, or handy places for smuggling, or dangerous for children. Many lochs have their kelpies, beautiful animals that attract bairns to touch them. If one is induced to do so he is held fast, then another and another bairn goes to the rescue, but each sticks fast to the others, and at last the kelpie walks off with the lot into the loch. Many lochs have the same tradition, and all of them have soft mossy sides and are dangerous for children to approach.

This accounts for many of the weird stories of all countries, and the superstitions in these cases certainly are useful.

It is generally admitted that in our little island there is no grander sport than deer stalking. Fox hunting alone can

compare with it, if, indeed, comparison can be made between two things which are so essentially dissimilar. Its requirements and its charms are quite peculiar, and, like all other true sport, the greater the difficulties, the more the pursuit is appreciated. The beautiful highland scenery, the invigorating air, and exercise add to the stalker's pleasure, while the hard work is amply rewarded by the many antlered trophies, to say nothing of the fat haunches and good appetite to discuss them. In offering a few remarks on deer stalking, our object is not so much to instruct those already skilled in the art, as to help the young sportsman who wishes to learn how to stalk a deer. The writer has only attempted to describe what he has witnessed, and to give advice derived from his own practical experience. There are many little dodges the stalker must find out for himself; of this he may be certain, that he will never make a good stalker if he is lazy, or a successful one unless he takes the trouble to learn why he fails. First of all, we should like to explain what we mean by sport.

Sport may be defined as the fair, difficult, exciting, perhaps dangerous, pursuit of a wild animal, who has the odds in his favour, whose courage, strength, speed, or cunning are more or less a match for or superior to our own, whose natural instinct engages a considerable amount of our intelligence to overcome it, and whose death, being of service, is justifiable.

The true sportsman, while keen to excel, is not jealous or selfish, does not grudge others their participation in enjoyment, is not careless of the general good for the chance of his own success. Himself hard and tough, scorning luxury on the hill or in the field, he is kind and considerate to man and beast, careful in the pursuit of his sport not to inflict or to risk unnecessary pain; mindful in success to give praise where it is due, and in failure to accept his own full share of blame.

A few words may first be said about the habits of red deer in the Highlands.

Calves are generally dropped in May, the mother hardly ever giving birth to more than one at a time. A tame hind at Duff

House produced twins in the year 1852 or 1853, but this is the only instance in which the writer has ever known such an occurrence. Two calves will often follow a hind, but one may be an adopted child.

Stag and hind calves appear to be about equal in number, but as there are more deaths among young stags, and before their horns are grown they are counted as hinds, the hinds always appear to be largely in excess.

An old hind will generally drop her calf near the same spot every year. In a newly-made forest which held only seven hinds they were observed for several years to calve each almost under the same trees. The spot they usually select is in some rough ground or wood, and the mother conceals her offspring so carefully that it is very hard to find unless by watching her movements and marking the spot, when she returns to suckle it. In a few days the calf begins to follow its mother, and in a very few weeks it will accompany her at any pace, and to any distance. Nothing can be prettier to see than a lot of perhaps twenty or thirty of these little calves at play in early evening just before sunset. First one comes out of the thicket and frisks about, then another joins it, then every calf bounds away to the playground. They run races, jump over every little rock or tiny obstacle, tumbling head over heels in the mosses. But were an eagle to swoop down the corrie, or worse still a man to come in the wind, in an instant every calf is at its mother's side, or, if some watchful old hind give the alarm, one bark from her is enough to stop all their play.

By August most of the calves can follow their mother anywhere. They keep to their mothers for about two years. Hinds begin to breed at two, and continue up to an advanced age. We have shot quite an old hind giving milk without a front tooth in her head.

The stag-calf in his first year has little appearance of horn, merely an excrescence on the skull, on which the horns at one year old and in future years are to grow. While growing, the horn is a soft but gradually hardening porous substance, full of

arteries and veins, and covered with a dark grey skin like velvet. As it hardens the blood solidifies—the course of the arteries forming the beading so much admired in rough horns—the velvet gets lighter in colour, and is finally detached from the horn, leaving it quite white. A few days more, and the stag, by continually rubbing his horns in moss, heather, and against trees, has brought them to that deep brown colour which they afterwards retain, the white tips forming a beautiful contrast with the rich shade of the rest of the horn. Towards the middle of March or April these horns get loose and are knocked off, leaving a flat round surface on which the new horns begin immediately to grow. Unless picked up very soon, these shed horns are rarely found whole. Both hinds and stags are very fond of eating them, as they are of any bones they may find. Whenever a dead deer is left on the hill, birds of prey and insects will quickly pick the bones clean, leaving them for the deer to finish, which they soon do, gnawing them, and trampling the ground up round them, and as they get broken up, even carrying the fragments for considerable distances.

It is often stated that each year adds two points or tines to a head. This is a mistake; some heads never have more than four points (Caber Slat, or rod-heads), while others may have eight or ten at two or three years of age, and this number may or may not increase with every year till the stag has reached his prime. The lowest point is termed the 'brow' antler, the next is the 'bay,' then the 'tray'; these, with three on each top, constitute a full head, and if the three on each top form cups the head is a royal one. This number of points on the tops is occasionally exceeded, and heads of eighteen and even twenty points have been killed in this country; while in Germany and Austria, where the feeding is far better, the same species of deer produces heads of forty and even more points, all shed and grown again as with our own stags every season.

In order to show good heads deer must have good feeding in the spring; if their condition be poor in March and April,

so likewise will their horns be. Wounds also, especially in the head and neck, affect their growth, and sometimes entirely alter the shape of one or both horns. Barring accidents, the character of the head will remain the same, though the weight and beam varies with a good or bad season. The character of heads varies in different forests; there are usually most points where there is most wood or good winter feeding and shelter.

In hill deer, heads go on improving up to the age of twelve or fifteen years; on low ground, with more forcing food, they come to maturity sooner. The heads then remain about the same for some years, after which they gradually lose beam, get smoother from the blood-vessels being no longer so vigorous, the points taper more and are shorter, till finally the head dwindles to half its former size.

The late Duke of Athole preserved and mounted the shed horns of certain stags for several consecutive years. He found they all began to deteriorate at twelve or thirteen. The deer had been kept in a rough park and had rather better feeding than their wilder brethren on the hill, and perhaps arrived at maturity somewhat earlier.

This process of horn-growing naturally takes a great deal out of a deer and much retards his condition. Directly the horn is hard, however, he improves rapidly, and for a few weeks must put on many pounds a day.

Whilst the horns are soft they are extremely sensitive, and the deer are most careful of them. It is sometimes amusing to watch the airs of a small stag whose horns happen to have hardened early. He knows that for the moment he can bully his betters, and makes the most of his opportunity. We have several times seen a small stag make a big fellow with soft horns get up, when the little one would lie in the vacated bed; as soon as the old stag once more got comfortably settled the little one would turn him out again. This is not the only way in which we have seen young stags take advantage of the situation. To mention another instance, though of a different character. Some stags were moving along a steep path

up a soft mossy bank. One very fat heavy animal was labouring hard through the moss when a little fellow, not half his weight, saw his opportunity; turned sharp round, caught the big one full in the flank, and sent him rolling down the brae; then away he went best pace up the hill, evidently chuckling over the success of his little game. It is to be hoped that short memories are the rule among deer or he must have been made to suffer for it. Sometimes stags have no horns; these are called Humble stags. If naturally so, and otherwise perfect, they will thrash any other stags of their own or even considerably greater weight. We have known several of them undisputed masters of large herds. If artificially denuded, or from wounds, they lead a quiet bachelor sort of life; they become exceedingly cunning, are fattest when other stags have lost their condition, and often live to a great age.

Sometimes they have but one horn, and occasionally deformed horns. We have also seen cases of three-horned stags, one in the Guisachan forest; another in the woods about Belfort had three horns, one of which was deformed. This was a notable stag on account of his enormous weight; he was killed by Colonel the Hon. Alastair Fraser in 1876. He had been hit in the head by a pea-rifle bullet five years before. When killed one horn had six good points, the other was a long spike with four points, and beside this he had a third horn hanging down on his cheek about a foot long, and always covered with velvet. His weight, quite clean, was 30 st. 2 lbs., and he was probably the heaviest truly Highland stag killed for many years in the North. His haunches weighed 73 and 75 lbs.

A sportsman going to the forest about the first or second week in August—the date generally depending upon whether the deer are in a fair or backward condition—usually finds the animals high up on the hills, and in large herds, stags and hinds more or less together, and—where so many eyes are watching—difficult to approach, more especially as only some three or four clean heads can be seen, and these of course are the object of the stalk. The heat and the midges have put them off the

low ground and seem to keep them wide-awake all day long. A few of the old stags, however, and some other deer will stick

to the woods in spite of heat and flies, and lie in cool dark holes, hiding from 'Morn till. midgey eve,' and the quiet wood-stalking after these is very exciting, though not nearly so scientific as the hill stalk.

While the deer are in large herds on the tops, for

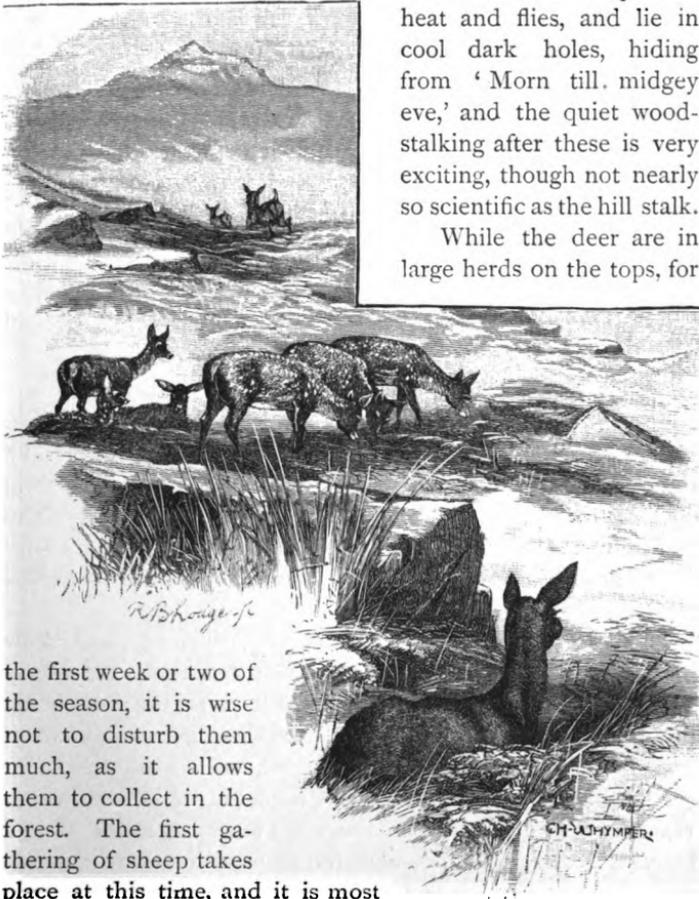

the first week or two of the season, it is wise not to disturb them much, as it allows them to collect in the forest. The first gathering of sheep takes place at this time, and it is most important that the deer should find a quiet refuge the first time in the season that they are moved. Then on their next disturbance they will probably run for shelter to the place where

Calves and Hind.

experience has taught them to feel safe. A few quiet stalks and single shots do no harm to the ground, get rid of London humours, and prepare the bellows for harder work later on. Even without a shot nothing could be more enjoyable than climbing the great hills in the early morning, watching the quiet herds taking up their position for the day just between the winds; the little ones playing, the older ones indulging in the more sober amusements of a mud bath, one or two old hinds alone appearing to be on sentry. Then as the sportsman sits and observes their impracticable position, always hoping for a change, noting each good head and every impossible mode of approach, he enjoys the hot sun overhead, and perhaps watches a pair of old eagles soaring over their nest in the neighbouring corrie, or a raven whose hoarse 'cr-cr-' seems to foretell certain blood. Should the eagles approach too near, the calves will close up to their mothers and the whole herd will move. Eagles often take sickly calves, and have been known to attack a full grown stag. They usually swoop down upon him in rough and rocky ground, lighting on his shoulder and flapping their wings over his head. The poor stag, terrified and blinded, rushes away, falls over a precipice, and is killed, thus forming many a dainty meal for his terrible enemy.

As the summer goes on the herds get broken up; stags draw away by themselves; they do not seem to care for the fidgety hinds and frolicsome little calves. These prefer the rich feeding of the valleys, while the stags like the stony ground and sweet grass of the high tops, for as they grow fat, like other animals, they require a smaller quantity of food, but of better quality. When September comes in the stags will often move off in a body on a change of wind, leave the forest without any apparent cause for alarm, and take a walk for a week or more, sometimes each one by himself, sometimes in couples, occasionally thirty or forty together. We have known a herd of some fifty stags travel over fifty miles in as many hours.

We found this herd one morning, and from the way they were

lying on the hill at once saw they were strangers. Among them was a stag with a peculiar head ; one horn grew in the usual way, the other was bent straight down alongside his face, so that he could only feed on the tussocks of grass, and then only by holding his head on one side. We got close to him and shot him ; he was a fairly fat stag of about 15 stone with eight points. This was on a Wednesday ; on the previous Monday this stag was seen in a forest about fifty miles distant. The wind changed to the east, the herd in which he was began to move, never settled till they left the forest, and were watched till they disappeared over the march.

These stags out for a walk do not remain long in one place. When first heard of, no time should be lost in going to look for them, as probably they will have gone before the next morning. Many great expectations have been disappointed by their sudden departure. What prompts them to these excursions it is impossible to say, unless they are holding councils as to where they will go when the rutting season comes on. Stags will often travel great distances for *health*—actually for sea-bathing. There are several places along the coast, and one spot in particular, in Aberdeenshire, forty miles from the nearest deer-forest, where stags are annually killed in winter and spring. These are always wretchedly poor and out of condition ; but if the men do not turn out at once and secure them within two or three days of their arrival, they are off again whence they came. They come to bathe in the sea—as is seen by their tracks—bathe two or three nights, and go home again. Who the doctor is that recommended the treatment, and what the cure, we cannot say, but certainly one may look upon it as a strong natural argument in favour of sea-bathing.¹

When the weather gets unsettled and colder, which it usually does in September, the large herds break up. The deer spread more generally over the ground ; the stags keep more sepa-

¹ Sir Frederick Milbank states that in Lewis and Harris he has on several occasions seen deer visit the seashore, and eat the seaweed exposed by the ebb tide.

rate from the hinds, a few watchful old ladies, however, often remaining with the herd.

The best stags generally keep together in the large herds, but when the herds break up they usually join the same lots that they were in before.

In sheep-ground, or where there are few deer, a big stag is seldom found quite alone ; he has a small one as his slave. This little fellow has to do all the dirty work—in fact, fag for his master. The old gentleman lies snug in a hole out of the wind, or covered from the flies, the slave has to lie out on the hillock where he can see ; and if, trusting to the old fellow being asleep, he looks out for a snug corner for himself, woe betide him if his master catches him. In an instant he rushes out upon his fag and drives him back to his post. Then if there is any doubt as to the safety of the road, the little stag has to go in front, driven on by the horns or fore-feet of the big one. Sometimes an old fellow takes compassion on a youngster. The writer saw a pretty instance of this on the West coast in the season of 1885. Three stags had been moved in a young plantation. The two best jumped the three-feet wire fence ; the third, a two-year-old stag, got frightened and refused. The two waited for him some time, while he walked and ran up and down ; at last, the larger of the two—a good royal—came back to the fence. The little one ran towards him, the royal trotted away ; but no, the little one could not make up his mind to jump. Back came the royal over the fence, went close up to the little fellow, and actually *kissed him* several times. With the glass, not 500 yards off, we could see them rub their noses together. Then the royal led down to the fence and jumped it, but still the little stag would not have it. At last the royal tossed his head in the air ; we could almost hear him say, ‘Well, you are a fool !’ and away he went up the hill to join his other companions.

When out of sight, the little one took courage, got over with a scramble, and followed. We thought this little stag must have been the royal’s fag, but not a bit—at least not for that day.

The fact was, he wished to hide himself and did not want the young fool's company ; so he dropped behind, and when they had topped a hillock he stopped and turned back. But the other two missing him, also turned. He then pretended to go on with them a little farther. At the next hill he did the same, but this time he was quicker, and in an instant dropped down in a patch of bracken. The other two looked back, but, not seeing him anywhere, went on quietly up the hill.

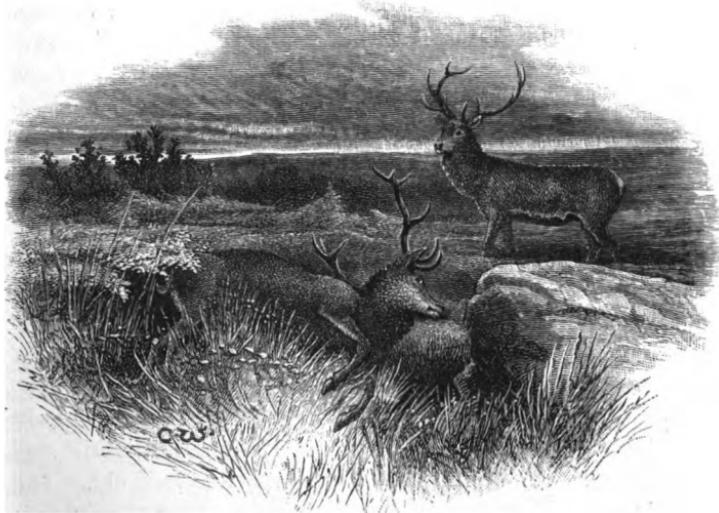

Sympathy.

Instances of almost human fidelity are common among deer. We have several times been witness of them. On one occasion we had wounded a good stag late in the evening ; the herd broke away, leaving him alone. In a few minutes another fine stag, evidently his friend, detached himself from the herd and galloped back to where the first lay wounded in a burn. It got so dark that we could only tell the whereabouts of the wounded beast by seeing the other standing by

his side. We crawled up to about a hundred yards of him, but still could not see the one we had shot. We stood up, expecting he would jump up and make a run for it, but he was too badly hit. Walking on, we at last saw his grey head in the heather, and a bullet finished him. Still the devoted friend kept close by and would not leave the spot. We had not the heart to shoot the poor beast after he had given proof of such wonderful fidelity, and at last had almost to drive him away.

There are three ways of attacking deer—stalking, driving, and coursing. This last is now seldom practised. There are very few forests in which it can be safely attempted, as it alarms the deer and frequently sends numbers off the ground. Formerly there were few deer in the country, the great mosses of the Monalia were suited for that kind of sport, and there coursing did little or no harm. Now the Island of Jura is, or till lately was, the only place distinguished for deer coursing. Though beautiful to witness, it does not repay the injury to the forest. The ordinary way of coursing deer is as follows.

The stag is found, a pair of deerhounds are taken up as near as possible to him and slipped. One or two other pairs of hounds are placed near where it seems likely, from the nature of the ground or the direction of the wind, that the course will pass, and when near they are slipped. The instant that the stag is aware of the presence of the enemy he takes to flight. The pace is tremendous—pursued and pursuers appear to fly over the ground. Soon the deer turns down wind, keeping as best he can the hard ground, the soft mosses being in favour of the dogs. At last, blown and hard pressed, he takes soil—i.e. seeks refuge in some burn or river, where he stands at bay till the men get up and deliver the *coup de grâce*.

This kind of sport has contributed so many splendid subjects to the painter in all countries, that if for no other reason one regrets that modern exigencies should have 'improved it' and the noble deerhound out of the country. Of these latter one sees very few nowadays. The tracker has quite taken

their place, and there is no better tracker than a well-trained collie.

There are several kinds of driving. In the first place, there is driving with a great army of beaters, then the same ground can be driven with a few skilled men. There is also wood-driving, and the quiet moving of deer on the hill.

None of these methods can for an instant compare with regular stalking. Still at times driving is useful and even necessary. There may be a large party of friends to be provided with sport; the wind or the number of deer may make stalking impossible; the deer may have got all crowded into one corner and require to be broken up, or other reasons may render a drive desirable. By far the most sporting way of conducting the business is moving the deer with the help of half a dozen men, with a few guns posted on passes.

A wide corrie and hillside is to be driven. The guns are placed at certain points, after due consideration of the wind and the nature of the ground—some to remain where they were stationed, and some to move according to circumstances. Then the men are sent round, perhaps accompanied by one gun, but this gun must work for the success of the drive, not solely for his own sport. The great art in driving is to show yourself as little as possible. A deer is more afraid of one man he cannot see but suspects than of a regiment in line. Some of the men take post where the deer may break, and one or two more go round to move them. A low whistle, a knock on a stone, or a head shown on the skyline is quite enough to start them. Down they come, spreading over the hillside and scattering in all directions like a swarm of bees. Suddenly they stop, wheel round and examine the cause of alarm. Another tap of a stone, a sight or sound from above, shows the danger to be real, and away they lead for the high passes. The first is guarded, they make for another; again they find a beater stationed. They are now thoroughly alarmed, and gather for a council of war; but they must not be given too much time, for if they settle on a plan they will

stick to it. So a little more noise keeps them moving. The men, meantime, have more or less closed in upon them, but they must not come too near, or they lose command of the situation. An old hind takes the lead, and off they go again, this time for the passes where the guns are placed. These now see them trooping over the hilltops, the great heads magnified against the sky—hearts beat high, and stag fever makes more than one hand shake! The deer, once out of sight of the drivers, begin to settle. Again the men close in as before upon them.

If the deer have been already fired at on these passes they are very suspicious, and it is not easy to force them on; but they dare not go back, as they fear the danger behind them. At last an old hind trots forward, a few more follow her, and they get through the passes safely. The rest take courage and sweep down after them. First come the hinds and small beasts; the heavy fat stags keep well in the rear, partly perhaps from motives of prudence, partly, being fat, from want of wind. The drivers now look on and watch the result. Presently there is a sudden scattering of the deer, a white puff of smoke and a big stag rolls over, as the echoes waken to the sharp crack of the rifle. Then another, and another shot. The deer break in all directions, some making for the place where one gun is posted, some for another.

For a few moments the excitement is intense, as one big fellow after another bites the dust; some are wounded, more are missed, while others who have not reached the guns break back. Now is the chance for the gun with the drivers, and a fast man who keeps well the vantage ground of the hill may get the best deer of any. The drivers then join the guns, the dead are galloched; arrangements are made to follow the wounded, perhaps a second drive organised.

It often happens that no forcing on the part of the beaters will induce the deer to take the passes. They have got a puff of the wind or have seen something suspicious, and have made up their mind to break back. The last chance for the guns must now be tried. One gun must jump up, and show himself,

moving towards the deer, and shouting. Probably the herd will then at once break close past him ; for, as already said, they are less afraid of a visible than a suspected foe.

Usually a hind or small stag leads the way, but when real danger threatens, or when deer are fairly bothered, the best stag of the lot takes command. It is a gallant sight to see him trot out from the midst of them, lead the whole herd through the danger, then drop back again into his old place. On such occasions nothing will stop them.

The next mode of driving is far less sporting. A great number of beaters surround the ground to be driven, they advance in line or semicircle ; the deer see themselves attacked on all sides but one, they at first make for this open side, once or twice they advance, the beaters press on. While some go forward to the guns, many, and especially the best stags, refuse. They take a good look at the line of beaters and then charge through the middle of them, and escape. The chief art in this kind of driving is in placing the guns ; but as the essence of the sport and the chief pleasure to be derived from it consist not in the slaughter of numbers but in the selection of the best possible heads or weights, this way of killing deer cannot on true sporting principles be held to approach either of the former.

Wood-driving, as also wood-stalking, depends so much on the character of the woods that it is difficult to lay down any rules. The guns must of course be placed clear of the wind on the passes. A few beaters generally suffice if they know the wood, and they should make no more noise than is sufficient to enable them to keep the line. As a rule a wood should be driven up wind ; for cunning old stags, however, it sometimes may be well to try down wind, placing some guns in rear of the beaters. Either way, but especially when beating a wood down wind, there is a good chance for a gun through with the beaters ; the old deer, hearing the men, often break back up wind to the guns in rear, or stand in the clean wind between the beaters till they are past. Often too they lie down to hide. If a beater sees a big stag hiding in this way, he may keep him

there for hours, simply by not appearing to notice him, remaining full in sight, and continuing to talk loudly ; meantime sending the next beater for the nearest gun. This gun must walk boldly up to the still talking beater, recover his wind, and make ready. As soon as silence is proclaimed the stag will probably try to make a bolt of it.

In stalking or coming through with the beaters the sportsman must keep eyes and ears open, and he should carry his rifle himself, and have it at least half out of the cover. Deer standing in a thicket are hard to see, and rushing through the trees they are hard to shoot. If obliged to take them running past in thick trees, it is best to take the chance of hitting a tree and to aim as in the open. An endeavour to dodge between trees will probably lead to a miss or to sending the bullet through both haunches, and there will be unpleasantness when the stalker gets home.

Be careful to observe any very fresh and large tracks ; they probably denote big stags in the vicinity. A stag's track is larger and more square than that of a hind, rounder at the heel and less sharply pointed at the toe. The length depends on the ground the deer inhabits. Soft ground and idleness let the hoofs grow long, hard ground and long travel wear them short. In all wood work a good tracking dog is indispensable, a wounded deer is so hard to follow and so easily lost in rough ground and thick wood. The dog should be trained to be perfectly silent, to follow close at heel, and to remain quietly behind with anyone. He should be used only on the blood track, and never slipped.

A good collie will often track without a leash, and never attempt to bolt. He will take up the track the following day, and sometimes on the third day. Always trust the tracker. He need not be exactly on the track, if he has the wind of it all is well.

At the pass the red deer come out first, then the roe, hare, &c. When, therefore, the roe come by, your chance of a stag is small unless it be of a cunning old fellow that has been hiding.

Moving deer is a combination of stalking and driving. If it is not possible to get within distance, the sportsman must place himself where the deer are likely to pass and have them moved towards him. This is often necessary with large numbers of deer, and frequently requires as much stalking as the quiet shot.

The best dress for hard work on the hill is :—

Flannel shirt.

Tweed shooting-jacket, with plenty of pockets covered by flaps, otherwise things drop out in crawling, especially when going down hill.

Waistcoat long, with four pockets, one inside for the watch.

Knickerbockers loose, as they dry more quickly after a wet crawl, and when wet are less uncomfortable. Where there is much crawling (and in some ground there is more than on others), have the knickerbockers double at the knees. They should be made long enough to meet the hose when required, or the midges will dine freely.

Cap, close fitting so as to show as little as possible above the head—this is most important when you are on the sky-line—with a peak fore and aft, as shelter against sun and rain.

A plaid or short cape or cloak, which should be water-proofed.

Colour, neutral tint, not too dark, but also not very light. The colour should be adapted to the aspect of the country and ground.

Stockings of strong worsted. We have seen a man out stalking in silk stockings. In the middle of the day his feet began to hurt him, and *he missed his stockings*. On being recommended to examine his shoes, he found his silken foot gear all rolled up in the toes thereof.

The shoes or boots should be strong and not too tight-fitting. They should have soft iron nails set well apart to catch the heather. Steel nails are most dangerous, as they slip on the rocks. To prevent blistering, soap the stockings well in the morning for the first day or two.

Let the pocket-handkerchief be white or of a bright colour ; it will be found useful for signalling. Carry a grey gauze veil in your pocket to protect the face (if necessary) against midges. Also a large knife, containing corkscrew, tweezers, and pricker : nothing else, as the blood will rust the steel.

Have a small cap-pocket for cotton-grass, and always keep it filled, to test the wind. Also a small flask of pure 'mountain dew' is to be recommended ; do not water it, there is always plenty of that commodity on the hill. Always have some lunch in your pocket, and keep some over at lunchtime, as you never know when you may get home. Never go to the hill without some rounds of ammunition, in case of being separated from your men. Have a strong hazel stick, and let it be a good length to use as a drag going down hill. A good glass is indispensable.

Carry your rifle in its cover, as the glance of the barrels is seen for miles.

Do not drink any water for the first three days, and you will require very little for the rest of the season. If, on a hot day, you drink at every spring, by two o'clock you will feel like a water-butt only fit to roll down hill. If very hot and thirsty, turn up your sleeves and immerse your arms up to the elbows in water. It cools the blood, and doing so quenches the thirst. Do not be afraid of sitting or lying on the wet ground ; nothing of the sort hurts you on the hill if you change at once when you get home.

Get out early in the morning ; the hill is much easier to climb before the sun is high ; the deer are less difficult to find before they lie down for the day, and when moving and feeding less suspicious. When thus employed they will often allow you to slip past them, thereby perhaps saving you several miles of circuitous walking. When stalking, never talk above your breath ; many a deer has been lost by neglect of this simple rule ; for on the hill sound travels to great distances, especially upwards. Sit on a hill-top on a quiet morning and observe how everything is heard for miles round. Nothing alarms deer more, or is heard farther, than a tap on a stone,

especially if a piece of metal be used ; therefore never have an iron or other metal ferrule on your stick. Deer care very little for noises about farm-yards or houses, or such as they are accustomed to hear upon the road ; you may shoot grouse over dogs, with all the accompanying noise, constant shots, &c., and though full in sight, deer will pay little or no attention ; but attempt to approach them, and they seem to know by instinct you are in pursuit of them, and will be off at once.

If you come on to deer unexpectedly and they see you, walk on boldly ; if within distance make ready, and get whoever is with you to walk on, while you halt and take your shot. Should they be far off, continue on your way till you are out of sight, then watch them for a few minutes unseen. If they do not move when you disappear, they will probably remain where they are, thinking they have not been observed ; you may then leave them or stalk them.

In animals, the senses of sight, hearing, and smell seem proportionate to their size. They are stronger in the red-deer than in the roe, in the roe than in the hare, and so on. Before a stag lies down or begins to feed he surveys all the ground about him ; he sees all quiet, and then trusts to the sky-line, which he watches most jealously, and on which he sees the slightest change or movement. You cannot therefore be too careful when you are on what *to him* is the sky-line, and of course that depends on his position. A sudden appearance or disappearance of any object, such as a man's head, will not escape him. Once between that line and him, although full in sight, by moving very slowly and steadily in good stalking colour it is curious how much can be done without attracting his attention. Of course, if he does notice anything you must remain perfectly steady till he is satisfied that you are only some immovable natural curiosity. He will sometimes lie down to watch you for an hour or more, pretending to look away and then back again at you, and if he sees any change in your position he will probably decamp. If only a young deer sees you there is not so much danger, as they are not trusted ; but if an old stag is

really alarmed, or what is worse an old hind gives her terrible 'buagh,' there is little hope for you. Everything below him the stag sees and scrutinises carefully, and when anything moves, whether it be a grouse or hare, or worse still, a sheep or deer, he watches very suspiciously the direction whence they come or in which they are looking. As it is far more difficult to hide or escape observation below than above, it is always best if possible to stalk from above. On uncleared ground the stalker has no worse enemy than an old sheep. When she sees or suspects a man in the neighbourhood, she emits a most uncanny sort of whistle which gives the alarm to every sheep near, and at once they all begin moving. It is almost as difficult to stalk among sheep as deer, and goats are even worse.

The hearing of a deer is acute as regards certain sounds, but about others he cares little; he seems to decide very quickly what sound means danger and what does not. Like seals, deer seem to enjoy music, and will go on quietly feeding when the pipes are being played within a few hundred yards of them. On one occasion a wedding took place at a forester's house, and music and dancing were kept up till long after daylight. A number of good stags, attracted no doubt by the cheerful strains, settled in a thick clump not five hundred yards from the house, and in spite of noises of all sorts remained there all the morning. There they were discovered, and more than one fine stag paid for his entertainment with his life.

A deer's sense of smell is most extraordinary. It is his greatest protection, and the stalker's greatest difficulty. So delicate is it that he will scent a man at the distance of a mile, and will often refuse to cross a man's track when it is many hours old. The scent, of course, is carried by the wind, and the great science of stalking is to determine how the wind blows on a given spot. This depends partly on the strength of the wind, but chiefly on the shape of the ground.

On level and even ground the wind blows fair, but in glens and hills and carries it varies much. Watch the clouds of mist

on a hillside, they will teach you much more than any written rules. One or two hints on this matter it may, however, be useful to give. Wind blowing downhill is never steady, besides which, it prevents any approach from above ; therefore with a north wind do not select a beat having a southern exposure, and *vice versa*. The wind along the side or up a hill is far steadier. Deer never lie exposed to the wind, but behind something that gives them shelter. The air is moving in this shelter quite enough to carry the scent if in the right direction, and generally comes two ways. To explain this, place a lighted candle behind a bottle and blow hard on the other side of the bottle. If you blow straight the light will flicker on both sides, but if you blow at all from one side you will extinguish the flame. So it is with the wind behind a hillock, only that the wind often comes over the top as well.

Occasionally a shot may be obtained in rather a curious way. Suppose deer are lying on a steep face with southern exposure and a strong north wind is blowing. By running quickly to the ridge down wind your scent is carried over the deer and comes back to them from below ; to escape it they move up the hill and meet you.

Again, suppose a glen running east and west with a north or south wind, i.e. across it, the wind halfway up the hill will blow up or down the glen as the case may be. Nothing but long practice can really teach the sportsman the peculiarities of the wind, and, as already said, the mist is the best instructor.

STALKING.

Before a day's stalking go to bed early and get up early next morning, eat a good breakfast, and put your luncheon into *your own pocket*. See yourself to your rifle and ammunition. Men have been known to go to the hill twenty miles off without either. 'Oh, I thought so-and-so had them,' &c., &c., they say ; but the mischief is done. You will probably have with you a stalker, two gillies, and two ponies, perhaps a tracker,

nowadays seldom a deerhound. The first operation is to reach a spot from which you can see your ground, and this is dependent, as well as the beat, on the direction of the wind.

Of course the right thing would be to find your deer and stalk him for yourself. If really an expert, one man can go where two cannot, can watch the sentries, hide behind a smaller stone, in a smaller hole, and in fine take many liberties that two or more would not dare to take. To such we present our congratulations, and presume not to offer any advice. For perfect success a long apprenticeship is required, for there is much to learn. The beginner must trust implicitly to the stalker; by degrees he will be able to work more and more for himself, but at first he should limit his ambition to doing exactly what the stalker does, learning what he can from him, and submitting to his advice. His first independent attempts should be on hind or a roe, with or without a rifle.

The first thing to be done is to look for your stag. Observe how the wind blows, and what spots on the hill are sheltered. There you will find the deer lying, and you must look them all over most carefully, for a deer a long way off is very hard to see. A glance over the rest of the ground is enough, for if deer are there exposed to the wind they will be on the move or feeding, and are then easily seen.

You have found a good stag, but do not shut up your glass. You must scan every shelter more carefully than ever, lest some hind or other deer should be lying in the way. If there be none, your work will be comparatively easy, but the glint of a small horn or the quick twitch of some old hind's ear tells you that more may be lying in your way, that you must arrange your plans accordingly. To get near your stag you must move nothing he can see or hear, or that will pass to windward of him—in either case he will at once be off. You must then observe what ground he or those with him can see, and what burns or hillocks or rocks will cover your approach to the firing point about a hundred yards from him. You must make quite sure you will remember where he is, and take up some

points of latitude or longitude that will be easily seen as you approach him.

As he is lying in the shelter he is most likely between two winds. You must not get into either of them. As he can see well below him, you must approach him from above. One of the chief difficulties of stalking is a right knowledge of the ground, knowing from a distance what will cover you, and remembering during the stalk exactly where you are.

It may be hours before you get near your stag, but you must not forget your points and the general aspects of the ground, for you may constantly have to change your line of attack. It adds much to the interest of your sport if you get the stalker to explain what he proposes and his reasons. If the stag is lying at all exposed to the wind, you had better wait a little, as he will probably shift his quarters to better shelter. Otherwise you move slowly till out of sight—one last look to see that all is quiet, and on you go. The stalker leads the way, you follow in his track, the gillies either follow you or remain to signal any change, to watch the stag if wounded, or summon the ponies if he be killed.

In hill-walking the best formation for two or more is single file. You have the smallest front; the leader takes his own line, often a track of some sort, those behind can use all their eyes in looking out, you can all stop or move at once together. Always take it easy at starting, increase the pace if you like when once you are warm, and have got your second wind. Take care not to knock your stick against stones or to talk above your breath. If, in rough ground, you trip up, or slip, *drop at once*; don't attempt to recover yourself. A good hill-man slips, drops on one knee or altogether, and picks himself up again, scarcely losing his stride; a bad one stumbles on in vain hope of saving himself, and falls heavily into a bog or on to a rock. There is as much art in falling on the hill as in the hunting-field.

But to the stalk. All goes well at first; a round of two or three miles must be taken to keep covert and get the wind.

Suddenly, in the burn before you, you find some hinds and calves. They have not been alarmed ; but you cannot pass to the one side, the stags would see you : or to the other, the hinds would get your wind. You must move them quietly without frightening them. We have often seen the following plan succeed, though it is a dangerous one.

One man watches (unseen himself) till only a calf is looking his way, and then pops his head up. Instantly the calf stares at him, and down goes the head. The calf jumps up, staring hard. The old hind looks hard too, but seeing nothing goes to sleep again. Again the man makes signs to the calf, who gets more and more excited and once more attracts the attention of the hind. This time she gets up and watches for some minutes, but seeing nothing puts down her head as if to feed, then suddenly raises it up. She repeats this performance three or four times, but still sees nothing. At last the calf runs up to her, rubbing against her side and still staring fixedly at the place where he saw the strange sight. The hind will then probably move away to some little hillock for a better view, when, though she can make nothing of it, she seems to conclude that things are not looking quite canny, and walks off quietly to a little distance. This is all you want, and you get past. Often the hinds move round into the wind, give a loud 'bough!' and away at once ; and with them, probably, your stags.

You are now approaching nearer the stags, when up gets an old cock-grouse crowing. Down drops each man at once, and in a minute or two you anxiously scan the ground to see if any animal has been disturbed. The stags have heard the grouse, and some are on the alert. And now observe how they are lying. There are seven or eight of them, and their heads are turned in every direction ; though all have heard the noise, each looks only to his proper front.

You must wait till they are quite settled before crossing in view, and then you will have to proceed on hands and knees. Observe the stalker and copy him exactly. At first ordinary crawling will do, but as the ground becomes bare you must sneak

down till at last you are lying quite flat on your face, working snake-like along the ground. When in sight let all your movements be very slow. Don't think of the wet; let the water run freely between your waistcoat buttons. It won't hurt you if you get your stag. After perhaps half an hour's crawl, you get under covert. You are now within about three hundred yards of the stag; you must move with the greatest care. At length the stalker points out to you the stone he undertook to take you to, and indicates the direction of the big stag. If you are new at the sport you will probably find your heart now going 'twenty to the dozen,' your hand shaking; you want at once to get hold of your rifle, perhaps cock it. But no—wait, till you are quite cool again. Follow on now till you reach the stone, but don't show your head above the stalker till he signs to you to raise it. With your face close to the side of the stone you peep cautiously round the corner of it, and see the stags in front of you feeding quietly in the open. Again you feel your heart thump against the ground, so wait; slowly lower your head, put your feet alongside of the stone, and gently push them down till you are lying alongside of it. Then slowly raise yourself to sitting posture, bring up your knee and rest your left elbow on it ready to fire. The best stag is end on; wait till he turns broadside, or what is better one quarter off. Then take a deliberate aim, not at the whole stag, but at a particular spot, and in the position indicated that spot should be about six inches behind where his fore-leg touches his body and about half-way up his body.

Then, when you are quite steady on it, gently press the trigger and listen for the thud. If the stag pulls himself together and goes off at fifty miles an hour, he is probably shot through the heart, and will roll over dead in a hundred yards or so. If he drops to the shot beware; he will probably rise again. If the spine is bruised, but not broken, he will soon begin to move first his fore-feet and neck, and then drag himself along trailing his hind-legs. If you do not look out and give him the knife, or another bullet, he will improve his pace, recover his

legs, and wish you good afternoon. We have known deer hit in this way revive by the bleeding, and run long distances, after the knife has been in.

If you have a second barrel, aim carefully, but quickly, at the next best, and load at once.

Above all things, do not jump up and shout. If you keep still, you may get another shot. The deer, confused for the moment, may not know from whence the sound comes, and seeing nothing, will at all events not go so far as they would if they heard or saw you. Besides, a wounded deer, not perceiving the source of danger, will probably soon lie down, whereas if he catches sight of his enemy he may go for miles. Therefore, after your shot, lie still till all the deer are out of sight, unless, of course, there is reason for a run-in.

Some ardent sportsmen continue firing as long as the deer are in sight: nothing can be more unsportsmanlike. You frighten, not only those deer, but every stag in the neighbourhood, and probably wound some unfortunate animal, perhaps condemning him to a wretched life or a miserable death.

Having killed your stag, you must bleed him. Plunge the knife into the lowest hollow in his chest as he lies on his side. Give it one turn round, and the heart's blood will pour out. A deer is often not quite dead, even when he appears to be so. You should put him out of pain as soon as possible. If he be very lively, another bullet through the jugular or in the neck close to the head, will soon settle him. If you think you can manage him, and do not wish to make a noise, use the knife, but remember never to stick him from the front. His fore-feet cut like razors, and a thrust of his horns, especially in the early season, when not quite clear of corroded blood, is exceedingly dangerous. You must attack him from behind. If lying on his right side, seize his left horn, press the right one into the ground, and get your right foot on it, and as much weight as you can. Then, with the left hand, seize the left fore-foot, draw it at once straight along his body, and it is powerless. Steady yourself, and with your right hand plunge

the knife into his chest. Be ready for a desperate struggle. If you can do so, hold on for a moment; if not, jump back, and stand clear.

The deer is now dead; the next thing is to gralloch him, but this operation need not be described here, as no one will have to perform it who has not often seen it done. Suffice it to say, that it should be done *thoroughly*, and everything taken out but the kidneys. It is not fair to count a deer clean with liver, lungs, or heart left in him. All these, as well as the poch bhui, &c., must be out, and he must be weighed at 14 lbs. to the stone, with no allowance for blood, or lying out a night, or any such nonsense. The next thing is to signal for the pony, put him on, and send him home. Deer should always be bled at once, gralloched as soon as possible, and got home the same day, as going for them the next day disturbs the ground. If you are obliged to leave them out, do not cover them up too closely. In hot weather, unless you keep the flies out, they will be blown in a few hours; but in cold weather, at the end of the season, turn them on their backs—fix a stick so as to keep them well open to the air. It is advisable to tie a flag to the horns, to keep away foxes, ravens, &c.; also raise a small cairn on a conspicuous spot, and take your bearings correctly.

To enable you to select the best stag, you must know what to look for. The merits of the horn are length, span, beam, and length of points, especially on the tops, which should be sharp with white tips. Blunt tips denote young stags. An old back-going head, though the coronets remain large, is thin, has short slender points, and looks too small and light for the body; the face is grey and hard-looking. The points of the body are fat and weight. The stag should be short in the leg, long in the body, deep in the flank, and round; coat sleek, with a grey or deep brown tinge. A well-defined black streak down the back generally betokens a good stag. A very red stag is nearly always poor, having only lately shed his winter coat. The season for stags should not begin till they are clear of

velvet, about the 12th or 20th of August ; it ends not later than the 12th of October, sometimes earlier.

In shooting hinds, if you want the fattest, take the blue slate-coloured ones, light in the flank, with short sleek coats. These are probably what are known as yeld hinds, that is, animals which have not had a calf during the year. The dark brown deep-flanked hinds are the milch cows of the herd, and should be spared.

If you are merely thinning down the stock, sometimes a necessary business, take the little shrunken-looking old ones, ragged and red in the coat. They are at all events useless, and well out of the way. Hinds are in the best condition from about the 10th of November till the 10th of February.

As the shot is the most important part of the whole performance, for on it depends the success or failure of the day's work, so also the actual getting the shot is the most difficult ; causes of failure are many, and mischances frequent. The great secret is to know exactly how and when to take your shot ; some men want to fire at too great a distance, some are anxious to get too near.

The first thing to learn is how to judge your distance ; and it may be said that as a rule the stalker over-estimates it. Often you cannot see the intervening ground, or the deer may be across a hollow. There is one rule which we never knew to fail (except on very steep ground), and the act of thinking of it is useful, as it serves to keep you cool. Of course, it only applies to people with ordinary—that is, fairly good—sight. It is as follows :—Up to eighty yards you can see the deer's eye distinctly. Up to 100 yards you can see the dark line of the eye, but can no longer distinguish the shape. Up to 150 you can see the ear well ; at 200 yards you can hardly distinguish the ear at all. Two hundred yards is quite far enough to shoot at deer, so unless you can see the ear do not fire. If you can see the eye, there is no occasion to put up any extra sight. This rule, however, will not apply down a very steep hill. A downhill shot is the most common of all,

and if the hill be steep, the oftenest missed by young stalkers, for two reasons.

Looking down on a deer, the depth of his body is very much fore-shortened, and there is really less to fire at; also the deer is practically, as regards the bullet, not so far off as he looks.

You must judge his distance horizontally, not vertically. If he is 200 yards off but only 100 horizontally, the 100 sight should answer the purpose. If a deer were standing at the foot of a rock 200 yards straight below you, you could drop a bullet on him from your hand.

The trajectory of modern rifles is so flat that much less allowance need be made for shooting downhill than with the old-fashioned ones. Uphill the same rule holds good, but to a lesser extent. Above all, in shooting at a deer do not aim at the whole animal. Always aim at a particular spot, which is not so easy as it sounds when you have got his evenly coloured brown hide to shoot at. If there were a bull's-eye painted on every stag his life would not be worth a week's purchase.

The object is to place the bullet in the heart or some vital part. If the deer be standing broadside, aim just behind the shoulder half-way up the body. If possible let the deer turn about one-quarter from you, i.e. his head rather farther from you than his tail, then aim at a spot in the centre of his body, and the bullet will rake forward into heart, or lungs, or arteries. Avoid firing at a deer standing or moving half turned towards you; shooting forward enough the bullet may glance on the shoulder blade, or if hit further back go through less vital parts, and the deer, though badly wounded, is lost. To a practised shot we should recommend taking a stag as he is found, and not waiting too long for an improved position. We should even be in favour of taking him when lying, after a careful examination of his position, and aiming accordingly. At stationary deer do not be above taking a rest if one is available, but not a *living* one, such as the stalker's back; the slightest movement on his part ensures failure. A hard rock

is as bad, unless well covered with moss or something soft ; the explosion causes the rifle to jump, and the bullet flies anywhere.

In firing at running deer there are several points to be observed. In the first place accustom yourself to shoot in any position. Secondly do not use a rest. Distance also has to be considered. Shoot with a moving hand and aim well in front of the deer. Follow him for a little while with your rifle, then throw it forward according to the pace he is going, and press the trigger. Shooting a long way ahead with a stiff hand is a great mistake and never answers with any kind of game when in motion.

A deer running on rough ground is always hard to hit. The best way, therefore, is to cast your eye forward on his line, choose a level bit, and take him as he crosses it.

After your shot carefully watch the deer at which you have fired. If he gradually drops to the rear he is most probably hit. When firing mark the exact spot where he is standing or running and some spot he passes after the shot, that you may without delay examine the track for blood. Do not be too soon satisfied that there is no blood, for it may not show for some distance. Particularly examine any cairn of stones or long heather or bracken where he enters them. Many a deer is lost because these simple precautions are not taken.

In crawling, imitate the stalker exactly, and keep your head below his ; but let your head be the highest part of you. A tiro generally begins to crawl nose and toes on the ground, the more observable portion of his body high in the air. He then wonders why the deer are alarmed, and goes home and blames the stalker.

In finishing your stalk be very careful not to move too quickly. Only practice can teach you when the deer really see you, but they always bend their ears towards any object of alarm. If a deer suspects you, keep perfectly still till it look away, then move on very slowly. Take care of the glistening of the rifle and glass—there is nothing that deer see farther.

Generally, however, even when they do suspect you, you have time to raise your rifle slowly and take a steady aim.

At first it is difficult to pick out the best stag, and even to see the stags at all. Experience alone will teach this.

Sometimes it is necessary to put the stag up; but this must be very carefully done. The best way when feasible is to send the stalker round to some distance with orders to make a little noise. The



deer rising will generally stand for a few moments, and you get your shot; but if the noise be made too near, the best stag will be last to move, and then bolt at once.

As a rule deer will get up and turn round, or change their beds about mid-day, and will rise to feed between 3 and 4 P.M., or earlier as the season



'Cold and deep was the ford.'

advances. Late in the year they do not generally lie very long, though occasionally a cunning old stag may do so, and they therefore require dodging.

We remember one season a loud roar used often to be heard after dusk and through the night, betokening a big beast in the vicinity, but in the daytime nothing but a large track was visible to account for it. One cold snowy morning in October the writer was down near the spot before daybreak, and was rewarded by hearing the roar on the other side of the river close to the ford. As the morning dawned, the animal's great black form was discernible among the hinds. Cold and deep was the ford—but it had to be done, and we were just landing when the unwelcome sound of a cart was heard on the stony road above. The stag also heard it, and with a grunt or two he quietly left the hinds; as we came in sight of them he was stealing away into the thicket. For more than an hour we waited, but in vain; he had left the hinds for the day.

At last a look-out signalled that he was lying some way off in the wood. On we went, and after a time perceived him with only his horns visible in a tuft of heather and juniper bushes, on a flat bare space very difficult to approach, about a quarter of a mile off. It was a long very bare crawl to get within a hundred and fifty yards of him, and then the question was, how could he be made to show himself? Finally it was settled that if enough of him to shoot at could not be seen, on a given signal the stalker was to go round to the other side of the wood, and imitate the sound of another stag approaching from that direction.

Presently, the signal being given, curious grunts were heard in the distance, and sounds as of an angry stag burnishing his horns against the trees. The old fellow listened, but evidently was in doubt, and only lowered his head. Still the burnishing went on, and at last, apparently convinced, he answered the intruder with a savage grunt, then stood up and gave a tremendous roar. Poor old fellow, it was his last, for an instant after he dropped dead in his tracks.

HABITS OF DEER.

The 20th of September is called in Gaelic 'The day of the Roaring,' for on that day the rutting season is supposed to commence. Sometimes it begins before that time, often not till later, but in average years the proverb seems to hold good. The angry roar of a mighty hart is a grand wild sound.

During the season many of the biggest stags, the old and cunning beasts, remain concealed in the low ground, some in woods, some in small coverts, their presence being quite unsuspected by anybody. The ploughman is not on the lookout for tracks, and is seldom abroad before daylight. The old stag only jumps out of the little spinney into the corn-field after dark and he is in again before daylight. The harm he does to the oats is really small until the crop is quite ripe, for till then he only eats the long clover and grass between the straws. We have shot deer in the corn and the gralloch showed nothing but clover and grass, scarcely a blade of corn. The ripe corn of course they will eat, and knock about the stooks when it is cut ; but in a few days they are off to the hills, for the rutting season is at hand.

Hinds and their calves play about and trample much more than they eat, and are very injurious to the standing corn. The stags particularly dig up the potatoes in the drills most cleverly, always selecting the ripest kind. They also damage the potatoes, and in winter the turnips to which they may have access suffer severely.

Deer therefore should be carefully fenced off arable land ; an occasional monster may be tolerated, but numbers are too injurious. Stags require a wire fence five or six feet high. Hinds, as they will not go where the calves cannot follow, will rarely leap that height, but they go through the fence unless the wires are pretty close. A barbed wire three or four feet from the ground effectually checks them.

These corn-fed gentlemen are the great stags that at this

time appear in the forest, nobody knowing whence. Sometimes assuming command of a large herd, they bid defiance day and night to all comers ; others, on the contrary, lie concealed in the day, and only in the evening, leaving the rocks and thickets, steal quietly down on to the green flats, where they know the hinds will be feeding. These, as the night draws on, commence the fighting and roaring, and high jinks generally. With the morning light the old stag moves off to his hiding-place, leaving some smaller stag, too glad in his rival's absence to take command.

At this time, constant fights occur, such as have often been immortalised by the genius of Landseer, and when the rivals are equal in weight and strength, and 'Greek meets Greek,' then indeed the scene is striking and picturesque in the extreme. Many a tough encounter have we seen on the hill, but by far the finest was between two mighty harts, both well known in the forest, one a magnificent royal, and the other a fine beast who on account of a white patch on his side was known by the name of 'Spot.'

Each had for some days kept his camp of some hundred or more hinds about a quarter of a mile apart, full in sight of the other, on an undulating slope. Each guarded his hinds in sleepless watch ; both camps were surrounded by many more good stags, and they in turn by other smaller ones.

The two heroes roared defiance at one other and all the world, the other stags answering, but none dared venture into the magic circles. Sometimes a fickle hind from either camp would be tempted to desert to the rival one, and suddenly make a bolt of it. Instantly leaving his herd to the mercy of the marauders he would rush after her, and unless she had a fair start and could make good her escape, she was too glad to return as fast as she had gone, her lord pursuing her with thrusts of his mighty horns. If, however, she had got too near the other side, rather than risk all in a fight he would let her go and rush back to camp. Here all was confusion, as his rivals profiting by the absence of the chief rushed in, and off went the hinds in all directions. A few

minutes generally put all to rights, and everything went on as before.

For some hours we sat watching these performances, always hoping that a turn of luck would bring us within shot of either of the big ones, but the outer barriers of stags always prevented the chance. At last, to see what would happen, we showed ourselves on the far side of one lot. They moved towards the other camp, and both camps had to unite. Though, clearly, the great rivals had a profound respect for, not to say fear of, each other, there was nothing else for it—they were compelled to fight, and a grand fight it was.

Both must have weighed over 20 stone. 'Spot' had a fine strong head of ten points, whilst the other was a splendid royal. As the two lots joined, their leaders met, each bellowing and roaring his loudest, and shaking his great head defiantly at his rival.

They moved on slowly side by side, about forty yards apart, gradually closing till only ten yards separated them. Coming to level ground, in an instant they faced round, lowered their heads and closed. Great was the crash of the two mighty heads—for some moments they seemed to be immovably locked together, so equal was the weight, strength, and skill of the antagonists. Each got his hind legs well under him and gave a tremendous heave. Still neither yielded an inch of ground. One thrust to the side, the other met him, round they went, and round; the moss flew from their feet as the struggle raged furiously—sometimes one seeming to give way, then another more desperate dash and they were again equal.

At last, for a moment all is still, the heads are firmly locked, each steps back to rest, their deep flanks heaving, blown but not beaten, their great bloodshot eyes seeing nothing but each other.

In a moment or two they advance again slowly side by side, then quick as lightning they turn and close, but neither has the advantage of grip or ground, and the battle wages as before.

Four times they rest and four times they close, but the fight

gets feebler, the sparring is weaker, the pushing and rushing less desperate. The last pause is longer, but again they come on ; this time 'Spot,' who is the older though perhaps the heavier stag, fails to secure his grip, the royal feels his advantage, he presses him back ; old 'Spot' recovers his ground, but is again pressed back, this time rather down the brae. He feels the game is up ! With a desperate bound back and to one side he clears himself of the royal's horns, which at once dash in for his flank, his despairing leap just clears the distance, and away he goes with the royal at his haunches—beaten and disgraced in sight of all his followers.

The pursuit is short : the battle has been won. Without a moment's rest, back trots the victor to the battle-field, tossing his wild head in the air and sounding the loud pæan of victory. A superb sight he was as he stood on the green hillock proclaiming his triumph far and wide—but there he stood absolutely alone.

When the two chiefs closed, all the stags great and small dashed in among the hinds, each carrying off as many as he could. Away they went in all directions, and when the victor trotted back to the battle-field, it was to see them scattered far and wide. He did not remain long idle, and galloping wildly about, pursued first one then another of his rivals, till in an incredibly short time he had once more assembled his hinds around him. They had returned to their allegiance.

Such is the tremendous labour a great stag undergoes at this season. After a few weeks of it he is utterly worn out, and goes off quietly with a few hinds ; a little later he deserts even these, and retires to his old seclusion in the thickets. As the season advances he joins some of his old chums, and after a time they go off together to their winter quarters.

RIFLES.

With regard to rifles, all the new rifles shoot so correctly and have so flat a trajectory, that, when failure occurs, the fault

generally lies behind the rifle, not in it. In making your selection see that the weapon fits you, that it comes to your shoulder and your eye with the first intention. That is, that when you bring it to your shoulder your eye is looking at the fore-sight through the nick of the back-sight. See that the back-sight is at the right distance from your eye. If too near it is hazy, and as your sight gets older you will probably have to move it further from your eye. Let both sights stand well above the barrel or a hot sun causes a glare along the surface.

The fore-sight should be not too fine, or it is hard to see in a bad light. If you get a shot when the light has almost gone and you cannot see your fore-sight, moisten a little ball of paper or white biscuit in your mouth and put it on the spot, and you will see it plainly enough, but remember to take it very full as it will stand above the real sight.

We prefer the rifle to be sighted from 80, 150, to 200 yards. Taken full 80 does for 100 yards, very full for 130. Then 150 taken very fine will give the intermediate distances. A safety guard is better than a bolt, as the sportsman often forgets to take the bolt off, and sometimes to put it on, and it is occasionally removed in the course of a long crawl. The safety guard is always there, and only has to be pressed when you press the trigger.

The bore of the rifle should be about 450.

Many, even the heaviest stags, have been dropped dead by the small bullet of a pea rifle hitting exactly the right spot. Indeed, we once shot a hind and found that only one grain of No. 4 shot had touched her, but a bullet of about 450 has more momentum to crash through bones, and travelling farther has more chance of meeting arteries or other vital spots. The weight of a double rifle need not exceed $8\frac{1}{2}$ lbs. For a right and left shot of course a double-barrelled rifle is best, but for handiness in stalking or running, or at a pass for a number of shots, nothing can beat the single Henry rifle at 450. It is quite easy when loading yourself to fire 10 to 12 shots in the minute, and that should satisfy the most bloodthirsty. As

for bullets, we prefer the solid to the explosive or hollow. If you hit the deer in the stomach with a hollow bullet you probably secure him, and with a solid one often lose him, but where bones are touched the solid bullet crashes through them and finds some artery or vital spot. The hollow bullet often makes a fearful gash, but breaks up against the first hard substance it meets with. The latter are certainly far more destructive to the venison, as they destroy any joint in which they break up.

WOUNDED DEER.

When, as must sometimes happen to the best shots, you are so unfortunate as to wound a stag and not kill him, it is well to be warned how to proceed under different circumstances, in order the sooner to end his sufferings and not to lose him.

A deer shot through the heart generally cramps himself up together, then goes off best pace for a hundred yards or so, and rolls over dead. We have known the lowest point of the heart cut away by a solid bullet and the stag live and be shot some years afterwards in perfect health and condition, the wound, though quite defined, perfectly healed over.

Shot in the brain or jugular, he drops dead at once, as he also does if the spine be broken ; but if the spine be only bruised, the bleeding revives him, and though he drops to the shot he will soon recover. So also, if merely stunned by the blow on the skull or horn. Once well on his legs there is little chance of getting him. Therefore, if a stag drop to the shot, always have a barrel ready for him should he attempt to rise.

If shot through the lungs, unless the bullet touches some artery, he may go a certain distance, but will always work uphill, as directly he goes downhill the blood stops his breathing. You must therefore keep above him. A shot in the kidneys paralyses his hind quarters. With a broken leg he may go far. If the fore leg be broken he will prefer going uphill, and if the hind leg will avoid uphill as much as possible. If shot in the hoof, he soon lies down ; he has to use the foot, and this

causes the poor fellow great pain. If hit too far back (unless it is straight through the poch-spine, which, if a solid bullet be used, will often not hurt him much) he will not follow the herd far. He will drop behind and walk slowly on, but though he look very sick, will be afraid to lie down. Remember, that if he sees anything he can run almost as well as ever, and therefore must be approached with the greatest care.

In following a wounded deer always keep out of his sight and wind; do not do anything rash to save trouble; he often has more life in him than you give him credit for. If he has seen nothing, either at the shot or afterwards, he will probably soon lie down. A wounded deer, after once lying down, often makes off for some thicket or sanctuary he knows of, perhaps miles distant; do not, therefore, lose much time in following him. A good tracker is of course invaluable.

Wounded deer often show great cunning. They will keep down a burn in the water, or along a shallow lake side, in order to spoil the scent; they will double back like a hare on the track, and leap to one side, sometimes go round and round a small hillock so as to confuse the scent, then go off in a new direction.

Should the track dog be really at fault, first cast forward, then make a wide cast back, and examine the slot well to make sure that he has not turned back. Always look out for blood to ensure your being on the right track.

On the hill a wounded deer generally keeps to the hard ground, or to a burn; in a wood he rarely crosses an open unless it be partially covered by straggling trees.

In some forests deerhounds, either pure or half-bred, are still employed. If they are to be used they should follow up the stalk as near as circumstances permit. They should not be slipped until they see the wounded deer and the others are, if possible, out of sight, or they may follow a fresh deer and do much harm. It is very pretty to see these fine dogs dash after the wounded stag. According to the severity of his wound he goes off at his best pace, soon turns down wind, and tries to

make some burn or water. There he generally stands at bay till the rifle arrives to administer the *coup de grâce*.

When the deerhounds get up to the stag, each has usually his particular grip. Some jump at the throat, others seize him close behind the shoulder, some take the hind leg, some the ear. The grip often throws the stag, and if the dog be active he immediately seizes him by the throat. Should the stag be driven to bay, it is usually very dangerous for the dog to go in at him. He should stand some distance off, and bay him and wait the arrival of the rifle.

A rash young dog is apt to be seriously injured, for the horns are very sharp and very quick. If he survive his first lesson, he is more careful in future.

When the gun arrives he must be careful not to show himself or give his wind, or the stag may break the bay. He must also be careful not to shoot the dogs.

L.

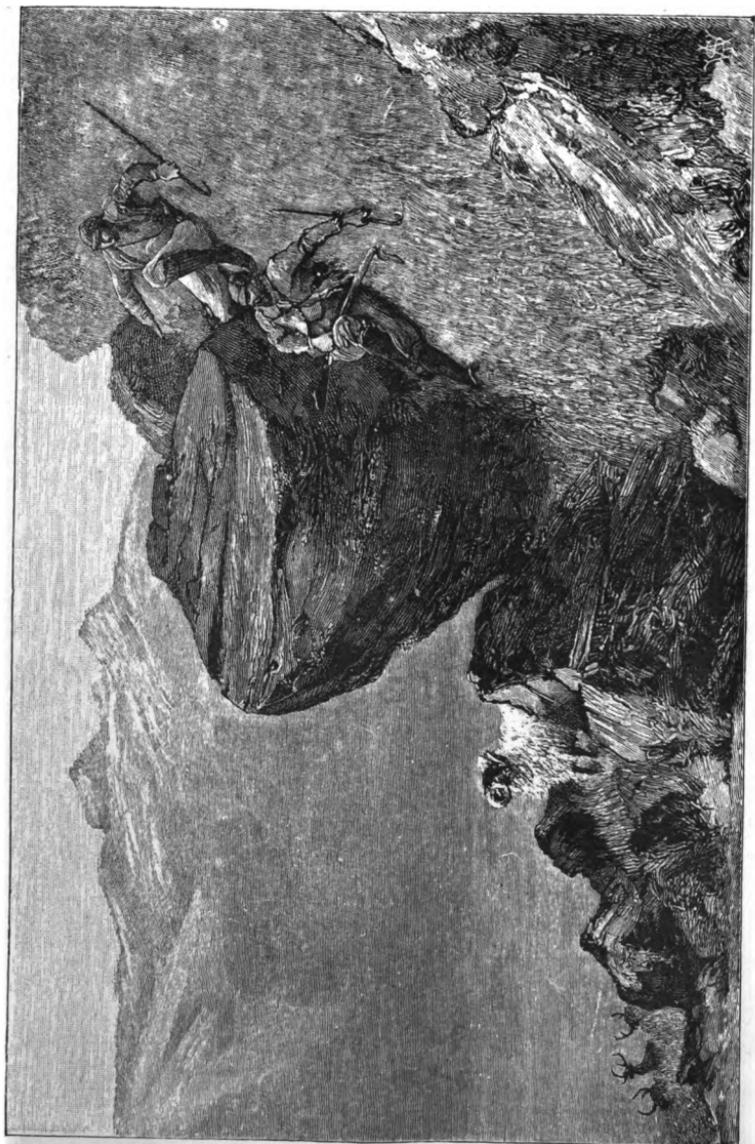

AN INTERLOPER

CHAPTER IV.

DEER FORESTS.

WHAT is a deer forest? The definition of the word is not so easy as might be imagined. It certainly does not mean a great wood, for there need not be any wood in a deer forest. In a general way it means a tract of ground cleared of sheep and cattle, and frequented by deer. Still there may be some sheep and cattle in a deer forest. Deer may, and generally do, frequent sheep farms, and both in each case may be, and are, separately let. The exact point at which ground begins or ceases to be a deer forest has not yet been legally defined.

The deer, however, soon find out what is forest and what is not. When the ground is under sheep, the few deer on it mostly keep to the rough ground, and parts least frequented by sheep or shepherds; but when cleared they quickly assume their natural habits and instincts, and also rapidly increase in numbers. Moreover, the big stags are particularly partial to newly cleared ground.

As we have already explained, in olden days the deer and wolves and wild animals had the high rough mountains pretty much to themselves. When sheep farming was first introduced into the Highlands in the end of the last and the early part of the present century, the whole of the high hills first began to be generally utilised. The wolves had been killed down, but as far as deer were concerned, the sheep were even worse enemies than the wolves had been. They kept the ground always disturbed; the constant gatherings and movings, the shepherds and their dogs, left no ground quiet; old timber

forests and large woods were cut down or burned in the mistaken idea of making grass for sheep, forgetting that shelter as well as food is requisite, and that the fine old timber was most valuable.

The deer naturally diminished in number. They were of little value. Shootings did not let in those days, and even fifty years ago forests which now let for thousands were thought high at 20*l*. But conveniences of communication, increased wealth, improvement in rifles and love of sport have changed all this. These causes, coupled with the decreasing value of sheep farms owing to the fall in prices for sheep and wool and the increased expense of wintering the sheep, have rapidly raised the value, and as a consequence vastly increased the number, of deer forests. These now number about 110, covering an average of about 2,000,000 acres. The annual value, if let, is about 300,000*l*, while the amount estimated to have been spent on and about them during the last thirty years approaches the vast sum of 4,000,000*l*. So much for their definition, their growth and their value ; we must say a few words about sporting details.

A first-class forest must be of considerable extent, containing great variety of ground, with feeding for the different seasons of the year. The capability of any farm to maintain a permanent stock is limited to the shelter and food it can supply in winter and early spring. The same rule applies to a forest. For winter there should be low rough ground, with good winter feeding in open weather, plenty of long heather and woods for protection and food in time of snow ; for spring, a good extent of mosses, with the cotton and other early grasses. A great mistake is often made by owners and lessees of forests, who are only in the Highlands in the stalking season. Round the foot of the hills, and in rough corries, they see long rank heather without grass, and rough woods full of big stones and long heather difficult to walk through, and with few or no deer about. They imagine the deer want the low ground for wintering, and that it should be made to grow grass ;

so they order it to be burnt. Accordingly, the grass comes up, and what then? In the winter down comes the snow, and a few inches puts the grass out of reach of the deer. In its former state, the rough heather was of the greatest use to them, affording them shelter in the worst storms, and also food; it being well known that deer will keep alive and in good condition for weeks on heather-tops. In its new state of green grass they are very likely to starve. So much for winter. Now for the spring. The same summer visitor sees a great stretch of wet moss covered with hard-looking grasses, on which he seldom sees a deer feeding, and still seldomer lying. 'What waste!' he says. 'Ten pounds will drain all this flat, and grow the best grass in the country;' and he gives orders accordingly. If the forester be foolish enough to obey the order, that 10*l.* will cost a good 100*l.* If the visitor were to see this wet moss in early spring, he would find every deer in the forest on it. The cotton grass grows sooner than any other, for some weeks it is probably the only fresh food deer can get, and they value it accordingly. There is not usually a great deal of this sort of ground in a forest, whereas there is everywhere plenty of grass in summer, far more than any stock could eat.

On the hill, where the heather is not required for the winter or for shelter, it should be occasionally burned, as the burning produces very sweet grass, to which the deer will come for miles. The burning should be done early in April, not oftener than once in ten or twelve years, and not in too large patches, so as to give an annual succession of newly burned ground. Burning in this way also helps to keep down the grouse, which are often a great nuisance in stalking, their note of alarm being well known to the deer and heard at a great distance. The simplest way of getting rid of them is not to shoot them. If left to themselves, one old pair will take possession of a large hillside, establish fixity of tenure, with no squatting allowed for their own or any other young birds. The result is the speedy diminution of their numbers.

To feed deer artificially with hay, turnips, &c., is, we consider, a great mistake, unless *absolutely necessary*. When once it is begun, it must be continued all the winter and spring, for when deer find the food laid down for them, they will not take the trouble to pick about for themselves. In hard weather, if not disturbed, they shift their ground very little, and it does not require much to keep them in fair condition. Of course, it is most advantageous, indeed necessary, to have some low meadows to which the deer can have access in open weather in the winter, for deer must have wintering just as much as sheep and cattle; and to cut off all low ground from deer forests, as some wiseacres propose, would be utterly to imperil the utilisation of all the hill ground.

In our ideal forest there should be, for the summer, high hills, rough and stony, for the stags, with plenty of good feeding for the hinds; there should be large open corries, and small ones; deep burns and green open ones, thick clumps in the woods, and plenty of heathery holes for the old stags to hide in. The squarer the ground the better. The sanctuary should be as central as possible. As the sanctuary is the nucleus of the whole forest, it should never be disturbed except on some very special occasion, or quite at the end of the season.

Sometimes all the deer in a forest will gather into the sanctuary, and no sport is to be had elsewhere; the safest plan is for one of the foresters to walk quietly through it towards evening. The following morning, many of the deer will be found in the adjacent corries. In the same way, if from any cause the deer gather into one large herd, should they be disturbed early in the day they will move on and on till night, and possibly leave the forest. Wait till evening, and fire a shot near them; at that time, as they are thinking of their suppers the different lots will lead off in various directions; the next morning you will probably find them scattered all over the ground.

As has been already stated, deer change their ground according to the season, but, if not much disturbed, and under

the same conditions, a herd of stags or hinds will generally be found in the same series of places year after year.

The herds usually originate in small beginnings, which should be carefully protected. An old hind fancies some spot and takes up her quarters there; she and her descendants keep to the place, gradually others join them, and in a few years a considerable herd is formed. It is much the same with the stags, and of course with them far more important. A few young stags take a fancy to a hill and winter on it. They are sure to return to it, and gradually more and more join them. When very young these should not be disturbed; after a time some become fit to be shot, but the herd should not be destroyed. They have established a happy abode, and if, when on a visit, the herd they are with are frightened, they will take the lead and make straight for home, probably bringing more, perhaps good stags, with them. These strangers, finding the new ground quiet and to their liking, remain for a time and will return.

Many new and even old forests are much injured by the thoughtless and useless slaughter of the poor little stags in such incipient herds. While it is a mistake to kill all the young beasts, it is equally prejudicial to a forest to denude it of all the great harts. As first-class bulls are necessary for a good herd of cattle so are first-class stags for a forest. Of course the best head is a great temptation, but in a new forest, or where good heads are scarce, it is better to pick out fat old stags with bad heads than promising young ones, though their heads may be somewhat better.

In the Reay a strict observance of this rule has raised the weight of deer, under the judicious management of the Duke of Westminster, from a very poor standard to an average throughout the whole season of over 15 stone clean, while the heads have improved in even greater proportion.

Of late years it has been the fashion to turn out great park-fed stags from England. Very soon every good head and great weight will be credited to these half-tame monsters. Many a

genuine Highland stag would be quite as heavy, and his head as good, if he were allowed to grow, and obtained good food, especially winter keep. The half-Cockneys will require all these to make them big. They have their ears marked and no one is allowed to shoot them, so of course they grow. Try the same with the most promising wild stags ; you cannot mark their ears, but you can use discretion in shooting them, and it will be found that they are not far inferior. At all events your stag will be a true Highlander, a credit to the Highland forest, and his head will be a really sporting trophy.

A forest should be divided into so many beats, each in charge of a forester. The beats should be large enough for two ordinary days' work without going over the same ground. Except on special occasions, deer should not be followed off the beat ; it frightens them and is unfair to the forester in charge. At the same time it is a mistake to allow foresters to think only of their own beats : they should have at heart the general good of the forest.

From the end of one stalking season to the beginning of another the forester's work is comparatively light ; he should not go clambering about all over the ground, for he only disturbs the deer unnecessarily. He should have certain points whence he can command a good view of his beats. He knows where his deer ought to be according to the wind and weather ; if they are disturbed let him discover the reason, if they are quiet all is right. Each forester should have a comfortable house, grass for two or three cows, and a small croft. If possible, the whole should be enclosed from the deer. It is far better that foresters should not keep any sheep. They are apt to multiply considerably, especially when the shooting tenant is in the south.

If the neighbouring ground is under sheep and not fenced, the forester will have plenty to do. The more strictly the march is kept at first, the less trouble there will be in the long run, as the sheep quickly learn it. Good paths are most useful in a forest for getting out quietly in the morning, and home

in the dark, and for getting the deer off the hill. These paths should be made as much out of sight as possible, along burns and hollows, so as not to disturb the ground when used. They should be looked over and repaired in June, but it saves much labour to have the drains inspected as soon as the season is over.

One often hears it said that forests are let at exorbitant prices, but before forming an opinion the following facts should be considered. It takes on a rough average about five acres of good hill ground to keep a sheep all the year round, twenty-five to keep a deer. A stag is not fit to be shot till he is six years old, and as stags and hinds are about equally numerous, it takes for six stags and six hinds $25 \times 12 = 300$ acres, to give a good stag. It therefore takes 300 acres to produce a stag six years old. Hill ground is worth about a shilling an acre for sheep, and a shilling more an acre for grouse; 300 acres therefore are worth 30*l*.

Various expenses fall on the proprietor. He has to build and maintain large shooting lodges and foresters' houses, to make and keep roads and bridges in repair. Also for several years he has to lie out of rent until the forest is stocked, besides running the risk of not letting for one or more years. All this does not leave a great margin of profit to the proprietor out of a let at 40*l*. per stag—the ordinary rate at which forests are let in Scotland.

In letting a forest it is usual to limit the stags to the number it should yield without injuring it. The time of shooting stags ought always to be fixed at latest to the 10th or 12th of October. The number of hinds allowed is also usually stated, but in an unstocked forest few should be killed. If, however, they are permitted to become too numerous they drive the stags off the ground. The stags like quiet, while hinds and calves are for ever fidgeting about.

No argument is necessary to prove that, with the present low prices for sheep and wool, were deer forests abolished hundreds of thousands of acres in the Highlands would be

absolutely wasted, would yield no rent, and consequently in no way contribute to the general good ; whereas at the moment of writing in many parishes they bear a considerable part, often from one third to a half, of the rates and taxes, and in some cases even more. The rent so paid to the proprietor is usually expended in the country, enabling him in many instances to lay out money for the improvement of his property, in draining, building cottages, &c., undertakings which otherwise would be totally out of his power ; moreover, it is generally computed that a sum equal to the rent is spent in the country by the shooting tenant. The rent of a deer forest is, as a rule, considerably in excess of that given for sheep and grouse combined, and ground so let employs many more men, especially of the native Highlanders. If there be a decrease in the quantity of mutton sent to the Southern markets, there is a large increase in the meat, i.e. venison, consumed in the neighbourhood of deer forests by the native population. Venison is mostly distributed among the people, and is by them salted down and kept for winter consumption, thus forming an important item in their winter provision. Though one hears it constantly asserted that forests have caused general eviction of the people, this is not the case, and in spite of all endeavours, scarcely a single instance has been proved.

There is no doubt that early in this century sheep drove many Highlanders from their homes among the hills and glens, and much hardship and cruel suffering were endured in consequence ; but for this forests are not to blame. Later on, when sheep failed, and the hills were again bare, the only resource was to afforest them. The cry is now, send the people back to their old homes in the high glens and hill-sides. You may send them—but, *will they go?* During the last two generations, the habits, food, and requirements of the Highlanders have entirely changed, and they are still changing.

In olden days a glen containing a dozen or more families was, to use a Scotch expression, self-contained. The people grew their own food, spun, wove, and made up their own

clothes. Everyone was his own shoemaker. They lived very frugally. As long as food was plentiful they had few other wants; they seldom left their native glens, and knew little of the outer world and its many luxuries and cares. In the summer the young people took the cattle up to the shielings on the hill,¹ and remained there as long as the warm weather lasted. But when a severe winter came there was often great misery in the glen. The precarious crops of oats had perhaps been ill-harvested or failed altogether. As there were no means of importation there was little chance of supplies from without. As spring came on the cattle got so poor that they could scarcely rise, and thus this period of the year got to be known as 'lifting time,' meaning that the cattle at that time had to be lifted on to their feet. They were then bled (with the idea of strengthening them!) and the blood was eagerly consumed by the poor hungry people. In the very high glens the people could not carry on even this sort of struggling existence, and such as were able found their way South to the towns in search of work or food.

The happy times of the Highlanders of old were, we fear, chiefly, if not entirely, confined to the brief summer months. They are infinitely better off now in many ways. 'Lifting days' are over. The Highlander of the present day, however, is not as hardy as his forefathers; his wants are more numerous, and he gets everything from the shops. A home-made plaid, in former days, was the only cloak known in the country, and it lasted a lifetime. Now every lad must have his ulster and fine clothes, and the lassies, despising the picturesque snood, must spend their money in bonnets and what they consider fashionable garments.

But these things are not to be found in the glen; besides, they wish to see and be seen. They must, also, get the news and attend the markets, and, what is more to the point, be within reach of work, and therefore near towns and railroads and other resorts of civilisation. For this reason we ask, if you send them

¹ These were small hill-grazings, generally attached, as the name indicates, to the farms below, on which a small bothy was knocked up for the summer.

back to the hills and glens, will they go? And if they refuse (and there is little doubt on that head), the sheep which succeeded them having ceased to be, why should the countless acres lie waste and useless when deer will bring more money into the country and do more for the people than any other method of utilising the ground that could be devised?

Of course there may be spots, especially round the edges of forests, more adapted for human habitation and cultivation. Where this is the case such spots should certainly be so used; but, taking the forests as a whole, they are undoubtedly exceptional. Let ignorant agitators say what they like, to people the high and out-of-the-way glens as of old is an impossibility. Many admit this to a certain extent, and would allow forests on condition that they were banished to the high ground, where other stock could not thrive or perhaps even exist. Is there common sense in such a proposition? Deer are not dormice! Like other beasts, they require food in the winter; if, therefore, rent and taxes and the tenants' expenditure are to be got out of the high ground, the deer must have the necessary low ground and shelter for their winter keep.

It has been shown how easily deer are frightened by the smell or sight or sound of man, and how two or three men can move the occupants of a whole hillside, and even force deer to a given point. Threatened legislation proposes to allow anyone to walk over the hills at will, with the certain result of disturbing the deer, and often driving them out of forests for which the tenant has paid a heavy rent. Will tenants be forthcoming after the passing of such a measure?

Leave sport out of the question. Which is the most important, the influx of so many thousands of pounds into the country for a strictly preserved forest, as in the present state of things, or the gratification of the whim of some twenty or thirty tourists, who might wish to visit the forest during a season, but who, be it remembered, have already large opportunities of rambling at their pleasure over the many Scottish hills already open to them and the public? Compare the local

expenditure of money incident to the forest with that of the visits of, say, thirty tourists.

Rent paid by tenant, say . £2,000 Rates and taxes and landlord's expenditure 500 Expenditure by tenant in the district 1,500 <hr style="width: 100%;"/> Total £4,000	Expenditure by thirty tourists, bed, board, &c. for three days at 1 <i>l.</i> per day is . . . 90 Say at most <u>£100</u>
---	--

These tourists would come singly or a few together, and make perhaps some twenty-five visits to the forest.

There are from August 12 to October 12, say, fifty working days for the tenant, for each of which he pays 4*l.* of rent, and the district receives in all 80*l.* Every second day some part of the ground would be disturbed, often that on which the tenant and his friends were stalking. The deer so disturbed would leave the beat, perhaps the forest, possibly not to return for a week or more, according to the wind and other considerations. We ask again, will the tenant renew his lease under such conditions? If not, the district will receive 100*l.* instead of 4,000*l.*, and this 4,000*l.* will probably be spent abroad.

As the object of these volumes is to convey instruction and knowledge of the various sports rather than to discuss sport in its bearing on Political Economy, we forbear to enter into details regarding the political aspect of deer forests. We will refer the reader to an able pamphlet written by G. Malcolm, Esq., styled 'The Population, Crofts, Sheep-walks, and Deer Forests of Highlands and Islands in 1883.' The little work gives ample statistics. It shows amongst other facts that the mutton lost to the country by the fact of the land having been turned into forest is 186 to 100 or $\frac{186}{100000}$ of the mutton consumed in Great Britain, while one-fifth even of that is given back in venison. It states the rental of forests at 143,542*l.*, which would make the expenditure in the Highlands incident to forests in each year nearly 300,000*l.*, and this, as a very general rule, for the poorest and otherwise most useless land in Great Britain.



CHAPTER V.

THE WOODCOCK.

THE clear ringing cry of 'Mark cock!' puts a shooter as much on the *qui vive* as the word 'Tallyho!' does the hunting man.

As the much-sought-after bird goes darting by at the pace of a hawk, flitting along among the trees, first with one wing up, then the other, every gunner is ready for but half a chance to take a long shot. No one waits for his neighbour to fire

first if a cock rises anywhere near them both, and many a time may be heard the remark, 'My dear sir, I beg you a thousand pardons, but it was a cock, and I did not think you saw it, though it was so close to you.' Yet the same shooters would be most punctilious about a pheasant or a hare, and would on no account shoot at game that had got up before their next neighbour in the line, or nearer to him than to themselves—a form of etiquette seldom neglected by any but a jealous, and therefore a most objectionable, sportsman.

In a few parts of our islands, notably Ireland and Scotland, woodcock are numerous at times; beating for them is then systematic, and the birds common, so that snap shots over another man's hat are rare exceptions.

But in most parts of England a woodcock is more or less a rare bird; there are many estates where a cock may occur but once or twice in the year, though game may be counted in thousands. Cock will not frequent a covert, however suitable it may seem to be as regards water and growth, except by their own particular choice. Indeed, they are to be found year after year in one spot, whilst in another hard by, and as one might have thought equally to their taste, they are never met with.

'Have you seen any cock yet?' is one of the most frequent questions during the shooting season, for there is something extremely interesting in woodcock, both in their appearance in our woods as well as in their habits, even to an unobservant sportsman.

The owner of a good cock-covert will hear from his keeper on Sunday that as he was walking through it, he flushed more cock, without straying from the path, than he ever 'see'd in his life.' The best shots in the neighbourhood will probably each receive a letter on the following morning:—

Sunday.

Dear —,—Come without fail on Tuesday at 10.30, as one of my woods is full of cock.

Judging from what we did some years ago when we *happened* to be shooting it during frost, and when they were in, we may get from fourteen to twenty couple.

Yours —.

We have underlined the word *happened*. Now the letter should run :—

Sunday.

Dear —,—Come without fail *to-morrow morning*. One of my woods is *now* full of cock, but may not be the day *after to-morrow*. You know how cock shift their quarters in a night, so excuse short notice.

Yours, —,—.

P.S.—We once just hit off a flight of cocks in this wood some years ago, and got eighteen couple ; and though we went again to it on the next day we got none !

Woodcock shooting, though very pleasant, is the most uncertain of all sport, and the least to be depended on, for 'Here to-day, gone to-morrow' is a woodcock's motto.

The woodcock is resident with us in fair numbers, and those that remain nest freely in the south of England and in Ireland—also in Scotland, but to a less degree. Yet four-fifths at least of the birds met with are winter visitors, driven south by cold weather in the north of Europe.

In some of our southern counties, such as Sussex and Dorset, woodcock have been recorded by careful observers as nesting to the extent of from one to two hundred nests yearly, these counties, containing extensive and well protected coverts, being naturally first chosen.

The visits of woodcock in plenty to our shores depend upon the severity of the weather in the north of Europe; but a good day's shooting early in the winter may often be the result of local changes of weather, such as frost or wet. This causes the birds to gather from outlying places to spots they prefer, such as a wood on a slope facing south, their numbers being probably augmented by the few stragglers that have already come from foreign countries.

Woodcock first arrive, either singly or in scanty numbers, about the end of October, and after that date in largely increased flights. They are then often weak and in wretched condition, their flesh being tasteless and skin scurvy ; a result of privation,

which soon corrects itself. In the early winter the birds can find abundance of food, and it is well known that, like snipe, cock will become fat within a few days, so great is their voracity.

The reason that these birds at times drop on our coast in a state of starvation is the prevalence of unfavourable gales which keep them poised, as it were, between two lands—the one they have left and that for which they are bound.

The digestion of a woodcock is so rapid, and the bird requires such constant supplies of food, that it is quite unfit for a prolonged flight, or one delayed longer than calculated on when starting. For though the weather may be favourable to the birds when first they set out on their journey, it may be quite the reverse in mid-passage. There is no doubt that woodcock and many other birds of passage are frequently driven hundreds of miles out of their course by gales, which distance has to be added to that originally undertaken.

Woodcock continue to reach our shores up to the end of November, the majority of them arriving about the middle of that month. If a winter be particularly open, of course the cock arrive late, as if it is mild with us it is probably comparatively mild in the north of Europe also. Should a frost set in during December, they will then appear in our woods, and also near the coast, if in the latter case there are evergreen bushes or other convenient shelter for them at hand.

Northerly and easterly winds are those that bring woodcock to our east coasts, and they are sure to be less numerous than usual should the wind prevail between south and west, even during the hard frost which we sometimes have from that quarter. The moon has no effect upon the arrival of cock, for they will often appear more numerous after a wet, drizzly night with a north-east wind than with the same wind and a bright moon and sky.

On the west coasts of Ireland and Scotland we have known cock appear during a westerly gale in large numbers and quite exhausted. This is probably due to one of two causes—

either the birds have overshot the land with a light wind, and, when far over the Atlantic, have been driven back again by the gale they have encountered ; or else, when migrating, they have skimmed till they reached our western seaboard, and dropped down conscious that the Atlantic was no small and narrow sea, as is that between the north of Europe and our eastern coasts.

Cock, like other migrants, travel by night, and immediately after a day's rest on reaching our shores or woods disperse through the country to suitable feeding grounds, gradually feeling their way and scattering into inland parts. Should a hard frost set in—one that freezes up all fresh water and springs—they then appear again near the coast in order to feed on unfrozen marshes, and even on the ooze uncovered by the tide, as they are conscious that the air is milder and the frost less rigorous in the vicinity of the sea and its estuaries. In a moderate frost they frequent the smaller streams, ditches, and springs.

The reason that cock visit us more numerous during the prevalence of easterly gales is not, as many suppose, that these are favourable to their migration, but quite the contrary. They alight on our east coasts with these winds because they are exhausted and cannot proceed further inland.

No bird can migrate comfortably with the breeze ; it prefers a side-wind. With the wind the wings have less power, and the feathers are ruffled during flight instead of lying smooth. It is partly for this reason that birds do not rise down wind.

The birds, however, that visit us from the north, naturally arrive with an east wind, but in fair weather and light winds they would come sparingly, until forced by northern frosts to do so, when they arrive in flights.

Woodcock are often seen by day flying inland over the cliffs, but these are usually birds that have been driven landward by the incoming tide from the sandbanks and ooze on which they had first pitched. Once, when counting a number

of waders which we had shot with a swivel-gun, we found three woodcock amongst them, and the shot was fired on the ooze quite a mile from land in a northerly gale.

During a light easterly wind the direction of the flight is considered to be south-west, and this accounts for their appearance in such numbers in the south of Ireland, in Wales, Devonshire, and Cornwall.

As before pointed out, when woodcock reach what should be the end of their flight, they often overshoot the mark, being carried along by a gale, and are then forced to fight their way back again, thus appearing in a tired condition in unusual numbers on some parts of our south-west and west coasts.

Though the majority of migratory woodcock come to us from Norway and Sweden, and the countries bordering the Baltic, yet it should be borne in mind that considerable numbers visit us from the inland districts of Northern Germany, where few remain throughout the winter on account of the frost. It is probable that our southern woodcock are in no small degree added to by migrants from that country. It must be remembered that woodcock are wandering birds, and widely distributed throughout the world; and it is only when they visit us in flights that we can ascertain their movements with any degree of certainty.

The return of woodcock northwards takes place in March; they pair some short time before leaving, and when flying at that time make a peculiar piping squeak. They are very early nesters, and incubation commences towards the end of March or beginning of April. Since game preserving has been carefully and generally studied and practised, the number of our home-breeding cock has been largely increased.

Though woodcock lie close and, if undisturbed, remain perfectly still by day, they flit out at dusk. Many a cock may then be shot if the sportsman place himself so as to command an opening through which he knows the birds will appear, and is at the same time careful to face the lightest part of the sky, so as to see them as they pass him. They always emerge one by

one from a wood at exactly the same spots, either at open places between trees or at the end of a ride.

These well-known airy lanes they invariably traverse either on dark or light evenings, and so regular are they in this respect that we have known them caught, as indeed used to be a common custom, by nets suspended across their usual outlets from a wood. They fly off at this time to their feeding grounds almost lazily, for they are not then alarmed as when driven from their shelters. So close do cock creep under ferns and thorns by day that we have several times seen them picked up uninjured or killed by sticks, unable by reason of their long wings to rise clear of underwood in time to escape.

That the woodcock conveys its young from the woods to the marshes and other feeding grounds has been frequently proved by observation, but how it does so is still a moot point among naturalists—whether with its feet, or with its bill, or under its breast. We can only say our opinion, from seeing more than one in the act, is that the young are carried in the claws of the old bird, which are pressed tightly to the breast.¹

The woodcock lays from three to four eggs. The nest is made of dry leaves, placed among dead grass or ferns; often it consists of nothing but a natural hollow in the moss or decayed herbage, and it may be seen at times under a hedge or bush.

It has been said that the scarcity of cock in our islands, compared with former years, is due to the inhabitants of Norway and Sweden eating their eggs. It is rather due to the increased number of shooters, who in all parts of the world follow this bird owing to its value in the market, as well as to the more rapid means of firing which breechloading guns afford. As to the eggs, cock breed in the trackless forests of the north of Europe, where the population is extremely scanty, and where, did they wish it, the natives would find it an impossible task

¹ In the New Forest, in the year 1850, I came upon a female woodcock watering her three young ones at a rivulet. She picked up one in each claw and flew off with them. I hid in a high gorse brake close by, and saw her return in four or five minutes and pick up the remaining bird also in her claw.—ED.

to collect them. If the folk who talk thus could only see the extent of some of the woodcocks' nesting haunts in Northern Europe as we have seen them, they would at once cease to fear that the bird was in danger of extermination from such a cause.

As before noted, woodcocks feed entirely by night when in a wild state, but in captivity we have induced them to take food



Woodcock and young.

freely at all hours of the day. In proportion to their bulk their appetite is enormous. We have given a tame woodcock a large cupful of garden worms for his breakfast, and yet he would follow us about looking wistfully for further supplies.

Observation of woodcocks in captivity shows beyond doubt that these birds feed on all kinds of larvæ, on worms, both

land and aquatic, as well as on any insects they can snap up. They riddle the ground with countless holes when seeking food—even more so than does a curlew. They are often unsuccessful in their probing for many minutes together. We have placed worms on shallow trays and flower-pot saucers, and our tame bird would make several attempts at finding them before succeeding. Woodcock, like plover and many other waders, stand head on one side, as if listening before plunging the bill into the soil. They also beat the ground with the feet and bill—listening intently at intervals, as if for movements of the hidden creatures they seek.

Woodcock, like snipe, when swallowing a worm take it with scarcely an effort; it seems to slip down of itself, and in a state of pulp. The soil that adhered to the morsel, being squeezed out, appears at each side of the bill, which latter becomes more and more encrusted. It is rather to wash this off than to drink, as is generally supposed, that the woodcock and snipe require water.

Cock vary greatly in weight, and turn the scales from as low as 8 ozs. up to as high as 15 ozs.; but an ordinary well-fed bird will weigh from 11 to 12 ozs. We once picked three birds out of a large number that weighed 15 ozs. each, and a fourth that weighed 18½ ozs., but this was the result of a close inspection of several hundreds. Woodcock of enormous size have been now and then shot, but unfortunately never preserved. The famous one recorded by Yarrell as weighing 27 ozs. gave rise to great interest at the time it was obtained, which was in the winter of 1801. There really exists no reason why its weight should be doubted. These exceptionally large birds were called 'double woodcock.' The following is a copy of a letter in our possession dated December 14, 1802, written by a well-known sportsman. It refers to a letter (about this same woodcock quoted by Yarrell) in the possession of Mr. Coke, of Holkham, at the beginning of this century:—

Dear Sir,—I send you a letter copied from the original in Mr. Coke's possession, obtained at his request by Miss Hoste from Lady Peyton, in order to remove doubts as to the existence of the

double woodcock. You will, I think, agree with me that the evidence is conclusive. [Here follows letter. See Yarrell.] Besides which Lord Rous, Lady Peyton's brother, told me last week that he saw the Hadleigh bird, which weighed twenty-four ounces on the day after it was shot.¹ Lord Rous described the bill of this latter bird as particularly short and thick in comparison to its size, a description that agrees with the account of a double woodcock killed some years ago by one of the Stanhope family at Wingsworth, in Derbyshire.

It seems clear, therefore, that a few of these 'muff-cocks,' as they are called in Suffolk, have been actually bagged, but unluckily no specimen of the bird is ascertained to have been preserved or even alluded to in any work on natural history, and I fear the breed is extinct.

Many people still think that the male and female woodcock can be distinguished by the plumage, but this is an idea which modern naturalists have proved to be erroneous, as the tooth-like markings on the outer feather of the wing are absent in the old birds of either sex, though very apparent in immature specimens. The male bird, however, may possibly be distinguished from the female by its smaller size and darker plumage.

As woodcocks are entirely night-feeders, the darkness or light of the night before has much to do with the sportsman's luck on the following day. If the night be clear and the moon bright, woodcock will fly far and near to their choicest feeding grounds, and will feed freely everywhere. The result is that the next day they are heavy and sleepy, and lie well in the woods and other haunts which they frequent. If the previous night be dark and stormy, they are not able to find their favourite spots for obtaining food so easily. The following day they are therefore wild and fidgety instead of contented and resting. They are then hungry and wakeful, especially in the afternoon, as they are at that time particularly restless

¹ The Hadleigh bird is remarked on in the letter here alluded to as being another very large example of the woodcock, as well as to strengthen the supposition that one of twenty-seven ounces was in consequence no improbability.

preparatory to once more flying off to seek the nourishment of which they were disappointed the night before. It is the same with snipe and plover.

It is curious that, with all the wonderful instinct of migratory birds, they should not with certainty be able to fly on a dark night to feed on spots they have previously visited, yet this really seems to be the case from what we know of their habits.

We have seen several preserved specimens of woodcock both fawn, cream colour, and pure white, and one nearly black.

Before making remarks on the practice of woodcock shooting, we will refer to some curious events worthy of narration relating to the sport, for all shooters take an interest in episodes and notable facts connected with 'cock shooting.' Daniel records that in Ireland the late Earl of Clermont shot fifty couple of cock in a day.

We have an old letter on the subject, written soon after this feat, which excited so much interest at the time of its performance. Here it is :—

At Christmas time, 1802, the Earl of Clermont wagered that he would kill in one day fifty couple of woodcocks ; the bet was determined between two and three o'clock, by which time he had killed one couple more than his number. The bet was 300 guineas, and took place in Lord Farnham's woods in Ireland. No particular day was fixed, but Lord Clermont (then Mr. Fortescue) was to give notice on any morning that he pleased that he was about to shoot for the wager. He used two French double guns.

The above was related to me (Sir Thomas Frankland, Bt.) by Lord Clermont at Brighton, in July 1803, and copied verbatim.

Having for years mislaid the above letter, we wrote to Lord Clermont asking whether he could supply us with the facts of the bet. His reply is given below. This incident would be remarkable in the present day with modern breechloaders, but is the more extraordinary considering the date of the occurrence and the guns then in use.

Lord Clermont's note runs :—

The late Lord Enniskillen, who, like Lord Clermont, was at the

time of the bet staying in the house of the Earl of Farnham in Cavan, recollected that Lord Clermont began to shoot on that day early in the morning, and came in to breakfast much disheartened, having missed many birds and killed but few, and with his shoulder sore from the kicking of his flint gun. Lord Enniskillen advised the shooter to put some padding into his coat sleeve, by which his shooting was so much improved that the hundred woodcocks were killed early in the day, all in one large wood called 'Donaweale Wood.'

Of late years some extraordinarily good sport has been enjoyed woodcock shooting in Ireland. Lord Ardilaun has supplied us with the following extracts from his game book :—

Jan. 1878 : Five guns—106 cock in one day.

Jan. 1879 : Six guns—350 cock in one week.

On the two best days of this week there were killed respectively 117 and 115 birds.

Jan. 1880 : Six guns—365 cock in four days.

On one day 165 birds were bagged, on another 82.

Jan. 1881 : Six guns—173 cock in two days.¹

In 1884, six guns killed at Ashford 172 woodcock in one day (January 14), and on the same date in 1886, 177 fell to the same number of guns.

Muckcross, Mr. Herbert's seat at Killarney, is probably more frequented by woodcock than any place in the British Islands. The year Lord Elcho resided at Muckcross, the party, averaging five guns, shot in ten days 420 couple of cock (840 birds). In that winter there were killed in Muckcross woods 1,250 woodcock. A few years ago on this estate there were shot in two consecutive days a total of 232 woodcock.

At Castlemartyr (Lord Shannon's), 500 woodcock were shot in a season not long since.

Sir Henry Gore Booth, who lives on the west coast of Ireland, at Lissadel, near Sligo, has also enjoyed some excellent cock shooting on his estate. On one occasion he and some friends killed 300 cock close round the house at

¹ 'Fowler in Ireland.'

Lissadel in three days. Another year 338 cock were killed at the same place by a shooting party in six days. The number of guns in both instances averaged six.

During the severe weather of January 1881 a dealer in game on the west coast of Ireland bought from the local shooters 1,142 woodcock, and finished the season 1880-81 by purchasing altogether 2,021 of these birds. We are well acquainted with the person mentioned, and know that he kept a careful record of all the game he bought during that season, permitting us to inspect his daily list.

It will be interesting to compare the above with the cock shooting met with in Ireland some years ago, and this we are enabled to do by means of an article by Mr. Lloyd, the author of some delightful works on sport and natural history in Norway and Sweden. The account referred to appeared in the 'Sporting Review' for October, 1847. It will be seen that cock frequented Ireland forty years ago at least as abundantly as they do now. Mr. Lloyd writes:—

A field officer with whom I was in company many years ago told me that he himself was present when fifty couple of cock were bagged by an acquaintance in a single day! It was for a considerable wager.¹

Again, the late Lord Glentworth assured me that in 1842 Mr. Mathew Barrington and his party bagged in one day on Lord Limerick's property—Dromore Wood—seventy-two couple.

During the several excursions I have made to Ireland (writes Mr. Lloyd) I have shot hard on seven hundred couple of woodcock, and I have no doubt that, should a man be fortunate enough to get access to first-rate covers, he might readily kill 500 couple to his own gun in a season.

Taken altogether, my best season in Ireland was in 1820, when I killed, besides 1,310 snipe, 414 woodcock.

Mr. Lloyd subsequently says:—

But, after all, the cock shooting even in Ireland is hardly to be compared with what it is in other parts of the world. For instance,

¹ Probably Lord Clermont was the shooter here alluded to.

Sir Hyde Parker, in a letter to me in 1844,¹ when speaking of a trip to the Mediterranean in his yacht, says, 'We killed 450 cock in ten days, and the party who preceded us killed 650 in the same time'; but this was equalled by Messrs. Oxenden and Berkely, who bagged in twenty-one days, shooting in the Morea, 862 woodcock—their best day, 80.

The following extract from our work 'The Fowler in Ireland' describes how numerous cock are sometimes slain in that country at the present day:—

During the unexampled frost of January 1881 woodcock positively swarmed on the west coast of Ireland. Peasants out of work and farmers' sons, with old-fashioned muzzle-loading guns and converted rifles, bagged their fifteen couple a day; the best shots getting from fifteen to twenty couple.

These people often run short of ammunition, or would have accounted for many more. Every hedgeway, every ditch and bunch of furze held its couple or more of cock. About the cliffs near the sea a dozen might often be seen on the wing at once.

This slaughter continued during the greater part of January. For an entire week woodcock might have been bought at from 4*d.* to 6*d.* a couple. One dealer alone in the neighbouring town, though he had two rivals in the trade, forwarded to Dublin and London 1,000 cock a week for three weeks. The author counted laid out on benches 800 woodcock in rows—a sight not often to be seen. Nor did this massacre take place in one county alone; from every part of the Irish coast came a similar story.

In England the best cock shooting has usually been obtained in Norfolk, that county, on account of its prominent position, having a great attraction for tired woodcock when arriving from the north.

At Melton Constable, in Swanton Wood (Lord Hastings'), near Holt, in that county, a shooting party killed 105 cock in one day (December, 1860), and in most years bags of from ten to twenty couple of cock are obtained in a day in the more favourable coverts lying near the coast. Swanton Wood is supposed

¹ About that date, 1843-44 and following years, Messrs Oxenden and Oglender used to follow the woodcock all over Europe, and killed vast numbers.—ED.

to be the best covert for cock in England; the second best Hepburn Wood, at Chillingham (Lord Tankerville's); and the third best one of the Prince of Wales's coverts at Sandringham. Among other good coverts for woodcock may be named those at Sheringham (Mr. Upcher's); Holkham (Lord Leicester's); Rendlesham (Lord Rendlesham's); and at Scotts Hall (Lord Huntingfield's). The two last named places are in Suffolk, the others in Norfolk. Some heavy bags of woodcock have been made on the islands of the west coast of Scotland, notably on the island of Raasay, between Skye and the mainland, whereon over fifty have been killed in a day by two guns, and seventy-two by three. The shooting of this island belonged to the late Mr. H. Wood for many years, his annual bag of woodcock being about 500, but Mr. Wood and one friend (Mr. Fetherstone), not shooting very regularly, obtained on Raasay no fewer than 916 cock in the season 1885-6. Sir Frederick Milbank has also enjoyed some excellent sport with woodcock, as well as other game, on the Island of Harris and Lewis, the shooting of part of which he hired for a number of years. Some of his records are very interesting, and as the bags made are so well described by Sir Frederick in the letter annexed, we quote it in full, especially as a day may come when such good sport will be unheard of, save as a curiosity of the past. Sir Frederick writes :—

I have enclosed a few statistics about woodcock and snipe shot to my own gun in the island known as 'Lewis and Harris' (one of the Hebrides). No doubt I could have killed more grouse and snipe each year, but during the deer-stalking season I gave myself up chiefly to that sport. I enjoyed every variety of shooting and fishing on this island, and I do not suppose it had its equal in any part of Scotland. My residence was situated on Loch Seaforth, a loch that ran inland for the first seven or eight miles, bordered by precipitous cliffs rising to a great height, and in which there were always two nests of the 'white-tailed eagle,' and not a year without a nest of 'Peregrines.' This sea loch was quite land-bound, and was a constant source of amusement in fishing and

shooting, as many species of wildfowl frequented it ; to say nothing of a most exciting time when on one occasion 1,000 bottle-nosed whales came in.

The woodcocks were shot on the open hills, glens, and burns, where there was no brushwood or trees of any sort.

1854.	Number of woodcocks killed . . .	426
	Three best days, Nov. 24 . . .	19
	" 25 . . .	20
	" 26 . . .	19
1856.	Number of woodcocks killed . . .	351
	Three best days, Nov. 19 . . .	18
	" 20 . . .	20
	" 21 . . .	28
1857.	Number of woodcocks killed . . .	251
	Three best days, Nov. 10 . . .	16
	" 11 . . .	16
	" 17 . . .	17
1858.	Number of woodcocks killed . . .	381
	Three best days, Nov. 12 . . .	24
	" 13 . . .	35
	" 18 . . .	31
1859.	Number of woodcocks killed . . .	167
	Left the island Nov. 3.	
1860.	Number of woodcocks killed . . .	216
	Left the island Nov. 4.	
1861.	Number of woodcocks killed . . .	181
	Left the island Nov. 1.	

In 1862 and 1863 less than a hundred woodcocks were killed up to the time of my leaving the island, November 1 and 2, in these years.

After 1863, up to 1870, when I finally left the island and gave up the shooting, less than 20 cock were killed each year. Woodcocks appear to have forsaken the island, as I understand from my late forester, who still lives thereon, that now he seldom sees a woodcock. Why this is the case I can't imagine.

Snipe in 'Harris and Lewis' were very numerous. I killed in

1851 . . .	430		1853 . . .	302
1852 . . .	513		1854 . . .	355

These latter birds were shot when grouse shooting. A yearly average of 285 snipe was obtained between 1851 and 1870, and I did not at any time especially seek for them.

Grouse averaged 500 brace each year. My best day was 109 brace over dogs. I never practised driving grouse on the island.

Whilst alluding to Harris and Lewis, we will add a few notes on the stalking obtained in this island by Sir Frederick Milbank, who informs us that during the time he lived in Lewis, from 1851 to 1861, he was limited to 25 stags each season, which number he easily accounted for. In 1862 he rented the eastern part of the forest of Harris, and in the nine seasons he shot over this portion of the island he killed 70 stags each season, his total for twenty years being 905.

Good bags of woodcock are also obtained in Wales, but nothing to compare with the numbers shot in Scotland or Ireland.

In November 1885 seventy woodcock were killed in one day by a few guns on Spurn Point. This is a low range of sand hills four miles long and but a hundred yards or so broad, that juts out into the German Ocean and forms the south-east promontory of Yorkshire. It is naturally a very favourite spot for migratory birds to rest on.

The woodcock is considered the most difficult of all birds to shoot, not excepting even the snipe. This certainly is the case in a well-timbered cover, because the trees so often obstruct the aim, and the bird, instead of flying straight away, takes a zigzag course, or after a short flight darts to the right or left of the shooter.

But it must be borne in mind that almost everyone with a gun in his hand fires at a cock within—well—let us say one hundred yards. The steadiest and most experienced of sportsmen will fire at a woodcock at double the distance they would at a pheasant or partridge. Why? Merely because it is a highly prized bird, and the chance of a shot at another may not soon occur again.¹

¹ It is the custom in some places to have a 'woodcock sweep,' each shooter subscribing; and the gun that secures the first woodcock pocketing the total. This we consider an objectionable practice, as being an incentive to dangerous rivalry in shooting.

Now, if woodcock lie well, and there are plenty of them—a rare combination—the percentage of birds bagged is quite as large as it is with any of our winged game. We have constantly remarked this, and noted the success which attends an ordinary good shot when woodcock-shooting, if the birds are fairly abundant and not wild.

It is the constant and systematic practice of firing at cock at any range, in or out of reason, with the consequent frequent misses, that has given the woodcock the reputation of being such a hard mark to hit.

In our experience, partridges rising in a covert (as they do after being driven in) often present quite as hard a mark as woodcock. It must also be remembered that, with the closest shooting gun in the world, a cock could fly through the pattern in half-a-dozen places at sixty yards without a pellet touching a vital part, or even damaging a wing. It is a common remark amongst shooters that a woodcock offers an easy shot in the open. This is not always the case. We have seen woodcock on a windy day fly as tortuously in the open as in a wood, and one of the hardest chances a cock will give is when it has flown a short distance, and comes straight towards a shooter and over his head in long sweeping curves.

In woodcock-shooting it is a great point to fire the first barrel immediately on sighting the bird if it rises before you. Do not wait for it to get at a height, or in hopes of its showing plainer between the trees. As in shooting rabbits in undergrowth or furze, if you cannot fire at first sight, the chances are the opportunity is lost. Take the bird instantly with the first barrel, and you *may* have a fairly easy and deliberate shot with your second in case of a miss. If you wait for a fair chance with your first barrel, it is ten to one that should you miss you will obtain only a random shot with your second.

Remember that a cock flies at great speed and gets its pace up at once ; every instant of delay lessens the chance of killing, for the bird flies the more erratically as its speed increases. A cock will, as before pointed out, nearly always fly out of a wood

through the same openings, and if it be a 'cock-shooting day' it is well worth while to send a gun to command any considerable gap at the end or side of a covert when beating up to it.

Woodcock are always loth to leave a favourite shelter, and we have known a line of guns and beaters shoot a dozen cock when walking up a strip of cover, then right about face, and kill as many more by going back over the same ground. The reason of this is that (as is often the case) the birds which were missed and those that rose out of shot, though they went away as if going for miles, merely reached the end of the wood, turned back along the sides, and dropped behind in their old haunts. Cock will often lie very well when beaten for the second time, but try them a third time and they are hopelessly wild, though they may even then not go far away.

A cock, if really wounded, is easily retrieved, as it will squat on the ground, not even running into shelter. But it so often happens that the bird when fired at and missed flies a short distance, and then either alights, or lowers its flight to such an extent that it appears to do so. The anxious shooter in such case vows that the bird is either dead or badly wounded, and half an hour is wasted in looking for it.

In some places we have seen markers placed in tree-tops to note where woodcocks pitch on flying back or being missed forward. But the markers often call birds marked that they fancied were *about* to alight, though the birds might have only lowered their flight behind some bush or hedge and skimmed a half-mile further on. Such marking causes a deal of time to be wasted.

It is a much better plan to station markers one on each side of a wood in the fields, and well away from it, and to let them mark only the birds that fly out of covert. You will then have an idea of how many cock are flushed, and if they do not break covert, the beat is well worth doing over again.

Cock very often fly down a hedge when put up, and drop either in the ditch or just inside the covert, and it is a very good plan to direct a couple of shooters to walk round the

outskirts of a wood after beating it, one on either side of the fence.

On a bright warm day be sure to rattle the holly bushes and laurels. They will both be likely finds—the former a certain one if cock are about. The thick varnished leaves of the holly prevent the radiation of heat from the soil, and in frost are little affected by the refrigerating influence of a clear sky, so that they offer either a warm or a cool shelter for the bird as required.

Woodcock are also very partial to the sunny side of a sloping bank during winter ; we have noticed such spots hold cock in the proportion of three to one, compared to banks or hills facing north and east. Therefore, when setting out to look for cock, always try the most favoured spots first (you will soon learn them), because a cock will often fly back to these haunts, even after being shot at and missed, and so give another chance.

We have made certain of many woodcock that have been carefully marked in a hedgerow or ditch by heading them after making a *détour* very quietly, and leaving a man to walk them up to us at a given signal, when they are sure to fly from the moving object and towards the stationary one—the shooter.

If not well marked, and you are anxious to get a fair shot at a cock, take a circuit and head him, leaving a man behind to rattle a stick ; then walk the bird up yourself, and he will likely enough spring at your feet.

We have seen first-rate spaniels—Clumber and Sussex—worked on cock, but do not consider them satisfactory aids, for several reasons. It frequently happens that an easy shot at a cock is missed through the shooter paying attention to the dogs, encouraging them and so on. Spaniels that work a few yards too wide will flush cock just too far for nice shooting. They will, however, like retrievers, become very keen at finding cock, though during their first lessons they may disdain to notice them.

During the commencement of a frost, seek for cock in the drains and ditches which skirt the woods—that is, if you are shooting alone or with a friend. A number of guns and beaters would, of course, drive all before them as they walked in regular line, being able to beat the covert in a methodical manner, which a couple of shooters cannot do.

We have often picked up, with the aid of two or three beaters, on the first day of hard frost, as many as six or eight couple of cock by trying only the ditches and drains of a wood ; the same wood rarely producing more birds when carefully shot with a number of guns. For as cock are sometimes driven to the woods by one night's frost, they then naturally frequent the moist parts of it, provided they are not too wet. Water freezes less quickly under trees than in the open ; should all springs and fresh waters be hard as iron, the woodcock then seeks its food if possible among decayed herbage under the shelter of dense foliage. In the latter case they are much more difficult to flush than in the former, and require a well-arranged party of guns and beaters.

In the matter of guns and charges for cock shooting there is much difference of opinion. Many people affirm that to shoot cock in covert a gun requires to be shorter than usual by quite two inches—that is, with 28-inch barrels. We had a gun made purposely for cock shooting of this length of barrel, but found that the difference in its balance made it difficult to hit with in comparison to an ordinary gun. It stands to reason that the guns in use day after day, and built to suit in bend, weight, and length, are those one can naturally kill with best. Is it probable that, if the shooter takes in his hand a gun of unaccustomed length and balance for a few days only in the season, he will shoot as well with it as with one he constantly uses ? It is also said that a short gun in a covert is a convenience, as it does not catch in brambles and twigs when putting it to the shoulder. We never yet remarked that a covert contained growth just a couple of inches too long for a gun. No ! shoot cock with the guns you are well accustomed

to; use them both in and out of covert, and see that they pitch up to your shoulder easily and quickly.

In the matter of shot, if you are going out especially to seek woodcock use No. 8; do not mind what you may have heard said about its being too small. We have over and over again brought a cock down 'dead as a door-nail' at forty-five yards and more with this size. Moreover it gives a close and large killing circle, and that is a *sine quâ non* in cock shooting. A small killing circle makes cock-shooting very uncertain at all times, more especially in thick covert with evergreens, as they then often get up from underfoot.

If you expect woodcock with other game, use No. 7. No. 7 is but very slightly inferior to No. 6 in penetration, and gives a very superior pattern, which, as just noted, is a special requirement in cock shooting.

When game is not abundant and woodcock somewhat numerous, we have found it an admirable plan to load the right barrel with No. 6 and the left with No. 8, the latter being never fired save at woodcock. It requires a little practice to refrain from firing the second barrel, and to fire the left first should a cock rise; but that is soon learnt, and when cock are expected, it is something to be ready for them. The left barrel is, of course, first used on flushing a cock, the right with the larger shot afterwards, should a miss occur. We need scarcely say that if game were fairly numerous this system of loading would only confuse, but under the circumstances recommended, it has during a day's sport brought us many cock to bag that would not otherwise have been counted.

R. P. G.

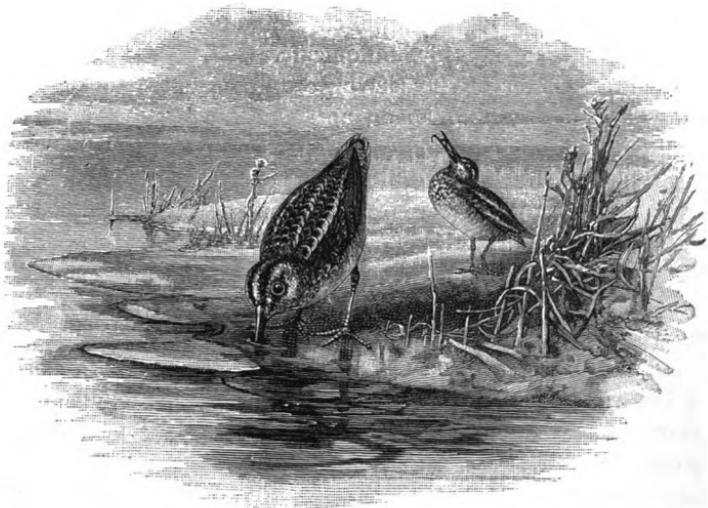

Snipe feeding.

CHAPTER VI.

SNIFE.

THREE species of snipe visit our islands—namely, the common snipe, the jack snipe, and the rarer great snipe.

The common, or as it is sometimes called the full snipe, is generally distributed throughout the British Islands, and is a resident that breeds freely in some counties which are suitable, such as Norfolk,¹ Cambridge, Lincolnshire, and Suffolk, in England, and in Kerry, Clare, and Tipperary, in Ireland, though in the latter country it nests in considerable numbers throughout the whole of the south and west. It also breeds in Scotland and in Wales to a less extent. As winter visitors snipe are common to every part of Europe; we have

¹ It is a curious fact that the snipe which nest in the fens of Norfolk take their departure regularly in September, migrating to other places at a distance, a good many possibly moving to Ireland, owing to the extensive feeding-grounds which are there available.

found them abundant along the shores of the Mediterranean and the Adriatic. In Morocco snipe are very plentiful, as well as in India, China, Persia, and Egypt. In summer, snipe frequent Siberia, and nest all over the Northern regions of Europe and Asia, and from the British Islands eastward to the Pacific.

The first great flight of snipe that visits us usually arrives about November 1; snipe seldom appear later than November 10, or earlier than October 20, but migratory birds continually drop on our shores up to December in small numbers. They so constantly shift their ground on arrival, that it is often difficult to say where they come from—whether from distant or from neighbouring countries, or whether they have but assembled from the country round to visit their favourite feeding spots, where they are suddenly to be seen in numbers.

About the end of March snipe begin to make the curious humming noise the explanation of which has given rise to so much discussion. The first egg of a snipe is usually laid from April 1 to 10, but we have found a nest with two eggs as early as March 20, and in unusually mild and open spring weather have often heard snipe 'bleating' as early as the middle of February.

Snipe feed by the sides of rivulets and small shallow pools, and are particularly fond of a tiny bit of marsh caused by the overflow of a spring; this is the first place they are apt to visit during frost. They are also found wherever they can bore for food, which consists of worms, insects, and tiny freshwater shellfish.

We have seen ten couple of snipe shot in one large field of turnips during a hard frost. The ice on the leaves of these roots readily melts in the sun, and the moisture dropping down soaks the frozen soil beneath sufficiently to enable the snipe to probe for food. We have many times noticed the marks of a snipe's bill under the leaves of a turnip, whilst the open spaces near were untouched.

But the favourite haunts of snipe are wet meadows with rushy bottoms, as well as low-lying grass fields which have been

formerly ploughed, and show ridge and furrow, in the hollows of which the water soaks and the snipe finds suitable spots wherein to obtain or search for food.

Better snipe-shooting is to be had in large wet grass fields and comparatively dry bogs, where, though the water splashes at every step, it rarely reaches the ankle, than in wet bogs and marshes. In the latter, though the birds collect in numbers, they rise in wisps on firing a shot, and so offer a poor chance of sport. For every snipe shooter knows that he may see hundreds of snipe during a day, and yet scarce get a shot on some beats, whilst in other places, though but few birds are seen, they lie well and afford satisfactory sport.

Remember, in a snipe-shooting district, that every field or marsh has *one* favourite haunt for snipe, though but a solitary bird be the occupant, or at most a couple. It may be merely a bunch of reed or a grass-grown puddle, but day after day a snipe will be found in it, shoot the birds as you may.

It is, therefore, important to a shooter to recollect all the best snipe haunts, and if he wants to make a bag to skirt from one such place to the next, beating the ground more systematically on his way home.

Snipe are very erratic in their movements, suddenly reaching, and as quickly leaving, their most favourite haunts. The moon affects them in precisely the same way as it does woodcock, causing them to lie well, or the contrary, as the nights are clear or clouded. Snipe will, however, feed by day, which cock never do, and besides this, snipe invariably shun the woods. They do not frequent streams and springs to drink, but, like woodcock, to rinse off from their feet and bills the soil, which adheres very tenaciously while they are feeding. During frost they visit unfrozen waters to feed, for where the water trickles along the ground, and the water's edge is soft and unfrozen, food may be found.

Snipe, like cock, are never in such good condition as within a few days after a frost. Nature then favours them, for the worms, that in a frost retire deep into the soil beyond their reach,

come closer than ever to the surface during a thaw, and afford the ravenous birds an unlimited supply of food. Though snipe be starving, with their bones almost through the skin, as they often are in severe weather, they will, when food is once more plentiful, become as fat as butter within a week.

It is strange, after all that has been written and observed about snipe, how little we really know concerning their habits—how they come, where they go, or when they may be expected in numbers. The eccentricity of their movements baffles the

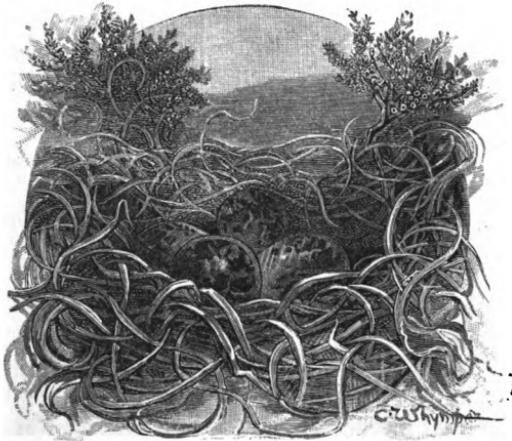

Snipe's nest.

oldest snipe shooter; no one can with any certainty look for sport with snipe on Tuesday because he has had it on Monday, though he seek the birds at the same place and under the same climatic conditions.

There is no doubt that snipe dislike rain, frost, and strong winds, and that they lie best in heavy warm weather, with a slight breeze and a falling barometer, the latter state of things in winter indicating an approaching storm. The birds, being admirable weather prophets, have then fed well in prospect of disturbance, and are heavy and sluggish.

On bright frosty days, especially during white frosts, snipe are certainly fidgety; they then look almost as big and dark as do cocks on the wing, and are easier marks than usual, especially if snow cover the ground. In a hard black frost they fly like arrows, and dart away in a moment.

The average weight of a common snipe is $3\frac{3}{4}$ ozs. to just under 4 ozs., but they have been more than once recorded as weighing as much as 8 ozs., and on several occasions from 6 to 7 ozs. We have shot and weighed many snipe of $5\frac{1}{4}$ ozs., one or two of $5\frac{1}{2}$, and a good many of only 3 ozs.

Referring to the weight of snipe, we may quote the following from 'The Fowler,' as it bears so strongly on this subject. It is a record of some snipe shooting by a famous snipe shot, Colonel J. Peyton:—

Fifty-five snipe, out of a number shot by him (Col. Peyton) during the last week of December 1878, weighed 16 lbs., or an average of $4\frac{2}{3}$ ozs. apiece. On January 8, 1879, Colonel Peyton bagged forty snipe, whose aggregate weight was 12 lbs., or nearly 5 ozs. a piece.

THE JACK SNIPE.

The jack or half snipe weighs but 2 ozs., and is becoming scarcer every year in our islands; why it is hard to say, as these birds have never been known to breed with us, and when full snipe are abundant jacks are often allowed to go away without a shot. The jack snipe is equally common in most of the countries frequented by the full snipe, but is unknown in China.

This dainty little morsel, from his sluggish habits, is nearly always found to be a ball of fat. He is considered by epicures to be of a more delicate flavour than his larger relative. If there were more of him it would be, perhaps, easier to judge of this.

Though jacks are scarce birds, and in most parts are only in the proportion of one in twenty to the common species, they will congregate on their arrival. A friend of ours once shot eighteen jacks in a day in one piece of swampy ground, though

in the same locality a couple of jacks a day among twenty or thirty full snipe was his usual average. Early in the season jack snipe are fond of frequenting small shallow pools, overgrown with tussocks of coarse grass and 'carex.' We have sometimes shot a full snipe in such places that has sprung up wild, and on sending a dog to retrieve it perchance three or four jacks would get up and flit away to the next pool.

THE GREAT, DOUBLE, OR SOLITARY SNIPE.

This is so scarce a species that a shooter who spends his time snipe shooting may expect to meet with it perhaps once in two or three years. We have shot three in a season ; but afterwards did not see another for several winters. It may be assumed that the great snipe is now and then overlooked in a bag of common snipe, as a small double snipe would bear a close resemblance to a fine common snipe.

This large snipe is without doubt a regular winter visitant in small numbers to us, and it invariably arrives between the middle of August and the end of October. It is then migrating to its southern quarters.

It is usually seen singly or in pairs, but never in threes and fours, like the common snipe. The average weight is from 7 to 10 ounces, but they may be found both under and over this weight by as much as an ounce. The Great Snipe breeds in Denmark, Holland, and Northern Germany, as well as in Sweden and Norway. It also breeds in Russia, and this species was found nesting in considerable numbers at the delta of the Petchora river by Mr. Seebohm. It rises and flies very sluggishly, and without those turns and twists that make the common snipe so difficult a mark on the wing. It may, as a rule, be easily recognised by its larger size, comparatively weaker bill, and by its having the whole of the under parts spotted instead of pure white, with the outer tail-feathers on each side pure white. The tail, too, has sixteen feathers, the common snipe only fourteen. It has not been known to nest in the British Islands.

SABINE'S SNIPE.

This was at one time supposed to be a distinct species, but is now generally regarded by naturalists as only a melanism of the common snipe. Snipe, like cock, have been obtained in many shades of colour; we have seen fawn-coloured, white, and reddish brown, or woodcock-plumaged snipe, the last being known as 'Sabine's snipe.'

One of the greatest disappointments we ever experienced in bird hunting and collecting occurred when one day we flushed a jack snipe of a colour similar to that of a so-called Sabine's snipe and missed him, not to get another shot, though we sought for the bird for nearly a week.

RED-BREASTED SNIPE.

A common North American species, that has on a few occasions straggled to our shores. It resembles a sandpiper in its habits, and frequents the American coast in such large numbers that from sixty to eighty have been killed at one discharge from a large shoulder gun. It may be readily known by its possessing only twelve tail-feathers, and by having the under parts in summer as red as a Knot or a Godwit at the same season.

SNIPE-SHOOTING EPISODES.

The west of Ireland is by far the best part of our islands for snipe shooting. Snipe are more numerous, and consequently larger bags are made of these birds, in the counties of Kerry, Clare, Mayo, and Cork than elsewhere in the United Kingdom. Some thirty or forty years ago Norfolk, and other eastern counties of England, afforded nearly as good sport as Ireland does now, or lately did, but the drainage of the English fens has interfered greatly with the snipe shooter's sport.

The following instances may be given as examples of snipe shooting in Ireland. Patrick Halloran, a well-known snipe shot in the county Clare, on unpreserved ground bagged

in the season 1880-81, 1,400 cock and snipe, the heaviest bag of snipe in a day being forty-five. The number of cock killed was 138, half a dozen duck, and 1,376 snipe. We have before us his record of birds killed day by day and the receipts for the same when sold, both of which correspond.

The far west of Kerry is at this day famed in good seasons for snipe shooting. Within the past ten years fifty and even sixty couple in a day to one gun have, to our own knowledge, been obtained there.

Mr. Edward Gethin, of Earlsfield, county Sligo, who owns a large extent of snipe ground, enjoys at times first-rate sport. During nine days' shooting in 1873 he killed 360 snipe. During four days' shooting in 1874 he bagged 209 snipe, and so on with varying success to the present time.

His best bag of snipe, he states, was in 1877-78, when he obtained 959 of these birds.

Colonel Peyton, before alluded to, shot to his own gun on December 11, 1871, 102 snipe, besides wild duck, teal, and plover, on Lord Ventry's property near Dingle, county Kerry. He also shot, in December 1878, 265 snipe in five days' shooting, and the following year 241 in the same number of days. From time to time he has rented in Kerry 50,000 acres of snipe ground in a season. His bag in 1884, in seven weeks' shooting, consisted of 598 snipe, and 161 woodcock, besides various kinds of wildfowl.

The Hon. E. de Moleyns killed a few years ago in ten days, shooting on the property of his brother (Lord Ventry) near Dingle, 363 snipe. On March 9, 1866, he fired thirty-one shots at snipe and bagged twenty-seven of them. On January 28, 1867, he killed ninety-seven snipe between 10 A.M. and 3.15 P.M., shooting twenty-two couple in the first two hours; and in February of the same year he closed the season with a bag of 105 snipe to his own gun.

In 1880 Captain R. Denny, a noted snipe shot, obtained in county Kerry 681 snipe in nine weeks, besides a large number of duck, geese, and plover.

Mr. Lloyd, the author whom we have before quoted, writing in the 'Sporting Magazine' for September 1847 says:—

'Taken altogether, my best season in Ireland was in 1820. I commenced on December 5, finished towards the end of March,' and included, among other wildfowl, 414 cock and 1,310 snipe.

One game-dealer in Ireland, for whose accuracy we can vouch, and whose daily accounts of game we were allowed to inspect, purchased from the peasantry around Tralee, county Kerry, in the severe winter of 1880-81, 9,264 snipe among many other birds, such as cock and plover. The largest number of snipe received by him in a day was on January 4, 1881, when 856 were purchased. The total list of wildfowl sent over to the English markets that season by him was 16,733.

The Norfolk fens, before they were so extensively drained some forty years ago, afforded splendid snipe-shooting. Those near Hickling, and others in the vicinity of Buckenham, were considered to be the best. It was in this county that a celebrated and oft-quoted bag of 158 snipe in a day was made by Mr. R. Fellowes.

In 1860 Lord Leicester killed over seventy couple in a day near Holkham, in Norfolk, and on the following day his lordship and a gamekeeper bagged seventy-eight couple. This was owing to a large flight of snipe having suddenly appeared. Messrs. Gurney and Fisher, in their 'Account of the Birds found in Norfolk,' published in 'The Zoologist' for 1846, state that on December 11, 1844, 500 snipe were brought for sale to one dealer alone in Yarmouth, and on December 16, 300 snipe.

In reply to inquiries as to Norfolk snipe-shooting, the following letter from Colonel Leathes, who owns much snipe ground, and is, besides, very fond of this sport and of duck decoying, may be of interest. He says:—

You ask me about snipe. The best snipe manor I know of is 'Whitecast,' near Lowestoft, on Oulton Broad. Whitecast

proper is only fifty acres—rather less, I think—but the marshes that go with it consist of about a hundred and eighty acres.

On Whitecast this bet has been won—viz that if you sift three square feet of ground one spade deep (provided it is not on the rotten land) you will find three ounces of shot, dig where you will. The fact is : Fifty acres of this land has been shot over backwards and forwards for ages, and the whole surface of the ground is covered with shot. I know this bet was made and won.

Snipe are also abundant in parts of Scotland. For instance, on the island of 'Terea' (one of the Hebrides), Mr. Mottram killed to his own gun 992 snipe in 1884-5 by the end of October, and in 1885-6 as many as 642 by the same time. (For other notes of snipe-shooting in Scotland, see Sir Frederick Milbank's records of sport in Lewis and Harris, p. 126.)

At Blenheim, the Duke of Marlborough's residence in Oxfordshire, some very good bags of snipe have been obtained. The upper end of the lake at Blenheim is marshy, and when the water is low, large numbers of snipe come in, and can scarcely be driven away by shooting.

For example, the following bags have been obtained at Blenheim:—in one day (1878), 42½ couple; in one day (1880), 36 couple. In December 1882, the Duke of Roxburghe and the Hon. Edward Marjoribanks shot 48½ couple in a day, and on another occasion in December 1883, the same guns, together with Lord Walsingham, bagged 53 couple of snipe in a day.

But for big bags of snipe India must claim precedence over every other country. We have seen more snipe shot in India in one season than in three seasons anywhere else, including even Albania and Dalmatia, where they are, during some winters, so abundant.

As a proof of this Colonel Peyton writes to us as follows:—

In India I have *frequently* killed between eighty and ninety couple of snipe before mid-day, in the marshes on the banks of the Cabul river, where it debouches from the hills before entering the Peshawur valley.

SNIPE SHOOTING.

This subject is indeed a puzzler. We could as well fancy one hunting man telling another how to go through a run the next day, where to find a fox, how and where to ride, and the hour to turn homewards. However, something must be said on the subject, as much to the point as possible. The fact is snipe-shooting is more or less a 'toss up'—that is the beauty of it, there is no regular rule to go by. It has all the uncertainty of cock-shooting, and perhaps more besides. You may find many birds; you may find none. They may lie well, every one; or they may every one rise just out of shot; or they may rise one shot and a half off—a constant trick of theirs. You may hit them in fine style, or you may miss four out of five. There is so much that is unaccountable in shooting snipe, and good or bad sport with them is such a lottery, that at length it becomes a charm, and there is—well, an element of gambling in it. One shooter says, 'Walk down wind'; another advises 'up wind.' Some folks argue, 'Shoot a snipe directly he rises'; others advise you to wait 'and take your time.' Yet our little friend flies through all laws and advice with room and to spare. There is something wonderfully provoking, and also exciting, in the careless hither-and-thither flight of a snipe; something that, we won't say unnerves a shooter, but hurries his gun to his shoulder in a way that is not the case with any other bird save a cock, and is very conducive to the escape of a snipe. The very cry of a snipe is startling in its peculiarity.

Most people of experience agree that the only rule in shooting snipe is to walk down wind, on the principle that snipe, like other birds, rise against the wind, and that they then, for a few seconds, fly towards the shooter, or rather hang in the air, above the spot where they rise, before darting away. Besides this they are then liable to pass the shooter to his right or left within shot. If walking against the wind a snipe will nevertheless often dart off, and put many yards between

its tiny body and the sportsman ere the quickest of snap shots can pull the trigger. It should be borne in mind that a snipe is one of the fastest flying birds we have, and that, like a woodcock, its wings possess immense power in comparison to its size. As to going down wind on snipe, no doubt it should always be done if possible ; but how often is it possible? It has



Snipe rising.

often occurred to us that we have scarcely ever gone down wind on snipe throughout an entire day, owing to the irregularity of the ground. If snipe

were always found on ground that could be traversed in any direction for a mile, well and good.

In the opinion of some snipe shooters, walking against the wind, by reason of the birds lying better, balances any advantage which may be obtained by walking down wind. There is no doubt that snipe almost invariably rise with a zigzag motion, first one wing up, then the other, especially if there be a good breeze. They seem, indeed, to play with the wind as they spring up and fly off. There is also no doubt that they usually discontinue this zigzag flight after about a dozen yards, or even less. It is during these first few yards that they are most difficult to hit. Therefore, if a snipe rise in easy shot, give him a chance of a few yards with your

gun to the shoulder, sighting him meanwhile; just before getting out of shot the chances are he will soar away quite steadily, with a regular beat of the wings. Snipe rising within easy shot are oftener missed than at any other time, through the shooter firing too soon

If a snipe rises not too near, but at a good distance, though still within fair shot, you cannot be too quick to take him before he gets into a maze of twists. This is not a case of waiting, as he would be out of shot if you waited for two seconds. Snipe are very often missed from not being fired at soon enough when they rise at a fair distance.

The reason a snipe twists on rising is to conquer the wind, and bring his power of flight under command; afterwards he will go steadily away, though at a great pace.

Not one ordinary game shot in six makes a good snipe shot, and there is more of a knack in killing snipe than in any other bird. Nine out of ten snipe shooters—men who are devoted followers of the sport—rise to a certain pitch of excellence, killing the birds well some days, not so well others, but seldom improving their average. Then comes the tenth man, who kills in beautiful style his five out of seven snipe fired at from Monday to Saturday, and he neither knows himself nor does anybody else know the secret of his success.

Always aim *above* a snipe; the bird is pretty certain to be on the rise when going away, though you may not think so. In the same way, if crossing, aim well forward, or one beat of his powerful pinions will put him three yards ahead whilst the finger is pressing the trigger. Let 'forward and high' be an absolute rule when pulling on snipe.

If you begin a day's snipe shooting in bad style, missing easy shots you know not how, sight a couple or more without pulling trigger, and let fancy say, 'I could have knocked him over if I had liked.' The next snipe will probably be killed through restored confidence; at least, we have seen a man's shooting wonderfully improved, as our own has been, by acting this little innocent farce.

When walking on unsteady ground and expecting snipe to rise, many a shooter finds it hard to know where to look—whether at the spot where he expects to see the birds jump up or at the treacherous ground, underfoot. Endeavour to keep the eyes directed somewhere between both points, so as to command the shooting and the walking. If hesitating over every step, you cannot expect to kill snipe; if, on the other hand, you think of nothing but the birds, you will soon come to grief in soft ground, or make a half stumble just at the wrong moment. An accomplished 'bog-trotter' knows by touch whether the ground underfoot can be walked without much picking and choosing, and by instinct withdraws an over-step at once, where another man goes plunging on into difficulties. It is no use being tempted to follow snipe into quagmires; unsteadiness underfoot means missing bird after bird, and no wonder. When shooting snipe avoid splashing through water as much as possible; this bird is very apt to benefit by such a warning sound.

A shooter must subdue every particle of over-anxiety—we mean that 'jump of the gun' which is so hard at first to get rid of by those not used to snipe shooting. Until he learns this, and practises day after day to attain it, he will never achieve the coolness and readiness necessary for successful snipe shooting.

When snipe are about, and you have fired at a bird, load instantly, and as quickly as though a bird were on the wing within easy range. It is a frequent habit of snipe to jump up just as you are wondering why you missed, or admiring the way you killed with your last shot, and are, maybe, loading leisurely without looking at the gun. It is then a hurry with the cartridges and a scuffle of the fingers, followed by a miss.

The lighter the gun the better for shooting snipe, but we are strongly against small bores, such as twenties and sixteens, and so, indeed, are all the practised snipe shots with whom we are acquainted. They give too small a killing circle, and

12-bores are now made as light as the sixteens and twenties of a few years ago.

A heavy gun out snipe shooting handicaps a shooter severely, however powerful he may be. When balancing himself on a bit of rotten marsh, two or three pounds too much weight in one hand, in the shape of a heavy gun, gives him so much extra trouble to walk steadily. Besides, the whole secret of snipe shooting is in using a gun that can be handled like a stick, quickly, neatly, and lightly, and that has moreover a fairly large killing circle such as distinguishes a 12-bore.

A 12-bore gun weighing $6\frac{1}{4}$ lbs., with a charge of $2\frac{3}{4}$ drs. No. 6 Curtis and Harvey's powder and $\frac{7}{8}$ oz. of No. 8 shot, is, in our opinion, the best for snipe. Anything smaller than No. 8, such as No. 9 or No. 10, will wound and lose many birds that would otherwise have been bagged. It is a mistake to think that the least touch will bring a snipe down—it will not. Of course a pellet in a vital part, whether snipe or pheasant be the recipient, will cause death at once. But snipe will very often fly almost out of sight and then tower and fall dead. Snipe riddled about the wings and back with shot will fly a long way and pitch as though none the worse, though afterwards they may be picked up dead—if found. We have known snipe after being shot at with No. 10 fly across a lake apparently unhurt, but on searching the water by means of a boat have at the day's end retrieved a half-dozen along the lee shore, blown in by the wind.

Though the best shots at snipe kill a much larger average of birds than those less skilful at the sport, the latter may take consolation from the fact that now and then after a clean miss it was nobody's fault, neither man nor bird.

How often is it said after a miss, 'I cannot account for it; I covered the bird beautifully when firing'! But how seldom is it realised that with the best and closest shooting gun ever made, and loaded with No. 8 shot, a snipe can fly between the pattern made by the pellets at forty yards in several places and be scarcely touched!

It should be noted that a jack snipe is always worth powder and shot in a frost ; when other snipe are starved, a jack will be found as fat and as dainty a morsel as ever—a fact well proved but not quite accounted for. The best dog for use on snipe is a small Irish water spaniel.

R. P. G.

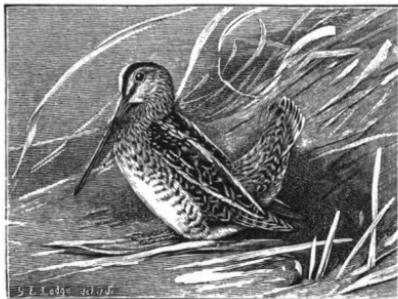

Snipe sitting.¹

¹ This illustration represents what I have constantly seen—a snipe always sits with his back to the wind.—ED.



Sir Ralph P. Gallwey in fowling costume.

CHAPTER VII.

WILDFOWL SHOOTING.

OF all amusements dear to a sportsman who loves to use a gun on wild birds in wild places, none is so absorbing as wild-fowl shooting. This is especially the case if the gunner is even slightly an observer of nature, and takes an interest in noting the habits and plumage of the numerous tribe of wildfowl he will have a chance of seeing and shooting during a fairly hard winter. Those severe seasons of frost and snow and bitter winds that now and then occur in England gladden a fowler's heart, and he goes out in what is to *him* favourable weather,

whilst other men are sighing over unexercised hunters, or putting by their guns in rack or case till fields and woods are, from their point of view, fit places for sport. A fowler well knows that the more severe a frost may be, and the more biting the north and east winds, the better it is for him, for then are his fowl to be found, and under such conditions will he do well to seek them.

Wildfowl generally come with a rush, and, what is more remarkable, go in a hurry too. Here to-day, gone—to-morrow knows whither—to-morrow.

The hunting man has his horses, the landlord his pheasants and partridges, the angler his river; their sport is more or less secure; they know where to seek it: but not so with the fowler.

All of a sudden, however, his chance appears. The oft-scanned thermometer falls to below freezing point; the weathercock veers round from south-west to due east; the opportunity has arrived and must be made the most of while it lasts.

Now against the murky snow-charged sky may occasionally be seen flying overland, in strings and bunches, duck and teal, or wedge-shaped skeins of wild geese; whilst at sea, and along the coast and flats, are vast packs of brent geese, calling in wonderful resemblance to hounds in full cry, as they fly restlessly hither and thither till at length they settle to feed in earnest on some isolated bank of ooze.

Widgeon, always most eagerly looked for by the fowler, are now to be seen off the shore, floating out at sea during calms, ever and anon rising in the far distance like a cloud from the horizon, only to sink again from view.

Inland, all still waters are frozen and bird-deserted, but not so the streams. Early in the morning the fowler steals along their rushy banks like a shadow, and is rewarded with many a duck while most folk are yet abed. Between late afternoon and dusk he anxiously awaits flighting, standing perchance sheltered among the fir trees with the chill wind whispering or perhaps roaring through their tops, watching, eyes and

ears strained, to catch the whistle of pinions, and to see in the too rapidly darkening night the streak, like a pencil line across the sky, that represents fowl travelling seventy miles an hour from the coast or meres to well-known and unfrozen feeding-grounds. In the daytime the coast fowler is busy enough, waiting on and following the companies of fowl, which he can see by means of his glass, feeding or sleeping on the flats, or paddling at sea. Presently, by a happy combination of time and judgment, he succeeds in getting a shot or two, and so one day follows another, till the frost breaks, the thaw sets in, the birds disperse—for they can now find food and water again on all sides—and the fowler lays by his long gun and white cap till fortune favours him once more. He alone of all sportsmen does not rejoice at the disappearance of frost.

A man to be a successful wildfowl shooter must delight in scenes and incidents that other shooters would shun. He must be sound in wind and limb, and in perfect health, or it will tell against him sooner or later. He must be possessed of great endurance, as well as of cool courage; able to grasp a dangerous situation in a moment, to act promptly and with discretion.

When shooting afloat, the motto of a wildfowler should be—never advance without securing a safe retreat, for a man's life is worth (to himself) the biggest company of ducks that ever swam.

What may be termed the backbone of wildfowl shooting is the study of the birds sought. Once learn something of their habits and natural haunts, and the rest comes easily. To most shooters a duck is a duck, and a wild goose a wild goose, but the successful fowler will tell you of a dozen species of the former, and half as many of the latter. Why? Because his experience, learnt by frequent failures, has taught him that almost all the fowl he obtains require to be sought in different ways, though a gun be the eventual means of securing them all. For this reason, we will begin with a short natural history

of the wildfowl usually seen or shot by a fowler, and at the same time point out those that are more rarely obtained.¹ Concise directions for the use of punts and swivel-guns will be given, as fowling afloat is the perfection of wildfowl shooting; it is, indeed, a science in itself, and one of which inland shooters are almost invariably ignorant.

Should any aspirant to this latter branch of the sport wish for further details than we have here space to give, or care to see the subject more fully explained by means of numerous sketches of bird life and fowling scenes, in all the phases of inland and coast shooting, he may be referred to Mr. Van Voorst, Paternoster Row, for a copy of 'The Fowler.'² As the swans and several of the wild geese, as well as other wild fowl, somewhat closely resemble one another, we give a few notes on their distinctive colouring and size that may be useful to young fowlers, in order to enable them the more readily to recognise the species. When a description of a bird is given in these pages it refers to the adult male should the female not be specially mentioned. The females may be said to closely resemble the males in form in most cases, though of duller plumage and smaller size; the young males and the females being very similar in appearance.

SWANS.

Swans are useless birds to the gunner, and scarcely worth following should they be seen. We have done some execution on swans, both sitting and flying, with a rook rifle, and have now and then taken a shot at them from a fowling punt with a swivel-gun. But we have always felt somewhat ashamed at slaying such majestic birds—birds, too, that are almost worthless

¹ The actual descriptions of the wildfowl herein may be thought to partake rather too much of the nature of a catalogue, but under the circumstances this cannot be avoided, that is to say if, as is intended, the descriptions are to be of practical service to young sportsmen, who should be naturalists as well as shooters.

² *The Fowler in Ireland*, by Sir Ralph Payne-Gallwey, Bart.

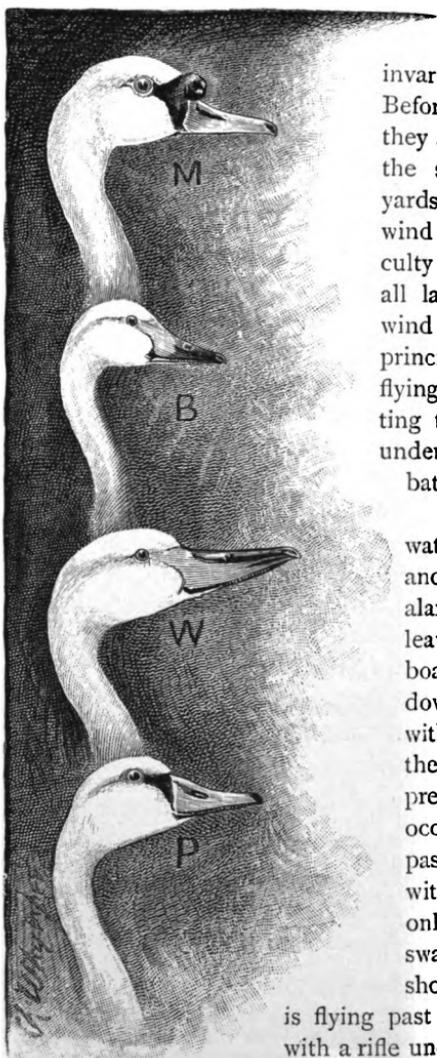

M. Muteswan. B. Bewick's swan. W. Whooper. P. Polish swan.

when obtained. Swans rise very slowly, and invariably against the wind. Before they can quit the water they are forced to flap along the surface for a hundred yards or more. The less wind there is, the more difficulty they have in rising, for all large water-fowl use the wind on exactly the same principle as is evolved in flying a kite—that is, by getting the breeze against and under their wings as they battle against it.

When alarmed on the water swans crowd together and sound their note of alarm before preparing to leave. With a fast-sailing boat we have at times run down wind on swans to within thirty yards while they were hesitating and preparing to fly. On such occasions they are sure to pass above or alongside within easy shot. The only vulnerable part of a swan to aim at with a shoulder gun if the bird

is flying past is the head and neck, with a rifle under the wing. It is not much use trying to get near swans against the wind with a view to shoot-

ing them, as they will then fly away from the shooter without passing him as they would do if approached down wind.

On some occasions, after severe gales and snow, swans, when they first arrive, are absurdly tame, and may then be shot without difficulty. At such times they fly low over the land, as though seeking a suitable place whereon to alight and rest after their long and weary journey from the far north. In fine weather they fly with surpassing swiftness, though heavily, as if it was all they could do to keep their immense bulk afloat. They travel across the sky when at a good altitude as fast as a duck or widgeon, though their slowly-beating wings do not convey an impression of the great speed they really attain.

The cracking noise that is caused by the wings of a swan when beating calm water as he rises is very distinct at several hundred yards' distance, and the united efforts of a couple of hundred so rising, as we have now and then heard them, is extraordinary in its resemblance to the smashing of a great number of sticks.

Wild swans may be known at a distance by their stiff unbending necks, which they carry, like wild geese, straight and erect, and quite unlike the graceful curve seen in the tame species.

Swans are very uncertain in their visits to our islands, hard weather alone bringing them in large numbers. But when they do come they appear distinctly to remember the places at which they have passed their time years before, and these spots they are certain to revisit.

We have noticed that they fly when *en route* to old feeding-grounds over exactly the same trees and houses they passed when last seen, perhaps some three or four years previously. This was remarkably the case at one place well known to the writer. A mere, which the swans had visited off and on within the memory of man, was drained and ploughed. No swans had been to it, on account of mild weather, for some winters. Suddenly we had a term of frost and northerly gales. About sixty wild swans were seen flying towards their old haunts.

We followed, telescope in hand, and plainly saw the birds pitch in the centre of where the mere once was, gaze wonderingly around and wing away south in search of an undisturbed haven.

WHOOPER.

The whooper is largest of the genus, and easily known by its great size. The whole plumage of an adult bird is pure white. The young birds are of a grey appearance. Length, 5 feet; from tip to tip of extended wings, 7 feet 7 to 7 feet 10 inches, a very fine specimen reaching close on 8 feet. Ordinary weight, 18 to 22 lbs. We have weighed one that turned the scale at $24\frac{1}{4}$ lbs., and they have even been recorded of as great a weight as 28 lbs.

The whooper is a regular winter visitor to Scotland in considerable numbers, but is less numerous in England and Ireland. Small herds of from four or five to fifteen whoopers are occasionally to be seen during hard weather off the east coast of England, but seldom in the south and west.

BEWICK'S SWAN.

This is a much smaller species than the last, being only 3 feet 8 to 3 feet 10 inches long. Breadth of extended wings from 6 feet to 6 feet 3 inches. Weight usually about 10 lbs., but we have shot several of 12 lbs., others under 9 lbs. Plumage pure white; young birds grey.

The Bewick is not so common a swan in England and Scotland as the whooper; but in Ireland, in some localities, it is very numerous during hard weather.

We have seen fully two hundred together on an Irish estuary; and when severe frost sets in, they frequent one shallow lake we know in far larger numbers, nearly a thousand being there sometimes seen together.

Bewick's swan is a tamer bird than the whooper, it floats more buoyantly on the water, and looks quite a third smaller.

MUTE SWAN.

Length, 5 feet. This is the tame swan of our lakes and rivers, and is far more ornamental in shape than its wilder relations.

This swan may be at once known at any time and place by the large black knob on the base of the bill, the same part in the whooper being yellow with the knob much less developed. The presence of this knob may serve to save its life, as it may have escaped from a friend's grounds, or else have wandered from a neighbouring swannery. We speak of this bird as tame, though in reality it is semi-domesticated. It is found abundantly in a perfectly wild state in some parts of Europe and Asia.

POLISH SWAN.

Similar in size to the last. Naturalists have long disagreed about this bird, but they have finally decided to acknowledge it as a distinct species. Its chief peculiarity consists in its being pure white, both as a cygnet and an adult. All other swans are grey when immature. We know but little of its habits or breeding grounds, and its capture in Great Britain has not been recorded more than some score of times. It bears in certain stages of plumage a very close resemblance to the 'mute' species.

WILD GEESE.

The Brent goose is distinguished by having the bill, head, neck, breast, feet, and tail, sooty-black; on each side of the neck a patch of white with a few black feathers intermixed. In young birds this patch is less marked than in the older ones, and sometimes is scarcely discernible. The upper plumage is of a dirty slate, belly of a brownish grey, barred at the sides with greyish white, tail coverts white. Length, 21 inches. There is no perceptible difference in plumage between the

male and female of any wild goose, so far as we can discern. This is of all wild geese the most sought after, and the most interesting. It is also the smallest, being no larger than a shelduck, and scarcely so long as a mallard, though of greater bulk. It is far more numerous than any other species of wild goose that visits our shores.

Unlike other geese, the brent is never known to rest on dry land, but may be seen on banks of ooze washed by the tide. It is fond of paddling about at sea, or among rocks and islands in the salt water, picking up drifting weed. We have never seen and rarely even heard of this bird in fresh water, unless wounded, and so driven from the sea, as all wounded birds are wont to be to avoid the smart of salt water.

Personally, we never even saw brent geese fly over dry land. Their food consists of the sea grass (*Zostera maritima*), and it is therefore the presence or absence of this weed that keeps them, after their arrival, to one point of the coast, whilst on other portions they are never seen, save in the shape of a few stragglers.

Whatever the winter may be, severe or open, brent geese visit us in thousands, nor are they to be driven away by the persecution they get from the coast-gunners. The only effect of constant firing is to make them so wary that the most experienced fowler cannot get within long range of them. They are by nature, of all wild fowl, most on the alert. Very rarely are they to be seen sleeping, head tucked under wing, like the duck tribe or the land-feeding geese. Yet in some few conditions of weather and tide, though it be at long intervals, the coast-gunner will get a chance at brent.

If possible, always try for brent before and after a gale, when everything looks as black as it well can at sea, and there is a very low glass and increasing wind. You may then set out with punt and gun, and search wherever you can find a sheltered creek, somewhere near their usual feeding grounds. Just before sunset is the best chance of all, for after flying to and fro all

day, the birds are more settled in the evening for a feed, especially at about half flood-tide, when their food is being covered by the water every moment. Before a gale, too, they feed with redoubled energy, conscious of discomforts to come ; for no

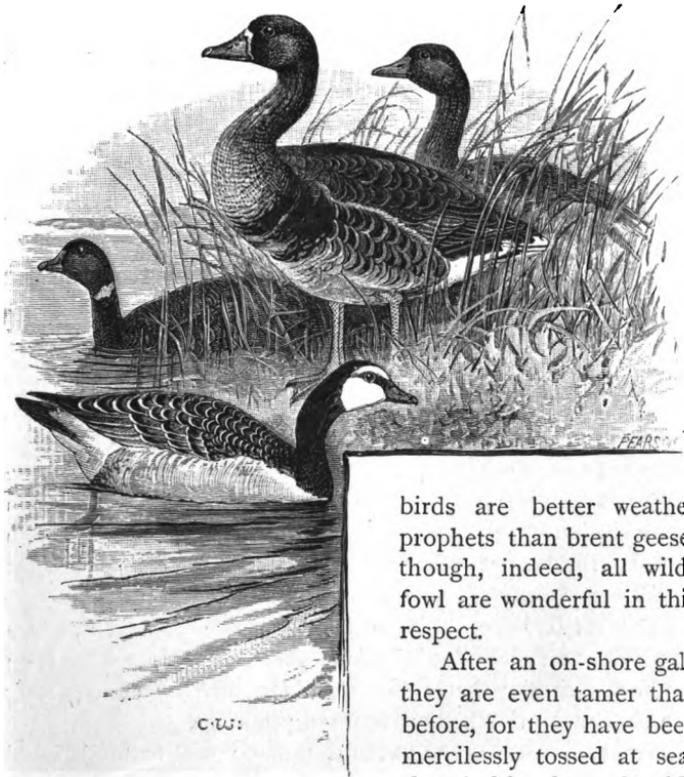

The White-fronted, Bean, Brent, and
Bernacle geese.

birds are better weather prophets than brent geese, though, indeed, all wild-fowl are wonderful in this respect.

After an on-shore gale they are even tamer than before, for they have been mercilessly tossed at sea; the wind has kept the tide from exposing their feeding grounds as usual, and the

birds are anxious to make up for lost time.

Brent seldom pass the night in a harbour or estuary, and then only in weather of the worst kind, so bad that a punt-gunner could scarcely guide his craft on a pond, much less shoot in a

creek or bay. The calmer it is the further they fly out to sea, to rest by day or sleep by night.

The milder the weather the harder it is to get on even terms with brent geese, and at all times they are more or less difficult of approach; though in continued hard frost they become tame, through their feeding grounds being frozen directly the latter are exposed by the ebbing tide. In the far north of Europe, where, in some places we have visited a gun had hardly ever been fired at brent, we have found them as wary as anywhere else, and though they were daily before us in thousands, we never got a good shot at them, taking into account their numbers and other circumstances in our favour.

It is this goose, and not the bernacle, about which all the foolish stories were written by old chroniclers—how, for instance, it was generated at sea on floating timber from barnacles, its essentially marine habits engendering this belief—a notion, as we happen to know, still adhered to by some of the fishermen and fowlers of Ireland and Holland.

From forty to fifty brent geese have been obtained off the Irish coast at one shot from a swivel-gun, and we have seen them so densely packed, that, could we have got well within shot, a hundred would have been our bag; but we always just failed in our chance, so much are these birds on the alert.

Colonel Hawker tells us that he once bagged nearly a hundred at a shot with his large double gun, and we have it on the best authority that another gunner once killed over sixty at a shot in Scotland, some score of years ago.

Mr. E. T. Booth, one of the most successful naturalists and wildfowl shooters of the day, remarks, in the catalogue of his admirably formed museum at Brighton, that, some seasons ago, 1,800 brent were bagged in six weeks by one punt gunner off the coast of Ross-shire, and that frequently twenty or thirty, and now and then fifty, have fallen at a single shot, to his knowledge, on the eastern and southern coasts of Scotland.

Brent geese appear off the coasts of our islands about

November 20, and begin to leave at the end of March, though many may be seen nearly a month later, if the weather be fine and winds adverse to their migration northwards. Their call is a short hoarse cough, inexpressibly wild when many hundreds, perhaps thousands, collect together. They almost invariably call whilst on the wing.

Brent, in contradistinction to the habit of most wildfowl, feed almost entirely by day. Though in a wild state they are of all fowl the shyest, when kept on ornamental waters and fed daily they soon become the tamest and most docile. Brent geese breed on both shores of Nova Zembla, and Sir H. Gore-Booth, as well as Sir H. Boynton, have described to us from personal observation how helpless and tame these geese are in the nesting season, when unable to fly. They are usually termed on the coast 'black geese,' and they frequent nearly all parts of the coast of the British Islands, but are most numerous on the south-east of England, the east of Scotland, and the west of Ireland.

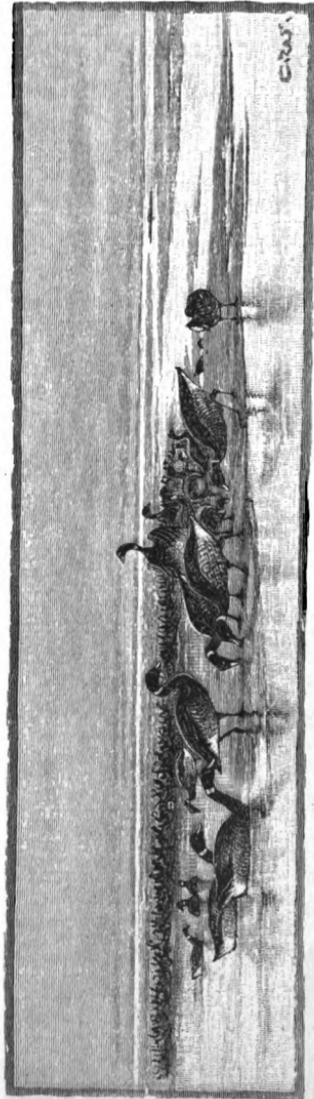

A shot at Brent.

When shooting brent or other geese from a fowling punt, beware of the fatal error of going directly down wind to them. If you do, they will never let you approach within shot; and do not get the wind straight from them to you, or when they rise they will head the wind and fly away from you. The best way is to go across the wind, and then you can take the birds as they rise against it.

Let it be remembered that a young brent is delicious eating, if kept from ten days to a fortnight.

BERNACLE GOOSE.

This wild goose should come next to the brent, as being closely allied to it in size and habits, though not nearly so well known or so numerous as a species. Forehead, sides of head, and chin, white; a dark patch from eye to bill. Head, neck, upper part of breast and tail, black. Belly, white shaded with grey; upper plumage and back, ash-grey and dull-white. Bill and feet, black. Length, 24 to 26 inches. Bernacle not seldom feed inland, and may then be seen on meadows and grain fields, but they especially seek marshes near the sea, chiefly those that are covered only by spring tides. This bird is rather larger than the brent, but is small for a wild goose when compared with the greylag, the white-fronted, or the bean goose.

Bernacle are very fond of paddling along shore, both at high and low water, picking up whatever they come across in the shape of food. We have often seen them feeding on the short sweet grass of the small low islands that at many places fringe the coast where it is low and marshy.

In Ireland the true bernacle, of which we now write, and the brent, are called the land and water bernacle; the one invariably feeding on or about the tide, the other on the borders of the sea, and, though close by, keeping apart. A bernacle can always be distinguished from a brent by its white face: in the brent the white is on the neck.

The bernacle is never numerous, but frequents the west coast of Scotland more than elsewhere. A few 'gaggles' are seen on our east and west coasts every winter, but seldom in the south. Bernacle, though not, like the brent, always found on the coast, are more usually seen thereon than inland, and when ashore have a habit of remaining, so to speak, within sight of the tide. To see them far inland, as we see the grey geese, is unusual.

In Ireland bernacle are fairly numerous, and we have several times observed from fifty to a hundred together, but they are everywhere very local in their habits, coming year after year to the same localities, and seldom choosing fresh ones. They are not so wild as the brent; a fowler has more chance of a shot at bernacle than at the former species, for bernacle do not always surround themselves by salt water or broad shelterless ooze, but sometimes rest in approachable places on dry land.

BEAN GOOSE.

The Bean goose, together with the three following species, from their prevailing colour, are known to fowlers as 'grey geese.' This and other peculiarities of form and habit distinguish them as a class from the brent and bernacle, the latter being commonly known as 'black geese.'

The bean goose has the bill, orange; the base and tip, black. Legs, orange. Upper plumage, brown ash; under plumage, dirty white; behind, towards tail, pure white. The folded wings exceed the tail in length. Length, 2 feet 6 inches.

This species has been popularly supposed to derive its name from the small knob or nail at the end of the bill, which is black, and somewhat resembles a horse-bean. But a much more probable derivation of the name is the fact that, in former years, its appearance in autumn just coincided with the bean harvest. Years ago an immense tract of land was sown in the east of England with beans, which, when the shedding took

place, were scattered on the ground in such abundance as to tempt these geese, then the commonest in England, to collect in prodigious numbers.

According to Yarrell, the bean goose is the most numerous species, next to the brent, that visits our islands. In England this cannot now be said to be the case; the white-fronted and pink-footed being, in our experience, oftener seen and shot; but in some parts of England the bean goose is still common, notably in Norfolk and Lincolnshire.

Bean geese are especially abundant in Scotland, where they may be seen in large numbers, as many as five hundred in a 'skein' sometimes. They even become a pest to the farmers from the damage they do to young crops, marching like an army across a field, clearing all before them. In Ireland they are also very abundant, especially in the south and west.

These birds usually pass the day feeding and resting in the very centre of wide open fields and plains; they are then quite unapproachable by the sportsman who is armed with a shot gun; a rifle may be tried, but is not often successful. If their chosen quarters lie within some dozen miles of the sea, they will fly down at sunset to pass the night on the marshes, and even on the banks of ooze; but at daybreak, with loud calling, they wend their way inland. They are by no means difficult birds for the coast-gunner to get within shot of. He should mark the exact position they take up when they appear on the coast, which, if they do at all, they will do regularly every evening. They are pretty sure to frequent the highest portion of a sandbank or ooze-bed, at the spot that is last covered by the tide. If the shooter sets out with his punt and gun for a shot at them, he should choose the evening on which the tide permits him to steal up to the birds at dusk, and so take his chance just before the geese are themselves forced to leave by the encroaching water. Once afloat, they will be swimming in all directions in open order, and not worth a shot.

In a fog, or at night, all geese seem to lose their customary caution to a great degree. In foggy weather we have got many

a good shot at grey geese by putting on a linen overall and white cap, and with a heavy shoulder-gun walked right up to them, guided by the noise they made. But in such a case the fog must be so dense that they can scarcely be seen till almost within shot.

The bean, as well as the other grey geese named, can cut wet grass as if with a pair of scissors. The brent, on the other hand, does not require this power, as he tears up the weeds by the roots, throws away the dark upper part, which may be seen floating about in incredible quantities near where brent have been feeding, and eats the succulent white stalk.

Let anyone so inclined dissect a brent shot after feeding, and he will find that he is filled with little ribbon-like packets of sea grass (*Zostera maritima*), some nearly a foot long, all neatly folded as they were taken down.

If bean or other geese pass overhead, and you have a shoulder gun, aim under the wing. If they pass sideways, aim at and in front of the head. Geese will oftener come within shot if you stand motionless on first seeing them coming towards you, than if you crouch, however far away they be. The latter is a movement that makes all wild birds suspicious. Do not attempt to put up your gun at any wildfowl flying past till they are within shot; then act quickly. If you handle your gun to the 'ready' just as they are getting nicely in range, the motion will sheer them off from coming within easy shot, as they might have done had you remained motionless till the moment of firing.

In fine weather bean geese are especially hard to approach within range, either on land or water, and anyone who has a few times endeavoured to steal a march on them will fully realise the phrase 'a wild-geese chase.'

This goose—indeed, all geese save the brent and bernacle—fly in the well-known wedge-like form. If only in small numbers, five or six for instance, they fly one behind the other, as close as beads on a string. In calm weather they travel

at an immense height, and though their 'honck! honck!' sounds distinct and near, yet their position cannot be detected without a keen search skyward.

The flight of all the grey geese is remarkable for its ease and regularity. Their wings scarcely seem to beat with a stroke of more than a few inches.

GREYLAG GOOSE.

This is the largest species of wild goose likely to be met with by a fowler. It is, comparatively speaking, a rare bird in England and Ireland, but of frequent occurrence in Scotland, where it nests annually in considerable numbers. It formerly also nested numerously in the east of England, but continued drainage has driven it from its haunts in the Fens.

The folded wings do not in this species reach the extremity of the tail. Bill, pale pink; nail, white; legs, flesh colour; upper plumage, brown ash; under plumage, in front ash-grey, towards the tail white; sides and thighs, ash grey streaked and barred with brown and white. Length, 2 feet 9 inches to 2 feet 11 inches.

It will be seen by this description what marked differences there are between this species and the other grey geese. The greylag is also larger, so that it is easy to distinguish it from others of its congeners.

It is this goose that has commonly been considered to be the ancestor of our domestic species, but doubts have of late arisen as to the truth of this statement, many naturalists considering that the 'white-fronted' has more resemblance and more claim to be so regarded. The greylag is the only wild goose that is resident and breeds in our islands.

At Castle Coole in Ireland (Lord Belmore's), there were in 1885 over a hundred greylag geese on the lake in the park. They never stray far, and no one knows how many years they have bred and existed on this water. They are undoubtedly true greylag, and exactly correspond in plumage and measure-

ment with the wild species. All geese, wild and tame, live to a great age. Many instances are on record of the latter, when in a captive state, attaining the age of a score years, and they are said to live to twice that age.

WHITE-FRONTED GOOSE.

The folded wings reach, and sometimes slightly exceed, the length of the tail; legs, orange; bill, flesh colour; nail, white (like the greylag); under plumage on the breast, shaded white, with transverse bars and patches of black; upper plumage, ash-brown; a large space at the base of the bill and round the forehead pure white, bordered by a dark shaded band towards the head; length, 2 feet 3 inches. The distinctive mark by which this goose may be known is the white band on the forehead; hence its name, 'white-fronted' (*Alba Frons*). This feature is always discernible, while the handsome tortoiseshell colouring on the breast is chiefly borne by old birds.

It is in the white forehead of this bird that it bears so close a resemblance to our tame species, and it is for this reason supposed by many to be its ancestor. Like the rest of the grey geese it is an inland feeder, yet we have much oftener seen and shot it on marshy land than any of the other three species to which it is so nearly related. Of all wild geese this and the bean are the only two we ever saw associated in a wild state and feeding together. Though a regular visitor to England, it is not nearly so abundant as it was some twenty years ago. In Scotland it is, however, more numerous and regular in its appearance, and in Ireland it is the commonest of any of its species, except the coast-feeding brent; but it is much more numerous in the north of that country than in the south. According to our experience in shooting, it is not nearly so vigilant a bird as the greylag or bean species, and resembles the bernacle in not always choosing such hopelessly open ground to feed on. It is, in fact, somewhat similar to the bernacle in its choice of haunts, though not quite so partial

to the seacoast. It is oftener shot by coast men than are any of its fellows among the grey geese.

PINK-FOOTED GOOSE.

The folded wings do not overlap the tail ; bill, pink ; nail and base, black ; feet, pink, and tinged vermilion ; neck and head, rusty brown ; plumage, generally ash-grey, fawn colour, and white. The colour of the legs and bill of this goose is quite enough to determine its species, no other species having both bill and legs of so decided a pink colour.

This is another regular visitor to England and Scotland, and in the north-east of England is much more numerous than had been supposed till quite lately, as many wild geese, on being examined by naturalists, proved to be of this species, and not the bean, as had hitherto been taken for granted by shooters. This is remarkably the case on the Norfolk coast near Wells, as well as on the Yorkshire wolds, where wild geese are, in parts, very numerous. Here they fly down to the Humber to rest by night, where great execution is sometimes done among them by the punt gunners. We have known these men to obtain a score and more at a shot, near the junction of the Ouse and Trent, the birds invariably being pink-footed geese.

Like the bernacle and white-fronted species, the pink-footed goose has a liking for the tide, though it is an inland feeder. On the other hand, the greylag will remain, during its sojourn with us, in one haunt, and that usually an inland one.

The *Canada* and *Egyptian Geese*, as well perhaps as the *Spur-winged Goose*, are so frequently kept upon ornamental waters, from which they stray away, that they are hardly to be included amongst British wild geese ; while the *Redbreasted* and *Snow Geese* occur so very rarely as stragglers to this country, that it is scarcely necessary to do more than mention them.



Surface-feeding Ducks.

CHAPTER VIII.

SURFACE-FEEDING DUCKS.

Ducks may be divided into two well-defined and distinct classes—namely, the surface-feeding species, or those that *never* dive to obtain food further than they can reach without entirely submerging their bodies; and the diving ducks, or those that *do* dive to procure food from the bottom of the water.

Among the former class are the common wild duck, the widgeon, teal, garganey, pintail, shoveller, gadwall, and shel-drake. Among the latter are the pochard, tufted duck, golden eye, scaup, and the three species of scoter. There are a few others not here named, but they are so rarely seen that it seems unnecessary to describe them. Their names will be mentioned however when we come to the description of species.

Apart from their plumage and shape, the diving ducks may be recognised from the surface-feeding ducks by having a broadly webbed hind toe, which is of great assistance to them when diving and swimming.

The surface-feeding ducks usually spend most of their time on fresh water, such as lakes, rivers, and quiet, undisturbed pools. The widgeon is, however, a notable exception, as this bird is rarely seen in numbers, save on the coast. It takes much delight in tidal waters and banks of ocze, and is essentially a shore bird. In hard frosts the surface ducks are driven to the coast to obtain the food that is then denied them inland, where all is hard and frozen, both food and water. They are then to be seen in company with widgeon. In very strong winds these birds will sometimes appear very numerous on fresh waters that lie near the coast, being driven thereto for shelter from a tossing sea.

Diving ducks, especially the scaup and pochard, are very fond of tidal estuaries, the former being seldom found on fresh waters, and then only solitary, or at most a couple or two. The pochard is frequently seen on fresh waters, and far inland; so is the golden eye and tufted duck, the common scoter on rare occasions.

SHELDRAKE.

This is a very handsome duck, vividly marked in contrasts of chestnut, black, and white. The bill is red, with a protuberance at the base, also red. Feet, bright red. A broad band of chestnut nearly covers the breast, and reaches to each shoulder. Head and neck, shining black, tinted with green. Length, 21 inches. The female bird is somewhat less bright in colour than the male, and lacks the knob at the base of the bill. When seen at a short distance on the water, the sheldrake presents a purely black and white appearance; it is only on a close approach that the chestnut colouring can be distinguished. They are useless birds for the table, as their flesh is rank and unpalatable. They however make capital pets for

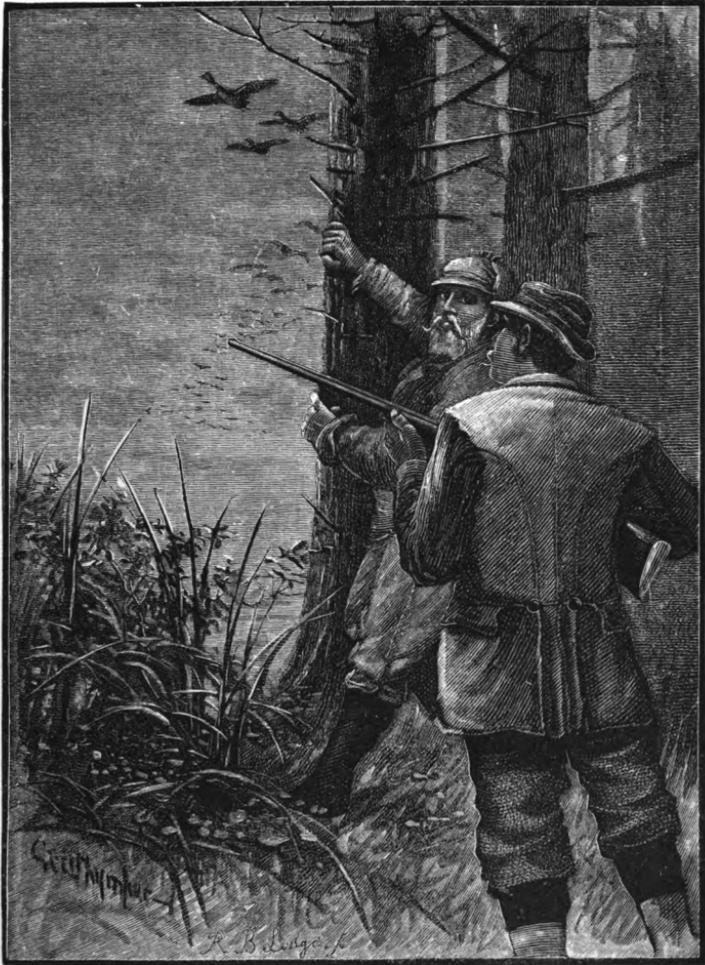

'HRRR THEY COME'

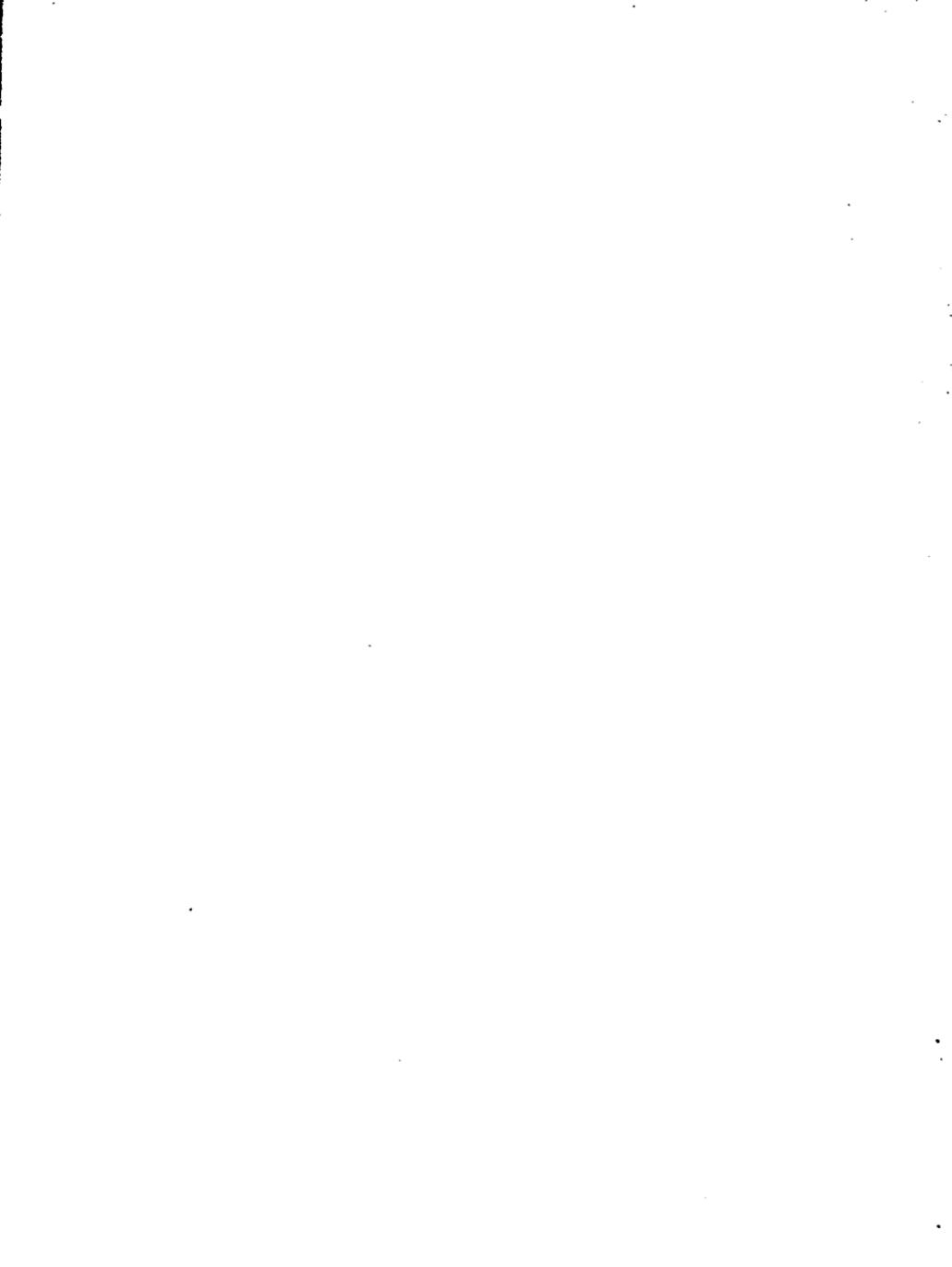

ornamental waters, and have been known to breed in confinement. They derive their name from the word '*sheld*,' signifying pied or parti-coloured, hence the titles 'shelduck' or 'sheldrake' are very appropriately bestowed. The mallards of the golden eye and red-breasted merganser, also parti-coloured birds, are sometimes locally called shelducks, evidently from this same appearance of black and white. Shelducks nest in many parts of the British Islands, nearly always in sand hills; they either use deserted rabbit-holes or burrow for themselves when about to lay their eggs. We have seen them fly into their excavations, closing their wings just when on the point of entering, so that they may avoid walking in and thus leaving a trace of footprints in the sand outside, as a guide to plunderers. When the young are hatched, the mother bird leads them straight to the tide after they make their first appearance outside their home—perhaps eight feet underground—but it is probable that she keeps them in the nest for the first few days. We have seen a shelduck, when the tide was low, and she was unable to lead her brood to the sea, carry them on her back, each duckling holding on by a feather, having, while she lay down, climbed up and ensconced themselves with the greatest care.

In parts of North Holland the natives trade considerably in the eggs of the shelduck as a source of food. They even form artificial earths, for this bird to lay in, running parallel with the surface a few inches underground; at the end of and above the tunnel so formed they cut a hole downwards, and place a slate to shut out rain. They then take the eggs from the shelduck as she lays them, using them as food, but always leaving one in the nest. The shelducks are not, of course, allowed to be killed, and many times have they disappointed us of a shot by mixing with large numbers of other fowl, so that to fire at the mass would have proved fatal to some of the protected egg-supplying birds.

There is another species of this duck, known as the '*ruddy sheldrake*,' but as it has not been shot in our islands in a wild state more than a dozen times, it need not be referred to further.

It may be seen on most private and public waters where wild-fowl are kept, and is a striking looking bird, of ruddy appearance and larger than its more common relation. In the shelduck the male and female are nearly the same in colouring, and in this respect resemble the goose tribe. It is not regarded as a true duck by naturalists, but somewhat of a connecting link between goose and duck. Its flight is very similar to that of a wild goose in the slow and even beat of the wings.

WILD DUCK.

The male is properly known as a 'mallard,' the female as a 'duck' or 'wild duck.' The name 'mallard' is, however, applied to male and female indiscriminately on many parts of the coast, whilst, inland, the term 'wild duck' is usually applied to either male or female.

This, like several of the species that follow, is too well known to need any description as to colour or shape. A good, well-fed mallard will weigh as much as 3 lbs., or even more. It is only the full plumaged or older males that exhibit the feathers which are so useful in fly-making, and may be seen in nearly all salmon flies. Not more than half a dozen good feathers are obtained from each bird.

The wild duck is the duck above all others that falls to the share of the inland shooter. Its great delight is to paddle and feed in fresh waters, such as lakes and streams; in this respect it resembles the teal. Wherever it is protected it will breed freely, and during the nesting season the male cannot be distinguished from the female in appearance, as both birds are then equally sober and grey in colour. The female moults gradually after the hatching season, and is never quite incapable of flight. The mallard, however, sheds all his quill feathers at once in July, and for about six weeks is quite unable to fly. He does not assume his handsome winter dress and become fully and finely clad before October.

If a shooter who lives inland is curious to know whether a

duck which he has just shot is fresh from the coast, let him examine the breast-feathers. Should the bird have rested on the sea (as they all do, unless home bred, when first they visit our shores) within a couple of days of its being obtained, a rusty yellow line—in fact, a high-water mark—will be observed across these feathers, a stain left by salt water foam and weed. After a few days in fresh water this mark disappears. It is only in severe frost that duck and mallard appear in numbers on the coast, when the decoy pools can no longer be kept free of ice,

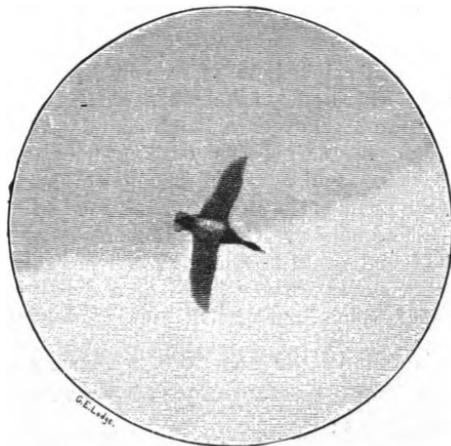

A Wild Duck on wing.

(From an instantaneous photograph by Lord Walsingham.)

and when all feeding grounds, such as wet meadows and marshes, are frozen. At such times the ducks first rest on the streams by day, whence they are soon frightened away by shooters. Though the birds are known to haunt fresh waters by night, they are off before daybreak, and do not return till after dark. During hard weather, on the coast, ducks become very wary. They will by day, and even by night, leave the ooze when nearly covered by the tide, as they are well aware that they are in danger of being shot by the punters if they remain till the tide

reaches them. The birds then fly either to the shelter of the decoys and large rivers, or out to sea till the flats are next uncovered, and they can feed again without danger. We have seen ducks when flying in from sea to a sheltered lake pass high overhead out of shot, and then drop like stones into their haven of safety, which may be some small pool in preserved ground. Yet, with all this, the common wild duck is the easiest of wildfowl to approach with a gun, except, perhaps, the teal. As an instance of how tame wild ducks will become, if unmolested, the following extract from a sporting journal will show :—

A very remarkable sight is to be seen at Monymusk, the residence of Sir Francis Grant, in Aberdeenshire. In a large duck-pond adjoining the stable-square, hundreds of wild ducks disport themselves in perfect security. They are not tame wild ducks, but *bonâ fide* wild ducks—wild wherever they go, yet tame the moment they settle in the pond. They swim up to be fed within a few feet of anyone, evincing no fear. Outside the precincts of their pond they are as wild as the wildest wild duck can possibly be. I have (says the writer) never seen or heard of a duckery like to this wonderful one, of which Sir Francis Grant is justly proud.

Sir Francis tells us the anecdote is literally true, as the reader will see from the accompanying letter written by him in reply to our inquiries :—

Monymusk, Aberdeenshire:
28th Nov., 1884.

In reply to your letter of yesterday, every word is perfectly true, and a gentleman is staying with me to-day who never saw the ducks in the stable-square before. He saw about 150, and the coachman called them and fed them with oats. Last Sunday I fed them, and they came to me within the length of my walking-stick. These winter evenings there are generally near 200 in the pond.

FRANCIS W. GRANT.

WIDGEON.

This bird is the mainstay of the coast fowlers, being far more abundant than any other species of duck that visits our

shores. It appears about October 12 in immense numbers off the north-east coast of Scotland, and gradually works its way south. By the middle of December widgeon are dispersed all over the shores of England and Ireland, and are by that time usually as abundant as they will be for the winter.

The widgeon has never been proved to nest in a wild state in England, though it is said to do so in Ireland. In the north of Scotland it breeds in a few favourite spots, which it visits yearly for the purpose, and tame birds in our possession nest freely in Yorkshire. The name 'Whew' is one of the oldest bestowed on the widgeon, which name the male bird exactly imitates when calling, pronouncing its note 'whē-ōh !' and with such shrill distinctness that it can be heard for half a mile on a calm night.

As before remarked, widgeon frequent the coast, and as a proof of this it may be noted that in the famous Ashby decoy in Lincolnshire, out of over 90,000 duck taken in thirty-five years, 2,000 only were widgeon.¹ Nevertheless, in decoys that lie close to the coast, naturally more widgeon are taken than any other bird. This is especially the case with the decoys that lie along the coast of Essex, as well as in others, which are also within a short distance of the tide.

Widgeon are very fond of assembling together, and will gather over a favourite bank of ooze in a dense pack, flying, swimming, and walking round and over it if feeding, or if sleeping they may be seen huddled together in one unbroken line. Then, of all other times, is the fowler's chance, if he can get near enough for a shot with his big gun. This he will probably find difficult to do on the ebb, with the water shallowing every moment, but on the flood it is the reverse, and this is the time and opportunity for which the fowler should wait and hope. The harder it blows the better it is for the widgeon

¹ For further particulars of this decoy, and of every other now or formerly in use in the United Kingdom, as well as particulars of the management and construction of decoys, the reader may be referred to the *Book of Duck-decoys*, by Sir R. Payne-Gallwey, Bart.; published by Mr. Van Voorst, Paternoster Row.

shooter, the tamer will the birds be, and so the easier to approach. In wild weather too the closer will they drift about the shore, and the more favourably will they be placed for the shooter on land.

Widgeon always predominate in a coast fowler's bag. Out of 1,500 duck and geese we once killed during a winter on the west coast of Ireland, no less than 1,200 were widgeon. Again, out of a bag of 500 duck which we obtained in the winter of 1883 in ten days, some 400 were of this species. These birds seldom fly aimlessly away when driven from their haunts by firing, but steer for some well-known though perchance very unsheltered aquatic resting-place. This locality a fowler should discover, and then follow them if he can, as, once there, they consider themselves fairly secure, and are consequently easier to approach within shot of should weather and tide prove suitable.

Widgeon, like other wild fowl, are much affected by bad weather, and without doubt rest and feed anxiously, though unguardedly, in anticipation of coming storms, thus affording another good chance to the fowler.

A few hours' lull in a three days' gale is a good time for a shot at widgeon, and well worth an outlay of time and trouble. We made a bag of 139 during a lull of a couple of hours in the terrific gale and snowstorm of January 18, 1881.

The best time of all for a shot at widgeon with a big gun from a fowling punt is at daybreak; an hour, even half an hour, at that time is often worth the rest of the day and night put together. The banks should be partly covered by the tide. The birds will have been feeding all night, and will have collected together, perhaps feeding still, on the ground covered with their favourite weed. They will be heavy and loth to take wing under these circumstances. Again, in the evening, when the banks begin to be uncovered by the ebb, the fowl will often fly to them from all quarters. But they will not gather thickly till the night has well set in, and then the fowler must wait for the flood in order to approach them, unless

they are placed along the edge of a creek, which is not too often the case.

A punt-gun shooter should also always endeavour to go out in a strong breeze in search of widgeon, as in heavy weather the birds, disliking the tossing waves, are very apt to pack on the verge of the ooze in order to rest and sleep. During spring tides this advice is especially applicable, as widgeon are then at low water usually a long distance from dry land, and so perhaps as they believe safe, and thus the more likely to rest on the banks, and afford good chances to the prowling gunner afloat in his punt.

When shooting by moonlight there is no possible chance of getting near fowl, save by coming from the shade towards them, with the moon before you, as you paddle to the birds. If you come down on them with the moon behind you, they will surely see you, and make off long before you are within shot. You might as well light up your punt with a lamp for their benefit. The same principle holds good in the morning—that is, you must paddle your punt towards the rising sun or brightening dawn; in the evening towards the setting sun, or in the direction of the glow left in the sky after sunset.

At such times, though in the gloom yourself and so nearly invisible, the fowl will appear sharply outlined against the light. The same rule applies when shooting fowl on shore with a shoulder gun.

On parts of the Scotch and Irish coasts widgeon are particularly abundant, and even in the south-east and south of England, during hard weather, they may be seen in large numbers. On the Irish and Dutch coasts we have many times knocked down from sixty to seventy at a shot, frequently from forty to fifty, and have more than once known from ninety to over a hundred to be obtained by a well-placed charge from a big gun.

About half a century ago, in the earlier days of Colonel Hawker, Southampton Water swarmed with widgeon, for nowhere are there more favourable feeding grounds than those

about Lymington and Hurst Castle. Now these parts are too much frequented by shooters, and a score birds at a shot is at the time of writing considered a good haul for a gunner.

Though widgeon are migratory birds, when they have once chosen a suitable feeding ground they remain near it, as a rule, throughout the winter ; other fowl may come and go in large numbers during severe weather to the same spot, but the company of widgeon that first took possession will probably not shift their quarters till they next migrate. If much persecuted they will float off their feeding grounds at dawn to a safe distance, and only come in to feed by night. With care and patience a coast gunner is sure to get a good rake at them sooner or later, but as the season advances the birds will become wilder daily, and it is more and more a waste of time to attempt to obtain them. For this reason a fowler should not frighten the birds for the sake of bagging a few, but should wait till he can insure his first shot being a good one, possibly the best of the season. Widgeon, like other surface ducks, seldom swim away from a fowling punt, but spring up and fly off at once on suspecting danger.

The male bird is very beautiful, but unless shot on fresh water where it has been resident for some time it cannot honestly be recommended for the table. Its flesh is always dark and strong when shot on the coast, and those folk who affect to relish it can have had but small experience of inland teal or wild duck. The widgeon breeds in the north of Europe and in Siberia, very late in the spring. Many widgeon frequent our shores as late as April before migrating north, yet as early as the beginning of September we have seen this duck with its full-grown young in large gatherings off the south coasts of Norway and Sweden, and on the north-west shores of Holland and Denmark.

THE AMERICAN WIDGEON.

A very rare species, that has been obtained but six or seven times in our islands. The head is a dull white, spotted with

black, with a green stripe behind the eye. In the female the entire head is speckled with black.

PINTAIL.

Another very handsome duck, excellent for the table, nearly as good as teal, and certainly more delicate in flavour than any other duck except teal. This bird is sometimes called the sea-pheasant, by reason of the great length of the two central tail-feathers of the male ; it has a white stripe down each side of the neck, and is 26 to 27 inches long, a greater measurement than that of any other wild duck, except possibly the long-tailed duck and the eider. The pintail is a very sprightly looking bird, and its long neck gives it a graceful appearance on the water. It is not an uncommon duck on our shores, but never so numerous as teal or widgeon. It occasionally breeds in Ireland, and, it is said, also in Scotland. We have on a few occasions seen as many as from three to five hundred pintails swimming together on Irish and Dutch estuaries.

GADWALL.

This bird, when seen at a short distance, bears a strong resemblance to a tame duck, indeed we have once or twice spared them in consequence of a doubt as to whether they were tame or wild birds we were about to shoot, till we were able to make out the distinguishing white speculum on the wing. But a near approach or an examination of a dead specimen soon shows the difference. The gadwall is a very thoroughbred-looking duck, most beautifully marked and dappled with grey, hence its local name, 'grey duck.' The breast feathers are covered with tiny, crescent-shaped pencillings. It is an extremely shy bird, and delights both in large fresh waters and in reed-grown pools. It is a rare duck in every part of our islands, save in Norfolk, in which county its abundance is the result of a pair of these birds caught in the South Acre Decoy that were pinioned and turned down on the lake at Narford,

where they bred freely and attracted many others, which also remained to nest on this lake.

The number of gadwall which frequent one private water alone in this county is computed at from fourteen to fifteen hundred birds. They originated as described some years ago, and have spread all over West Norfolk, wherever they could find shelter and protection and were allowed to breed freely, and are now as frequently seen on wing as any other species. They are purely wild in Norfolk, and this shows how one of the most beautiful and rare of our migratory ducks may be acclimatised in suitable localities.

In every other part of the British Islands it is extremely rare, and out of several thousand wildfowl which we have shot, we have only obtained a dozen or so. In Holland, however, this duck is numerous, and is justly considered a great delicacy.

SHOVELLER.

Another very handsomely plumaged duck, but its general contour is somewhat marred by the long shovel bill with its spoon-shaped end, from which it takes its name, and which tells its species at a glance. It is nowhere numerous on our shores, but may always be counted upon as an annual winter visitor. It nests sparingly in Ireland and Scotland, and freely in England, especially in Norfolk. The bill of a shoveller is fringed along the upper mandible with a pendant row of horny bristles, which act as a sieve when the bird is feeding, and serve to strain the water through, while the soft food is retained in the mouth. This bird no doubt sucks in with the water small insects and mollusca, the escape of which is prevented by the fringed mandibles, the fluid flowing in and out unchecked as the bird swims along in search of a fresh supply, its bill half in and half out of the water. The shoveller is very fond of ditches, ponds, and even stagnant pools; it is seldom seen at sea, and does not reach down in shallow water like the other

ducks for its food, its bill being admirably adapted to its manner of feeding.

Shovellers may be known on the water by their black and white appearance if males, and either sex by the long heavy bill. They also swim with the head and bill very low, especially when feeding or resting. They move lazily about the water, and are very easy to get within shot of. The eye of a shoveller is yellow, and shows in remarkable contrast to the plumage of the head.

TEAL.

Teal are the delight of a wildfowl shooter or decoyman, not only because of all ducks they are the best eating, but because they are so tame and unsuspecting in comparison to others of their kind. A fowler's face always brightens on perceiving a bunch of teal, especially if he has been unsuccessfully following widgeon or geese for some time past. He knows that with ordinary precautions the chances are in favour of a shot if he falls in with teal, while with extraordinary precautions the chances are often the other way when he is dealing with geese or widgeon.

If a number of teal are seen wheeling here and there, or even flying straight forward as if they had made up their minds not to alight or alter their course for miles, keep them carefully in view, and, without the least notice, with one downward sweep they may all of a sudden drop in order to alight. They are easy birds to stalk inland, as they are fond of stealing along under the bank of a river or the edge of a lake, and when once marked carefully down can usually be got on terms with by a careful stalk. This result is to be effected, not by stooping and crouching along the stream or water, but by invariably, if the ground permit, walking direct to the spot at which the birds were seen to alight. If they pitch on the edge of the water, and you are near the bank, retire landward, and when opposite their hiding-place walk straight for them. You then have a chance at them to the right or left, which you would not have if you walked

along shore, as they might have paddled forward, while if they swam towards you they would probably see you before you could discern them. This rule holds good in stalking all wild-fowl on rivers and inland waters.

Teal are about the earliest of the duck tribe to visit our islands. We have known them arrive in great numbers off the coast as early as September 20, but the small bunches of teal that may be seen during the beginning of September and end of August are doubtless home-bred birds. The fowler who is just paddling or stealing within shot of teal needs to keep finger on trigger and eyes well open, for no birds spring so quickly and with less warning than teal. They jump up from land or water as if shot skyward by a steel spring, scarcely raising their heads first. Widgeon, ducks, and geese invariably give more or less warning, if only for a few seconds, by stretching the neck to its full extent and looking alarmed.

An adult teal is one of the most daintily formed and beautifully plumaged of all its tribe. The male exhibits lovely contrasts of colour on the wing and head, but this perfect state of plumage is not attained till about Christmas. Teal are so lightly and delicately formed that a small blow will bring them down, and we have shot scores with No. 8 shot when seeking snipe, even up to a distance of forty yards. A flying shot at teal is an enviable chance to a fowler with his punt gun, if they are sufficiently numerous to tempt a shot. On the ground they sit so low and small that they are apt to escape the charge.

In the autumn of 1883 a number of teal frequented a bank of ooze; in company with a friend with whom we were shooting we watched them daily from the deck of our yacht, but we never considered them a good enough shot to follow with punt and big gun. We thought it wiser to leave them undisturbed till either they packed better for a shot, or attracted others; so we passed them by when in search of other wildfowl. At length they increased in numbers and fed fearlessly in a favourable situation. The punt was launched at them just at

the right moment of time, light, wind and tide. They rose out of range, flew high overhead, dipped down, and across the muzzle of the gun. One end of the string of birds doubled back and crossed the other. Just at that moment two pounds of No. 1 shot was sent flying amongst their crossing ranks, and eighty-five were picked up with scarce a cripple, all out of the water, clean and dry. This is quoted as an example of a good shot at teal; half a moment one way or the other, and instead of a first-rate shot it would have been a poor one, so



Teal's nest.

quick are teal in their flight and changes of position when on wing.

The best shot at teal in our experience was obtained off the Irish coast by our friend Mr. Vincent, who picked up 106 of these birds, the result of a flying shot with a big punt gun. The note of a male teal is a low piping whistle, that of the female bears a weak resemblance to the call of the wild duck.

GARGANEY.

This bird, sometimes called the garganey teal, or summer teal, is a little larger than a teal, though smaller than any other

species of duck. The distinctive mark by which to know a male garganey is the streak of white that commences between the eye and the base of the bill, and winds over each eye and down the neck. This pretty little duck visits us in early spring, on its way north. It is very seldom met with by the gunner, as it is not usually a winter visitor. A few nest in England every year, chiefly in Norfolk, about the Broads.

We lately saw a pair rise from a secluded pool on a Norfolk estate, where they have since nested. With the garganey we end the list of surface-feeding ducks.

R. P. G.

CHAPTER IX.

DIVING DUCKS.

WE now come to the diving ducks—that is, those ducks that dive deep down for their food, which lies at the bottom of the water. Of course, if the water be shallow, and they can reach their food without the necessity of going out of sight for it, they will act like surface ducks; but the latter, as before

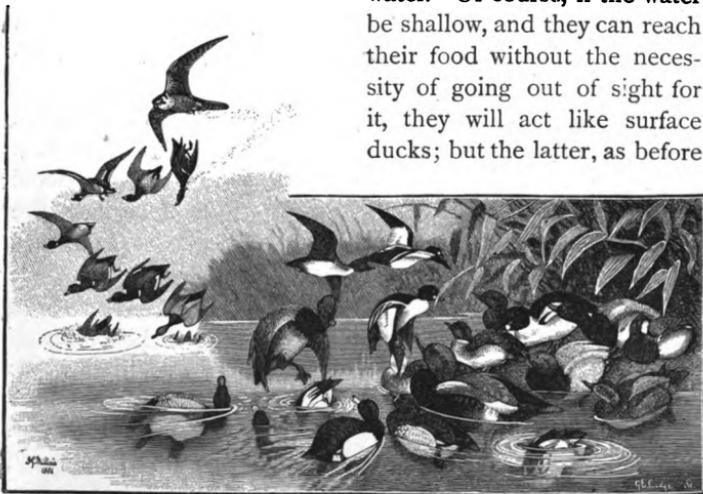

Hawk and Ducks.

pointed out, never entirely submerge their bodies when feeding. It is the constant habit of the ducks about to be described to submerge themselves entirely when seeking their food.

POCHARD.

This is a common duck in winter in every part of our islands, though of course much more abundant in some places than in others. It is seen in large numbers on the Scotch and Irish lochs and on the Norfolk Broads. It breeds both in England and Ireland in a few localities, but only sparingly. The pochard, from being so constantly followed, is on the coast one of the shyest of fowl. They are very rarely to be seen sleeping or resting, like duck, widgeon, or teal, but are always more or less on the alert, and the least movement alarms them. They then paddle quickly away, with heads turned round and eyes fixed on the object of suspicion. On inland waters, where pochard are protected and seldom frightened, they become tamer than any other fowl. We have known a pair that frequented a small pool and came up with the tame call-ducks to be fed daily. The pochard is closely allied to the canvas-back duck of America, and when killed on fresh water is of a delicate flavour, being scarcely less appreciated for the table than its larger cousin, where both occur. The pochard is locally known as 'the poker' or 'dunbird,' and also as 'the red-headed pochard,' or simply 'Redhead,' from the bright chestnut colour of its head and neck. This duck was formerly taken in vast numbers in the flight ponds of Essex and Suffolk. Some small pool near the coast which they frequented in great numbers (for no duck was so abundant years ago) was selected. The water was surrounded with huge nets, fastened between poles laid flat on the ground when ready for action, each net being perhaps sixty feet long and twenty feet deep. When all was ready, the pochards were frightened up off the water. Like all diving duck they are obliged to fly low for some distance, and also to head the wind before rising. Just as the mass of birds reached the side of the pool, one of the immense nets, previously regulated by weights and springs, rose upright as it was freed

from its fastenings by the fowler from a distance with a long rope. If this were done at the right moment, the ducks were met full in the face by a wall of net, and thrown helpless into a deep ditch dug at its foot for their reception.

RED-CRESTED POCHARD.

If a gunner is fortunate enough to obtain this duck, which at first sight resembles a large pochard, he will know it by its long, silky, chestnut crest. It also has the neck, breast, and abdomen a rich black (the latter in the common pochard is greyish white), the flanks being crossed with wavy lines. It is one of the rarest ducks that now and then visit our islands. Its appearance here has not been recorded a score times during the present century. We were most fortunate in procuring, just after it had been killed, the only specimen ever shot in Ireland (January 20, 1881).

FERRUGINOUS DUCK.

Another species allied to the pochard, of uncommon occurrence. It is a spring visitor, and is now and then shot on the east coast of England. It has appeared once or twice in Scotland, as well as in Ireland. It is a smaller bird than the common pochard, which it resembles, but may be known by having the back brown and marked with wavy lines, the back of the pochard being black and greyish white. It may be further distinguished by its white eye (hence the name 'white-eyed pochard' sometimes bestowed upon it), the eye of the ordinary pochard being bright red.

SCAUP.

Head and upper part of the neck, black, tinged with dark green; breast, black; back marked across with thin wavy black lines; bill, blue; abdomen, white; eyes, bright yellow. This is a very plump, round-shaped duck, of rather a heavy, thick-set appearance. It is one of the least tasty of all ducks

for the table, as well as one of the most provokingly cunning, and hard to shoot.

Scaup are essentially marine feeders, and seldom leave the salt water ; only now and then do they occur inland, after severe gales, and then but in scanty numbers, usually singly or in pairs. They are numerous on many parts of our coasts, and arrive with the pochard ; but, unlike the latter, they have never been known to breed with us. They are not much sought after by fowlers, as a small price is set on them by dealers in wild-fowl. They are sometimes termed ' mussel ducks,' from their habit of feeding on mussels and shellfish, which impart their coarse flavour.

Scaup are the most expert of divers, and a wounded one is a most difficult bird to retrieve, being, if possible, worse than a pochard in this respect. Off various parts of the coast we have often seen from one to three and four thousand scaup floating and feeding together, but, as above stated, they are valueless fowl, scarcely worth powder and shot.

TUFTED DUCK.

The feathers on the back of the head are elongated into a drooping crest. Head, breast, neck, and all the upper plumage, black, with green, bronze, and purple tints; under plumage, white. Length from 16 to 17 inches. This pretty little duck appears scattered all over our shores and inland waters about the end of October, and remains till the end of March. It nests freely in our islands, but is more partial to the lakes of Nottinghamshire and Norfolk than to any other parts of England. During hard winters tufted ducks may be seen in numbers, both on salt and fresh waters. On the latter these birds rarely gather together like other ducks, but scatter about the shore, diving for food. It appears a very small bird on the water, as indeed it is, and presents a black and white appearance. It is, in our opinion, the only diving duck, except the pochard, that is fit for food.

GOLDEN-EYE.

The adult male of this species is one of the handsomest ducks that swim, but is also, like the scaup, no good for the table. It may be known by a white patch or blotch under the eye. The head and neck are black, beautifully shaded with violet and green. All the under part is pure white. Feet, orange, with black webs. These ducks make a distinct and musical whistle with their wings when flying, and on this account are locally known as 'rattle-wings' or 'whistle-wings.' They are common to the shores and lochs of Ireland and Scotland, but are never numerous in England. In Ireland we have seen as many as a thousand young birds of this species together, without an old male. On the inland waters of Scotland and Ireland, however, we have seen as many as from thirty to fifty male birds together. The male golden-eye is of all wildfowl perhaps the most wary—never resting, always swimming, flying, and diving. Should a fowler pursue a number of young golden eyes, and one of the old magpie-plumaged males be with them, the latter will surely give the alarm, and take off the entire gathering in good time, long before they would have been in danger of being shot.

On the coast, the proportion of adult golden-eyes seen is very small, perhaps not more than one in forty or fifty. These old males seem to keep apart, and to frequent fresh waters. The ducks nest in holes of trees, and on one or two occasions have been said to breed in Scotland and Yorkshire.

BUFFEL-HEADED DUCK.

A very rare species in our islands, but common in North America. It has only been obtained in England some half-dozen times. It bears a strong resemblance in habits and appearance to the golden-eye, but is at least a third smaller. The patch of white on the head of the male bird is above the eye instead of below it, as in the golden-eye.

LONG-TAILED DUCK.

Head and neck white, with a large patch of dark chestnut on each side of head; the two central tail feathers much elongated, like the pintail; bill, black, with an orange-coloured band across it; length, including tail, 22 inches. The female has not the long tail-feathers. This is a common duck in the north of Scotland, but somewhat rare off the English coast. It is not unfrequent in the north of Ireland, and has been known to nest in Scotland. It arrives in October, and migrates northward about the end of March. It is a most accomplished diver, and we have always thought that those which we have shot have occupied far more time and trouble than they were worth. They are not good birds for the table, in consequence of their entirely marine habits. They do not seem to care in how rough a sea they remain. We have come across small parties of these ducks, chasing and playing with each other on the crests of the waves, fully thirty miles from land, in a gale of wind. They are loth to risk themselves along shore, and are never seen gathered on the banks, like widgeon or teal. They utter a wild musical cry, from which they derive their local name, 'calloo.' They are very graceful birds on the water, but very restless, constantly on the move, and hard to get within range of.

HARLEQUIN DUCK.

So called from the patchy appearance its plumage presents. It resembles the last described in its habits, but has only been obtained in our islands some nine or ten times, and is therefore too little known to say much about, for it is very improbable the fowler will ever come across a specimen.

STELLER'S WESTERN DUCK

has been twice obtained, once on the Norfolk coast, and again on that of Yorkshire.

EIDER DUCK.

Upper part of the head, velvet black ; lower part, greenish white ; neck and back, pure white ; lower plumage, black ; length, from 23 to 25 inches. This fine large duck never leaves the salt water, and is as sea-frequenting a bird as the gannet or Brent goose. It breeds abundantly in the north of Scotland, but it has not been known to nest further south than the Farne Islands off the Northumberland coast. It obtains its food entirely by diving, and spends all its time, when not nesting, on the water. It is not a migratory duck, as are others of its tribe, but passes its time in close proximity to the place where it was bred, so that only occasional specimens are seen on the south and west coasts of England and Ireland, on various parts of the coast of Scotland, or its islands. Eiders breed freely, and are well protected and encouraged as a source of profit ; their great nesting haunts are on the coasts of Norway and Sweden, and in Iceland.

The Eider is said to fly faster than any other of the duck tribe, different observers estimating its speed when in full flight at from ninety to a hundred miles an hour.

The King Eider is of such very rare occurrence in the British Islands that no particular description seems needed.

SCOTERS.

There are three species of scoters—the Common Scoter, the Velvet Scoter, and the rare Surf Scoter. All three revel in the sea, and are usually seen many miles from land.

The COMMON OR BLACK SCOTER is the smallest. This bird is of a deep, rich, black colour, without a speck of white or colour, save on the bill, which is bright orange with a black knob at the base ; length 18 inches. The young birds and females have a dull brown appearance. This scoter nests annually in small numbers in Caithness. It is one of the most numerous ducks on the east coast of England and Scotland, as well as on

the north-east coast of Ireland. We have seen immense gatherings of black scoters during early winter off the coasts of Lincolnshire and Norfolk and the south-east shore of Yorkshire. Scoters rarely visit fresh-water lakes except those which are close to the coast, and then chiefly in rough weather. They are difficult birds to get within shot of, nor do they offer favourable chances, as they usually swim in open order and seldom huddle together, as duck, widgeon, or teal do in hard weather. Scoters are also but little sought for, as they are proverbially of bad flavour, so much so that in Catholic countries their flesh is considered to be so fishy in taste that they are allowed to be used as food during Lent.

VELVET SCOTER.

Plumage of a rich velvety black; under each eye a white crescent-shaped spot; also a white patch on each wing. Bill, orange; nostrils, edge of mandibles, and lump at base of bill, black. The female is of a dirty brown colour with no yellow on the bill. Between the eye and base of bill a dull white spot, and another above the ear behind the eye; length, 23 inches. It is a regular winter visitor to the shores of England, though in small numbers; rare to the coast of Ireland, and much more common to the bays and estuaries of Scotland and its northern islands than elsewhere. In Orkney it is almost numerous at times. This scoter is perfectly at home at sea in all weathers. We have several times seen it during a gale fifty miles from land.

SURF SCOTER.

A smaller duck than the velvet scoter, but slightly larger than the common scoter. The plumage of this bird is without any white on the wing, but it may be at once known by a conspicuous white spot on the forehead and an elongated white patch down the back of the neck. The female is of a dull ash-brown colour, the white markings being shaded with grey;

length, 20 inches. This is by far the rarest of the three scoters, and is indeed one of our rarest ducks, it having occurred about a dozen times only in England and Scotland, and not more than twice in Ireland. It is a North American species, and probably only visits our shores during severe north-westerly gales.

MERGANSERS.

There are four species of these diving ducks—the goosander, the red-breasted merganser, the hooded merganser, and the smew. Any of the four birds of this class (genus *Mergus*) may be instantly known by the bill. They feed chiefly on fish (principally sand-eels), and the edges of the upper and under mandibles are, in consequence, furnished with small, sharp teeth, that point backwards for the purpose of holding their slippery prey. Hence the local name of 'saw-bill.' A pike's mouth is in its purpose and use very similar, on an exaggerated scale, to that of a merganser. All mergansers are quite uneatable.

THE GOOSANDER.

Head and crest black, the crest long and tinted with a rich metallic green; back, black; under parts, buff; bill, bright red, the ridge and tip black; feet and webs, vermilion; length, 25 to 28 inches. The female and young are of a much duller plumage; head and crest, brownish red; plumage generally, buff and dark ash; feet and bill, dull red. The goosander is not an uncommon winter visitor to the British Islands. It is frequently to be seen in Scotland, in some parts of which country it annually breeds in small numbers.

The appearance of goosanders off our coasts is much affected by weather; during mild winters they seldom appear. In hard weather they come in little bunches of from three to seven or eight, as well as in couples. After their arrival, they may be seen diving in the estuaries for food, as well as on lakes and rivers. They are most unwelcome visitors to a small trout stream, and

will catch in a week's sojourn probably as many trout as an angler would take in a year. The goosander is a fine, handsome bird, much the largest of its species, and when first killed exhibits a delicate shade of salmon colour on the breast and lower part of neck. But this colour after preservation rapidly fades to a dirty yellowish white which gives but a faint idea of the beauty of a recently killed specimen.

RED-BREASTED MERGANSER.

Head, neck, and crest, black, tinted with green. A deep white collar round the neck. Breast, reddish brown, speckled with black. On each shoulder, near the wing joint, are several large white spots edged with black. Back, black; under parts white, barred on the sides and underneath with wavy lines of grey; bill, dark, varied with vermilion red; feet, orange red; eye, crimson. As in the goosander, so in this bird, the delicate shade of salmon colour upon the breast of an adult male soon fades after preservation, and in a stuffed skin there is no trace of the colour that makes the bird so beautiful in life. Length, 22 inches. Female much smaller; head and crest of a brownish red; general plumage of an ash colour, varied with a dull mottled white; eye and bill, dull red; feet, dark brown, with a purple shade. The young male resembles the female in colouring, though it is of larger size. The crest of the male and female of this species is of considerable length, the outer feathers being nearly three inches long. In size it is next to the goosander, the largest of all. Adult males are very striking in their plumage, and far less common than females and immature birds, the latter being almost identical in appearance.

The red-breasted merganser is numerous in Scotland and Ireland, but is to be seen in small numbers only in England. In the two former countries it nests annually in considerable numbers, both on the islands in the lakes, as well as on those that lie off the coast. On the south-east and east coasts of Ireland and about the northern shores of Scotland and the

Shetland Islands these mergansers are particularly abundant ; as many as from four to six hundred occasionally being seen swimming together. Their favourite habit is to drift with the tide, feeding as they go, to a certain point, from which they will rise and start afresh. Of all the wary fowl that swim none is more shy than the red-breasted merganser. It is a very beautiful and interesting bird, though worthless for food.

HOODED MERGANSER.

Upper part of the head and neck, black. On each side of the head, above the eyes, is a fan-shaped crest, the small end and lower portion of which is white. The fringe, or outer and upper part of the crest where it curves round the top of the head, is black. Back, black ; wings, brown and white. Two crescent-shaped black lines (as in the smew) curve on the white ground of the breast from each shoulder, round under the neck, but do not meet. Bill and feet, dull red. Length, 17 to 18 inches. Female smaller ; head, reddish brown ; upper plumage dull brown.

This is by far the rarest merganser of the four. It has not been recorded quite a dozen times in England and Scotland, and less frequently in Ireland. The writer was fortunate enough to shoot three in the latter island during the hard winters of 1878 and 1881. It is a North American species, and this is the reason of its extreme rarity with us. The hooded merganser is very little larger than the smew.

SMEW.

Crest, neck, breast, and under parts, pure white ; back of the neck, black, shaded with green. Two crescent-shaped black lines curving from the shoulders on each side towards the breast, but not meeting. A greenish black patch round the eye and from the eye to the base of the bill ; feet and bill, bluish grey. Length, 17 inches. Female smaller ; head and cheeks,

reddish brown ; the under parts clouded with light grey. During severe winters this duck, like the goosander, is not uncommon on the coast and a short distance inland. But it is difficult to obtain an old male in his handsome white, black, and green dress, such being far less frequently seen than the females and immature birds. Like the goosander, the smew is never found in large numbers ; only a few are scattered here and there, and oftener than not single birds, or twos and threes, are seen, especially when met with inland on rivers and meres. The smew is the smallest of its species.

DIVERS.

Of the genus *Colymbus* or true divers (which are not related to the diving ducks), there are three species that visit our shores. These include 'the great northern diver,' 'the red-throated diver,' and 'the black-throated diver.' As to a wild-fowl shooter they are neither fish, flesh, nor fowl, and each is as worthless to him as a gannet or a gull, a cursory allusion to them will suffice. To a collector of natural history objects an adult of any one of these is a prize often sought for, and no collection of waterfowl is complete without them. In this genus the male and female are, like the geese, undistinguishable outwardly. The young birds are of a dull brown and ash-grey colour.

GREAT NORTHERN DIVER.

Bill, black, with the upper mandible straight and about four inches in length ; neck and head, black, tinged with violet and green. On each side of the neck, and one below the other, two patches of white streaked downwards with thin wavy black lines. At a short distance this marking gives the appearance of a double white collar. In a young bird the patches are either very indistinct or are absent. Upper parts and back strewn longitudinally with white lozenge-shaped spots ;

nearly a half-inch long over the wings; under parts, white. The mouth opens as far as the eye. Length, 32 to 34 inches; weight from 8 to 10 and even 12 pounds. This superb-looking bird, provincially known as the 'loon,' is to be seen on our coasts during winter. It is sparingly distributed here and there, and may usually be noticed diving and swimming alone, rarely in couples. Sometimes from six to ten of these birds may be seen dotted about the mouth of a Scotch or Irish estuary; on a few occasions we have noted as many as a dozen in sight at one time. The great northern is a prince among divers, riding easily in the stormiest sea. If a fowler wish to obtain a specimen, a heavy charge, a long-barrelled gun, and large shot are essential, and he must make the best of his first chance, when the bird is swimming high and buoyant, as when once fired at, or even suspicious of danger, this diver will career along as fast as a light sailing-boat, his body and vulnerable parts out of sight, the water rippling over his back. His head, it is true, is left as a mark to aim at, but it is a very small target at fifty or sixty yards, for he will rarely let you come to closer quarters, and, even at the distance named, will probably be under water the instant you fire, for the very motion of pointing a gun is enough to scare so shy a bird. These divers have long been supposed to nest in Scotland, but no such event has yet been recorded on authority. They are rarely seen on wing, and then only in the spring previously to their leaving us. Their cry is weird and plaintive—a long drawn note of distress. It sounds unearthly in the dark as we have now and then heard it when within a few yards of us while waiting for the moon to rise to get a shot at duck. The great northern diver, if alarmed or when fishing, disappears from the surface in an extraordinarily rapid yet quiet manner. No splash is to be seen, nor does the bird jump forward and take a header after the manner of the cormorant or diving ducks; there is merely a quick downward bend of the head, and the bird slips out of sight head first without a ripple and well-nigh before the fact can be realised by the spectator. This bird, as well as the two next mentioned,

is seldom seen with us in its pride of colour and plumage, as only in summer is it perfect in this respect. Their plumage begins to change in late autumn, and returns just as the birds migrate in the spring.

RED-THROATED DIVER.

This is much the most numerous species of the three on the English coast, and is also the smallest, being in length only 25 to 26 inches. It is a similar bird both in shape and habits to the one just discussed. In an adult bird the throat is rich chestnut red. The spots on the back are small in size, compared with those on the plumage of the great northern diver. These birds are also known as 'loons.' They are rarely seen in England with the beautiful red throat peculiar to them during the breeding season, having in the winter a white or grey one instead. For this reason they are not spoken of as 'red throats' here, as is the case in the localities where they nest. They breed freely in the north of Scotland and its islands. Unlike the northern diver, this bird is so numerous off our shores that numbers of them may be seen flying or swimming together. While flying, they frequently utter a hoarse wailing note. They are particularly restless and loud of voice before a term of wild weather or much wet. In some parts they are known as 'rain geese,' as it is supposed that they indicate wet weather by their uneasy movements.

BLACK-THROATED DIVER.

Length, 25 to 28 inches; a larger and heavier bird than the last, but very similar in shape. The adult when in full plumage has the neck velvety black, glistening with green and violet. The front and sides of the neck are streaked with white and black; head, ash-brown; upper plumage handsomely barred with black and white; under the throat a narrow band streaked with white and black in wavy lines. The immature and females

of this diver and of the great northern are scarcely distinguishable from each other. In fact, the whole three bear so strong a resemblance when young that this species is frequently overlooked by a casual observer. Though rather a rare bird in England and Ireland, it is numerous and breeds in the north of Scotland. It also nests on the Hebrides, and has lately been proved to breed in Ireland.

GREBES.

Very similar in habits and shape to the divers last described, though much inferior in size. All grebes excel in diving and

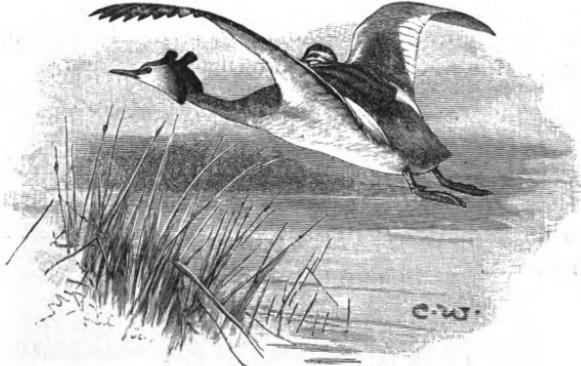

Grebe and young.

swimming. They are remarkably graceful in their motions, and just as wary and hard to obtain as are the large divers. On account of their beautiful satin coats, they are valuable. No bird is more perfectly formed for diving and swimming than a grebe. The wings present a knife-like edge to the water; the powerful webbed feet, placed far back, are wonderfully adapted to assist the bird's motion when he is diving or swimming, or when he uses them as rudders. The long tapering neck, with a head like a snake, and the pointed bill, offer the least

possible resistance when progressing under the surface. The smooth, shining, and rounded breast throws the water on either side like a ship cleaving the waves as the bird careers rapidly forward.

There are five species of grebe :—

THE GREAT CRESTED GREBE,

together with other divers, is indiscriminately called a 'loon.' Its length is 21 inches, and it is much the largest of its genus. It nests on most meres and lakes in the British Islands where it is protected, and where reeds and quiet corners abound. These birds, however, are never numerous, and a pair or two are as many as will frequent a fairly large mere. The species may be distinguished in the summer by a large and handsome crest, and a frill on the neck of brown and chestnut.

THE RED-NECKED GREBE

is a somewhat rare species with us, and does not exhibit the long crest of the variety just described ; it is also smaller, being only 16 inches long. It has never been proved to nest in the British Islands.

THE EARED GREBE.

Length, 12 to 13 inches. A very rare species, which formerly nested in our fens and Broads, but at the present day is a non-breeder in our islands.

THE SCLAVONIAN GREBE

is another rather uncommon species, but not nearly so rare as the last. An adult in summer has a curiously striking plumage, consisting of two curved crests or tufts of orange red, the breast and neck being bright chestnut. Bill, black, with a tail tip. Length, 13 inches. Young birds and females of this and the previous species closely resemble one another. Also a non-breeder with us.

THE LITTLE GREBE, OR DABCHICK,

frequents and nests regularly in our lakes, ponds, and streams. This bird is familiar to most people—a bright, merry little sprite, and as good at a dive as the best of his species. We have many times, when we have met with them on salt water, seen them fly, especially if collected together, but they rarely rise off the water when seen inland. This bird often baffles search by covering up her nest and eggs when leaving them. Length, 9 to 10 inches.

R. P. G.

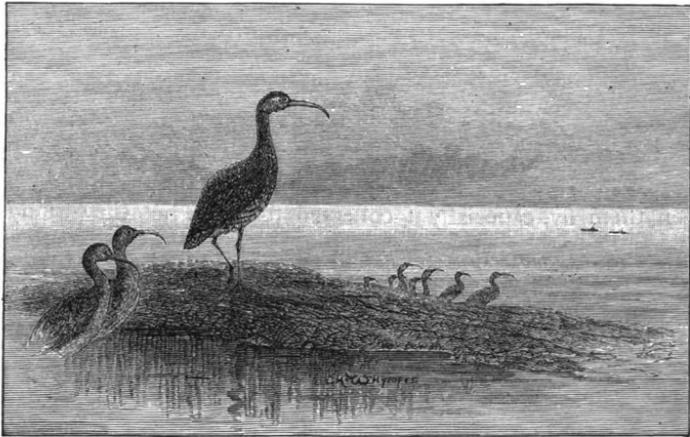

Curlew.

CHAPTER X.

WADERS.

HAVING now completed our observations on the swans, geese, ducks, and divers, we will deal with the waders, birds that are one and all dear to the unpretending shore shooter, who does not venture afloat, nor possess all the expensive necessaries indispensable to a punt gunner.

The various shore birds and waders that now follow comprise such a large class that it is quite impossible to do more than describe the best known species. Most shore gunners, however, take a delight in securing and examining the rarer specimens of these interesting birds, many going so far as to preserve and collect examples of all they can obtain. Hence a list, however brief, will we trust be of service to such collectors.

PLOVERS AND SANDPIPERS.

The GREEN PLOVER is commonly known as the 'peewit' or 'lapwing,' two well-chosen names, derived, the first from the

bird's well-known call, and the second from its flight. A minute description of this plover is unnecessary. It is well known as one of the commonest birds we see, and is yearly increasing in numbers in our islands. It is a bird that, from its peculiar rounded wings and unsteady flight, may be recognised at a great distance, when most other species would be doubtful. The wings of a peewit when the bird passes near cause a loud hum in the air. Hence the French name of 'vanneau,' a fan. It is resident with us, and generally distributed everywhere, though its numbers are largely increased by migratory birds in the autumn. It lays four eggs, placed crosswise in the nest, and begins to lay as early as the end of March. To test plovers' eggs when found place them in water; if fresh and fit for food, they sink on their sides, if not, they float large end upwards.

If during the breeding season you are searching for eggs and a plover gets up and flies straight away, it is the female, and there is a chance of finding the nest. But if, on the other hand, the bird that rises twists and wheels overhead, you may be sure that it is the male. If the female flies off very low her eggs are usually four in number and have been sat on; if she flies high she will have but two or three in the nest, and these but lately laid and therefore good for food. The peewit collects in early winter in vast numbers on low ground, especially on young wheat fields, not to destroy the crops, but because the newly turned earth affords it food in the shape of insects, and the surface is level to walk on. Should frost set in these birds are at once off to the coast, and should hard weather continue they voyage south, not to reappear even in case of a thaw, or to do so only in small numbers.

In the spring a great many nesting birds and males will reassemble, but never to anything like the extent they do in the autumn. In a wet winter they do not shift their quarters. They are netted in thousands in Ireland by a few men who make a living thereby, keeping secret the working details of their appliances. We have known them take in one fall of

the net over one hundred plover, both green and golden, and as many as a thousand during a week.

This netting of plover is a fascinating sport, as the birds are taken on the wing. The net, previously laid flat on the ground, springs up just as the wild birds swoop down over the stuffed decoys. The trigger line that frees the net from its catches is pulled by the fowler as he lies concealed a hundred or more yards off. The net and operator must be quick as thought in action, or not a bird will be taken. The mode of working the net is easily learnt, and can be applied by any sportsman whose lands are frequented by plover, to the benefit of both his pocket and his table. For a copious explanation, plans, and all instructions, the reader may be referred to 'The Fowler in Ireland,' already mentioned as published by Mr. Van Voorst.

GOLDEN PLOVER.

The golden plover is so called from its beautiful golden markings. It is a graceful, gentle-looking bird, with a peculiarly soft and liquid eye. During the nesting season its throat, neck, and lower parts turn to a rich velvety black. It breeds numerous in Scotland and Ireland, and to a less extent on the moors of England and Wales. As soon as frost sets in, it deserts its inland quarters for the seashore. It is a delicate species, and throughout the winter is constantly on the move southward to escape the rigours of climate. It is rarely seen in such large numbers as is the peewit, but as it flies with closed ranks it does not perhaps appear to be so numerous as it really is. Golden plover fly straight and quick, frequently in a V-shaped bunch, and never waste their time wheeling aimlessly in the sky as peewits do. In late autumn the expert fowler may often obtain upwards of fifty at a shot from a swivel gun, indeed we have many times bagged from eighty to a hundred by such means at a single discharge.

Like the peewit, the golden plover is numerous in many parts of England during wet winters, both inland and on the green

meadows near the coast. In severe seasons it is everywhere scarce. This plover and the peewit are peculiarly restless before wind and rain, flying hither and thither, and uttering their weird—and, in the case of the latter, mournful—notes. No bird, to our mind, utters a cry more in harmony with the wild and sombre scenery of the marsh or seashore than does the peewit or the golden plover. The last named is in parts provincially known as the 'whistling plover' from its note. It is a daintier bird to eat than the peewit, but the latter is excellent too, and many people would scarcely tell the difference.

Golden plover are usually offered for sale at a much higher price than peewits. When seen before being cooked the distinction is obvious, but when cooked it is not so easy to tell them apart as the two species are so similar in size. The absence of the hind toe in the golden plover is a safe mark whereby it may be distinguished. If a plover is put on the bill of fare, and charged as a golden, the diner will do well to examine its feet. The length of the bird is between 11 and 12 inches.

GREY PLOVER.

This species appears on our shores in spring and autumn in fair numbers, but is not nearly so numerous as the two last-named. It usually occurs singly or in small trips of six to ten. It is essentially a seashore bird, and is very seldom seen inland. The grey plover also possesses a hind toe like the peewit, but it is so rarely offered for sale that it would not be likely to interfere with the caution given concerning peewits and golden plover as food.

In the breeding season the grey plover exhibits a lovely breast and neck of velvety black, like the golden. When immature, it closely resembles the young golden plover, as it then has yellow spots on the back and breast, but its fourth or hind toe is here again a useful mark of distinction. Like the golden, the grey plover may often be seen, either alone or in

small numbers, sociably feeding with all kinds of shore birds from curlews to dunlins.

It is about the same shape as but somewhat larger than the golden plover, the upper parts of the plumage being speckled with black, white, and grey, instead of with brown and yellow. The long, black feathers under the wing (known as the axillaries) of a grey plover are also a distinctive mark, as they can be plainly seen should the bird fly near. In the 'golden' these plumes are pure white. This bird never breeds with us. Length, 12 inches.

NORFOLK PLOVER.

Also known as the 'thick knee' and 'stone curlew.' Length, 17 to 18 inches. A summer visitor, arriving in April and leaving in September. It breeds sparingly on open heaths and warrens, and is rather a local bird. It is never seen in numbers, but now and then, previously to its migration in September, Norfolk plovers collect together for some days before leaving. They are much more numerous on the heaths of Norfolk and Suffolk than elsewhere, and are almost unknown in Scotland and Ireland.

DOTTEREL.

Length, $9\frac{1}{2}$ inches. A summer visitor rarely met with on the coast, since on its arrival from the south in spring it makes its way directly for the higher moorlands, where it breeds sparingly. It is a larger bird than the ringed dotterel, from which it may be distinguished by the chestnut and black plumage of the under parts.

RINGED PLOVER.

Sea-lark, stone-trotter, or ringed dotterel. Length, $7\frac{1}{2}$ to 8 inches. A well-known and beautiful little plover that frequents our shores all the year round. It also visits in small numbers inland waters during the spring and autumn migration, when

there is a considerable accession to the numbers of the resident birds. It nests freely in hollows in the sand or shingle just above high-water mark.

This bird may be at once detected by its handsome plumage; a patch of black across the forehead and eye towards the back of the head; a white ring round the neck; beneath that a broad band of black, over the white breast. Though scarcely worth a charge of shot, these are very interesting birds to watch, their movements on the sand or ooze are so nimble and pretty. We know of no bird that can trot along so fast; its legs seem to 'twinkle' as they cross one another, and all the time the little fellow is scurrying along he is engaged in snatching up dainty bits from the mud or sand. The ringed dotterel may be seen here and there on the coast in varying numbers, either in pairs, or in groups of twenty or thirty. They are seldom, however, to be observed in 'congregations' like the green or golden plovers.

LITTLE RINGED PLOVER.

A very rare species, which has been recorded only about a dozen times in our islands. In size, shape, and plumage this bird is a miniature ringed plover. Both show a black patch near the eye, as well as a broad black band on the breast. The rest of the neck and all the under parts are pure white.

KENTISH PLOVER.

Length, 6 to 7 inches. A rare species in our islands except on the shores of the county from which it derives its name, as well as on the adjacent coast of Sussex. In these counties it is by no means numerous, but breeds regularly in small numbers. It may always be distinguished by its sandy coloured head and by its slaty black legs and feet, these parts being yellow in the ringed plover and little ringed plover.

OYSTER-CATCHER.

The oyster-catcher, or sea-pie, a handsome black and white magpie-looking bird, with a bright orange bill, is of no use for food or sport. It is abundant on some parts of the coast, and breeds freely. It bears a strong resemblance to a widgeon at a distance. In Scotland a thousand or more may sometimes be seen collected together, but it visits England and Ireland in more moderate numbers; perhaps a score or two may be noticed flying together, oftener but two or three.

TURNSTONE.

To be seen chiefly in the spring and autumn, and though always in limited numbers, still a very regular visitor. The turnstone is a handsome bird, about as large as a thrush, and having a black, chestnut, and white appearance. It derives its name from its habit of running about on the beach, and turning over stones with its bill in order to obtain the small crustacea that lie underneath. We have often seen one turnstone run up and assist another in doing this, and have even noticed three of them at work raising one stone like quarrymen with their crowbars. They do not merely lift a stone and reach under it, but gradually hoist it up till it balances upright, then with a great effort the stone is pushed over, and all is exposed underneath. If a strange turnstone appears on the scene, who did not assist in the work, there is a great scrimmage, and the interloper is sent about his business. We once watched two turnstones for a full hour trying to turn over a dead fish nearly a foot long, without success. We longed to help them in their struggles, but dared not come forward for fear of frightening them away. Finally, with a strong heave and a heave together, over went the fish, to our very great gratification. It was a pleasure to see through a glass how the birds revelled in all manner of creeping things which their hard-won success had exposed to view. Length, 9 inches.

AVOCET.

An occasional summer visitor, although at one time it used to breed in the marshes on the east coast of England. A handsome black and white bird, in plumage something like an oyster-catcher, in shape like a curlew, but with the bill turned upwards as much as a curlew's is turned down—an unmistakable characteristic. Length, 18 inches.

BLACK-WINGED STILT.

A rare visitor, that has been recorded about five-and-thirty times in our islands. Length, 12 to 13 inches. May be known at once by its black and white plumage and long stilt-like and slender legs of a bright pink colour.

GREENSHANK.

Not nearly so numerous a bird as the common redshank, but is, nevertheless, not unfrequently to be met with in our estuaries and tidal harbours. It may be known by the extreme length and green colour of its legs. Length, 14 to 14½ inches. It nests sparingly in the north of Scotland.

SPOTTED, OR DUSKY REDSHANK.

A rather rare species, occasionally obtained during its migration along our shores in spring and autumn. It is somewhat longer in the leg than the common redshank, and has a longer and more slender bill. In its summer or breeding plumage, the under parts are nearly jet black. Length, 1 foot.

COMMON REDSHANK.

Resident, but migrates in spring and autumn. Fairly numerous, but usually seen singly or in small trips of from six to a dozen birds. A restless, fidgety bird, always on the move.

It has a peculiar habit of nodding and jerking the head when walking or standing on the ooze. It is a watchful sentinel, and does much harm to the expectant gunner by alarming with its shrill whistle more valuable fowl. Length, 1 foot.

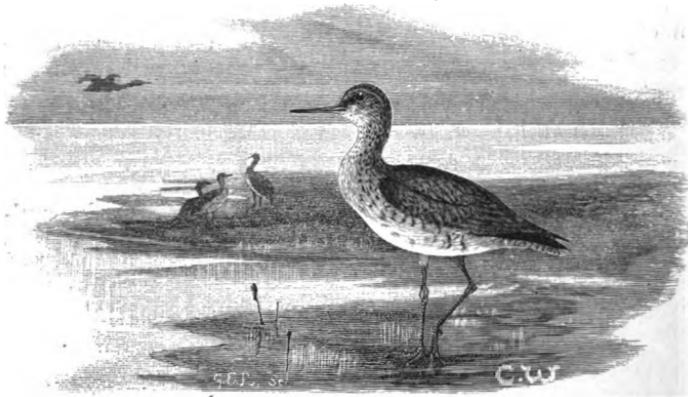

Redshank.

YELLOWSHANK.

Has not occurred in England above half-a-dozen times. Its legs, being long and yellow, have suggested this name for the bird. Length, 10 inches.

SOLITARY SANDPIPER.

Has occurred on two occasions in England, and in appearance closely resembles the wood sandpiper. It may be distinguished, however, by having the upper tail-feathers greenish brown instead of white.

GREEN SANDPIPER.

A spring and autumn visitor, occasionally seen in winter. It is of solitary habits, and never numerous; usually to be seen

inland about drains and small streams, and is a very shy bird, with a peculiarly shrill call note. Length, $9\frac{1}{2}$ inches.

WOOD SANDPIPER.

A spring and autumn visitor, rarely observed in winter. It is somewhat uncommon, but is now and then to be seen in small parties about marshy land near the coast. It strongly resembles the green sandpiper in habits and appearance, but is a smaller bird, being only $7\frac{1}{2}$ inches long. It nests freely in Holland, as well as in Norway and Lapland.

RUFF.

A spring and autumn migrant in small numbers, breeding occasionally in Norfolk. It is not often seen in the plumage from which it derives its name, that being peculiar to the breeding season, and may therefore at other times easily be mistaken for a redshank or some other wader. Length, 10 to 11 inches.

BARTRAM'S SANDPIPER.

An American species of equally rare occurrence. Length, 12 inches.

BUFF-BREASTED SANDPIPER.

Another American species, and as rare a one as the last-named. Length, 8 inches.

THE COMMON SANDPIPER, OR SUMMER SNIPE,

visits us in April or the beginning of May, and remains till August or September. It is never seen in numbers, but singly or in pairs. It breeds freely, but less numerously in the south of England than in Ireland and Scotland. It is a bird well known to most anglers, and may be seen darting about among

the stones and shingle of the rivers, every few moments flying a yard or two in search of food. It is a very active little wader, and can both swim and dive well if wounded. It keeps its body in constant motion, specially the tail, which it never ceases jerking. Hence in some parts it is locally known as 'Wagtail.' Length, 7 to 8 inches.

SPOTTED SANDPIPER.

An exceedingly rare American species, which has occurred a few times in England. Length, 8 inches.

KNOT.

A spring and autumn visitor, seen less frequently during winter. In some winters we have, however, observed large numbers, and we once killed 160 on a sandbank in January with a swivel gun at a shot, having mistaken them in the dusk for golden plovers. Length, 10 inches.

PECTORAL SANDPIPER.

A North American species, which has been recorded about a score times. Length, 9 inches.

CURLEW SANDPIPER, OR PIGMY CURLEW.

A spring and autumn visitor, though now and then to be seen in winter. In the autumn these birds are not uncommon, and may be found in small parties of from two or three to six or seven. We have frequently noticed them associating with knots, dunlin, and purple sandpipers. They are probably much more numerous than is supposed by reason of their strong resemblance to the dunlin at a short distance. The length of the beak in comparison to the size, and the resemblance it bears in its curve downwards to the bill of a curlew, are very characteristic marks of the curlew sandpiper. Length, $7\frac{1}{2}$ inches.

PURPLE SANDPIPER.

A regular visitor, that remains throughout the winter on our shores; never numerous, but not uncommon. This bird is usually observed in small parties of five or six. It may be occasionally seen in summer, and this fact has led to a supposition that it breeds with us, but neither its eggs nor nest have yet been discovered in our islands. Length, 8 to $8\frac{1}{2}$ inches.

DUNLIN.

A migratory bird in spring and autumn, but abundant throughout the winter on all the shores of our islands. It breeds in fair numbers on the moors in the north of England, and more numerous in Scotland. The dunlin chooses the same sort of ground for nesting as does the golden plover, and as they are consequently often seen in company, the smaller bird is locally known as 'the plover's page.'

Dunlins are by far the commonest shore birds we have, and may be seen wheeling about the ooze in thousands. Their evolutions on the wing are extremely beautiful, for they change their flight as one bird; at one moment, showing their white undersides, they look like silver spray, the next their dark upper plumage causes them to appear like a dusky cloud sweeping past. Length, 8 inches.

BROAD-BILLED SANDPIPER.

Another rarity that has occurred very seldom with us, though it is common in some parts of the north of Europe. It is fairly plentiful in Norway. Length, $6\frac{1}{2}$ inches.

BONAPARTE'S SANDPIPER.

Also an American species, even rarer in this country than the last two, as it has not been recorded in England more than half-a-dozen times. It bears a close resemblance to the dunlin, but is slightly smaller, and has white upper tail coverts.

LITTLE STINT.

A spring and autumn visitor, most numerous in the months of August, September, and October. Though scarcely what may be called a rare bird, it is somewhat uncommon, and small parties of a score may be occasionally seen, oftener sixes and sevens. This is a dainty-looking little fellow, much smaller than even the dunlin, being only from five to six inches in length.

TEMMINCK'S STINT.

A rarer species than the last, though a regular visitor in limited numbers to our eastern coasts. It may be distinguished from the little stint by its white outer tail feathers and pale coloured legs, those of the little stint being black. Length, $5\frac{1}{2}$ inches. It is almost unheard of in Scotland and Ireland.

AMERICAN STINT.

A rare straggler from America, that has occurred but two or three times in the south of England.

SANDERLING.

This bird frequents our shores in considerable numbers during spring and autumn, and in smaller numbers throughout the winter. It is very similar to the dunlin in appearance when on the wing, and about the same size, but may be at once distinguished from this bird by the absence of a hind toe. Length, 8 inches.

PHALAROPES.

The phalaropes are very interesting little birds of sober habits and plumage, and have a peculiarity that none of the waders we have been speaking of possess. They can fly and run like a sandpiper, and yet float and swim on the surface of the water with the ease of a duck or seagull. The broad lobes

on the toes which enable these birds to progress in the water are the chief and unmistakable characteristics of the species. They will alight and paddle about in a rough sea with great buoyancy, and rise with ease. They then look like sandpipers drifting about.

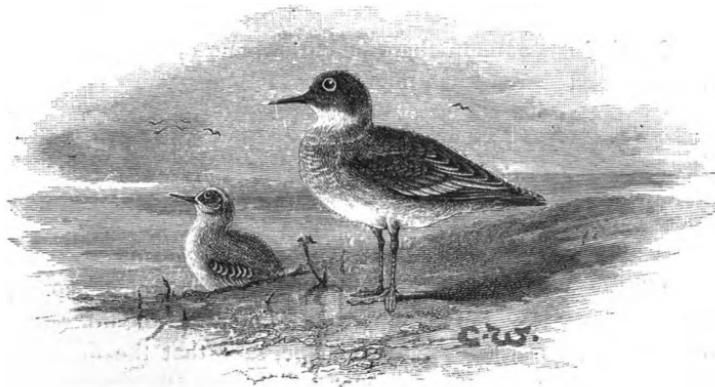

Phalaropes.

RED-NECKED PHALAROPE.

An infrequent visitor to England during winter, though not a rare one. It is almost unknown in Ireland. This bird breeds in the northern parts of Scotland and the Hebrides. Length, 7 inches.

THE GREY PHALAROPE.

Occurs regularly in small numbers in the autumn, but after severe gales at that period these birds occasionally appear in considerable numbers in an exhausted condition. Unlike the last-named, they do not remain to breed with us. Length, 8 to 9 inches.

CURLEW.

Generally distributed and well known; breeds numerously on the moors of Scotland, Wales, and the north of England,

and more sparingly in a few of the midland and southern counties. Its cry, which so closely resembles its name, is unmistakable. It frequents all parts of our coasts during winter. Length, 22 to 27 inches.

WHIMBREL.

Much less common than the curlew, and only seen during spring and autumn when migrating. It bears an almost exact resemblance to a curlew of small size. It is known in some parts as 'the Maybird,' from being more numerous during May than in other months. Length, 17 inches.

BAR-TAILED GODWIT.

'Sea-woodcock'; 'half curlew'; fairly numerous in spring and autumn, a few remaining the winter. Resembles the curlew in its habits, as also in shape, save that the bill of a godwit may be described as straight, though slightly inclined upwards at the end. Length, 16 inches.

BLACK-TAILED GODWIT.

A much rarer species; also a spring and autumn migrant. May be known from the last described bird by having nearly all the tail black, while the tail of the previous species is barred with black and white. Length, 17 to 18 inches.

GLOSSY IBIS.

This beautiful bronze-tinted bird, in size and shape like a small curlew, was at one time not uncommon on our eastern shores, where it was known to gunners as the 'black curlew.' It is now of rare occurrence. Length, 22 inches.

SPOONBILL.

Unmistakable from its spoon-shaped bill and snow-white plumage. It used formerly to breed in heronries in England,

but is now only met with as an occasional visitor, generally in autumn. Length, 30 to 32 inches.

COMMON HERON.

Length, 3 feet 2 inches. A well-known bird ; nests in many suitable localities, such as trees near rivers and lakes, in pairs as well as in colonies, their presence depending upon the protection and natural shelter afforded them.

PURPLE HERON.

A rarer bird than the last ; occurs now and then in England. Very uncommon in Scotland and Ireland. Length, 3 feet. This bird has a rich plumage of red and purple, the common heron being grey, black, and white.

NIGHT HERON.

An occasional visitor of very retired habits. One or two are recorded every few years in some part of our islands, where, however, it does not breed. Length, 20 to 22 inches.

SQUACCO HERON.

A rare species which has only occurred twenty to thirty times in Great Britain. Length, 19 inches.

COMMON BITTERN.

A not uncommon bird in marshy lands during winter. It used formerly to breed in the fens. Length, 2 feet 4 inches.

AMERICAN BITTERN.

A much rarer species, that has occurred about a score of times. Length, 23 inches.

LITTLE BITTERN.

A summer visitor that is usually recorded a few times every year. A quaint imitation of a bittern, but about the size of a fieldfare. Its legs are very short in proportion to its body. Length, 13 to 14 inches.

R. P. G.

CHAPTER XI.

RAILS AND CRAKES.

WE will next notice a class of birds, some of which offer attractions to a fowler, namely the rails and crakes, which, though they make long migratory journeys, are remarkable for the shortness of their wings and their apparently feeble flight. They are all of skulking and retired habits, and but seldom seen.

LANDRAIL, OR CORN CRAKE.

A summer visitor to this country. A few occasionally remain the winter, but these are generally regarded as wounded birds, or individuals of late broods. It is chiefly found in corn, clover, and mustard, which afford it cover, and usually takes its departure in the autumn as soon as it is deprived by farming operations of its natural shelter. Such a shy bird would seldom be discovered but for its loud voice, and it is curious how few people have seen it in the flesh. It flies heavily with the legs hanging down, and truly it does not look capable of a voyage across the ocean without a rest. Its long legs, and slender, compressed body are of great use to it in running amongst tall herbage. Length, 10 inches.

Next to the woodcock and snipe, the landrail holds an equal position with the teal and golden plover as a table delicacy.

WATER-RAIL.

Not nearly so common a species as the last-named, but yet more numerous than is generally supposed on account of its

equally shy habits and more or less inaccessible haunts. It is met with in marshy land amid long grass and rushes, by the sides of ditches, or of sluggish reed-grown streams and muddy pools. Its note is totally different from that of the landrail, being something akin to a short cough, and now and then to a low, harsh whistle. It is about the same size as the landrail, being $11\frac{1}{2}$ inches long, but has a much longer bill.

The water-rail can swim and dive when followed by a dog, and when closely pursued will fly. This it does after the fashion of a corn crake, with the legs hanging down, and it is if possible even more sluggish and heavy on the wing. As soon as the bird is much pressed on land, and obliged to leave its hiding place, it rises, flying low over the herbage, and gives the idea that it is on the point of alighting; yet notwithstanding its awkward flight this bird passes in its migration over wide expanses of sea.

Water-rails, in small numbers, are resident with us all through the year, but are less frequently observed than land-rails, having the advantage over their cousins of the farm in being seldom deprived of their natural shelter by the operation of mowing. It is worth notice how beautifully the feet of the rails and crakes (excepting the landrail, which haunts dry soil) are adapted for running over water-plants and weeds, the great length and spread of the toes being sufficient to support them where a mouse could not walk safely.

SPOTTED CRAKE.

Length, 8 to 9 inches. Not so numerous as the water-rail, but by no means an uncommon bird—sometimes even numerous—and very similar to the water-rail in its habits. It breeds in small numbers in the marshes along the north-east coast of England, and is at all times more abundant on that portion of our islands than elsewhere. The Carolina crake has occurred only once with us.

BAILLON'S CRAKE.

Length, only $6\frac{1}{2}$ inches. A great rarity, but its nest has on a few occasions been found in England, chiefly in Norfolk. It has been seen at all times of the year, and is therefore considered a resident. It is almost unknown in Ireland and Scotland; in the former country it has occurred but three times—in the latter but once.

LITTLE CRAKE.

Length, $7\frac{1}{2}$ to 8 inches. Like the last bird, this species has also been seen throughout the year, and is therefore considered a resident in small numbers; it is not, however, such a rare species in England as the last noticed, but has only been recorded twice in Ireland and once in Scotland. Both these small and rare crakes frequent reedy swamps and marshes—places in which, even if they were numerous, they would, from their shy habits, small size, and disinclination to fly, be completely hidden from observation.

We have on many occasions gone purposely on a moonlight night to a swamp which we knew all manner of water-birds frequented, to listen for unusual call notes, and we have often heard calls that we could not identify as proceeding from the throat of any bird but one of these small crakes. Yet, on the following day, when carefully beating the place, we never succeeded in seeing one, though the dogs seemed constantly footing some bird or other, after they had driven out the ordinary water-rail amongst various other species. This family of birds, including the corn crake, are always most distinctly heard on a fine calm night with an early moon.

THE WATER-HEN, OR MOORHEN.

A very well-known species on our ponds and streams, resident throughout the year. It is a solitary bird, and is usually

seen in pairs. It is generally distributed and breeds freely. It is, however, a very tame bird, and may be called, in some places, semi-domesticated. It is rarely seen on open waters, and then never far from the bank. It loves small pools overgrown with high reeds and rushes, and stagnant water, such as is to be found in ditches and drains. The water-hen will wander a long distance in search of food, and is certain to be the first water-fowl to appear on a new-made pond. We have found water-hens in all sorts of strange places, under hayricks, in rabbit holes, and frequently in low trees and bushes by day. We once caught one by night in the ivy of an old tower, when netting small birds to feed a 'tiercel.' In frost, water-hens are often seen in hedgerows and turnip-fields, whither they have wandered in search of food.

The young of the water-hen has so many enemies, such as herons, crows, and even pike, that comparatively few come to maturity. This fact is very noticeable on any piece of water frequented by these birds.

THE COOT.

Another common and well-known species. Generally distributed, resident all the year round, and nests freely. During winter, coots assemble on open waters, and keep together like other wildfowl, such as duck and teal. In summer they are, of course, nesting and dispersed. When forced to seek the coast owing to frost covering their fresh-water haunts with ice, they fall victims to punt gunners and shore shooters. On their first appearance they are excellent eating, but to pluck them is well-nigh an impossibility. It is best to pluck the long feathers, then rub well with resin, and so peel off the down next the skin, which by this method can easily be done; and it is worth knowing that a coot is always best for the table if shot early in the day. There are, however, at all times of the year small parties of coots, paddling about the estuaries, that do not go inland with the others when the frost breaks

up, or when spring sets in. These are, in our experience, old males.

Like the water-hen, a coot can run on mud or land, and is not in the least awkward ashore. It is also a far better performer in the water than is the former bird, as its toes are lobed, which enables it to swim like a duck. A coot acts much in the same way as a water-hen when on land or water, moving its head in a similar eccentric fashion. Coots can fly admirably; when once on wing they go at a great pace, and get wilder and fly higher every time they are put up. We have seen several thousand coots together, but they are unsatisfactory birds to follow or shoot at; for, though their numbers look very dense at a short distance, a nearer approach will discover that, unlike a pack of widgeon, they are in reality much less numerous than at first appeared, each bird being a little apart from his neighbour. We once followed without success for several days a pure white coot. We had already shot a very fine black one, and hoped to get the other to place beside him as a contrast in a case; but our pursuit was not successful, a hard frost set in, and off went all the coots, the wished-for prize included, to some distant quarters.

The best shot we ever obtained at coots with a swivel-gun was by flying an imitation falcon over them. Their movements were very curious and satisfactory the first time, for they 'wedged' together and crowded from all parts of the lake to its centre as if for mutual protection. But, hoping to be equally successful on another occasion, we were disappointed, for every bird flew away to a distant and much larger lake, and they only came straggling back again after nearly ten days had elapsed.

We have now got through the long list of water-fowl and waders, all of which a fowler may at various times and places fall in with, except those few which we have been careful to point out as 'rarities.' These latter are, of course, most interesting to the many fowlers who nowadays collect specimens, and we hope, therefore, the few notes we have given of them will

be found useful and convenient for reference by shooters who are on the look-out for scarce birds. As we have previously remarked, no man can be called, or hope to be, a successful wildfowl shooter unless he knows something of the distinctive characters, haunts and habits of the many species he is in search of.

R. P. G.



A Tramp in the Marshes.

CHAPTER XII.

WILDFOWL SHOOTING ON SHORE.

THOUGH we have described the birds, rare and common, which a fowler may meet with, we still have a good deal to say concerning guns and various methods of shooting as yet only briefly referred to. But before describing the various *impedimenta* that a fowler requires when shooting afloat—the perfection of wildfowling—something must be said about ‘shore-shooting.’

A shore-shooter—or ‘shore-popper,’ as he is rather contemptuously called by the punter, who, with his scientific and costly rig-out of punt and big gun, is apt sometimes to speak slightly of those less fortunate than himself—may be as good a sportsman as any that shoulders a gun ; for, in our opinion, it is a sure mark of a true sportsman to be contented with a small and hardly-earned bag of wild birds. Puntsmen, as a rule, are very strong in their remarks about shore-shooters, because

the latter when pursuing their sport now and then prevent the former from obtaining a shot, by firing on shore and so frightening the birds up when a shot on the water was expected. The puntsman is apt to exclaim, 'I lost a dozen fowl through that — fellow on shore firing just as I was getting within shot !'

This is all very well, but the shore-shooter might not have seen the gunner's fowling punt, and in any case it would be hard for him to refrain from shooting at a bird he prizes in order that somebody else, about whom he knows nothing and cares less, may or may not get a dozen. Though the shore shooter may have slain but a curlew, a curlew often requires as much stalking on shore as a company of widgeon does on the water, and probably when a shot at widgeon is never obtained, a shot at curlew is considered something worth seeking. Few allowances are made by a punter for the man who has to tramp miles of shore for a bird or two. Of course, as we know from experience, birds are sometimes purposely driven away from the gunner afloat by jealous shore-shooters ; but this is the exception.

In wild countries we have even had bullets fired out of shore-shooters' smooth-bores both at our punt and at the fowl we were approaching for a shot, but this practice soon ceased when we took to carrying a Winchester repeater on board, and so were able to return the salute rather too near to be pleasant to the aggressor, especially when he would unwisely take a shot at us from under a bank with no shelter for half a mile or so.

The charm of shore-shooting is its variety—at least, it is so to the man who knows one bird from another. It has another strong recommendation, and that is it requires a perfectly broken retriever, one that will face the breaking surf, and fight his way out to bring you the plover or knot you have dropped in the sea, which the chances are the gulls would otherwise rend and spoil ere it drifted ashore. What companionship there is in the presence of a retriever when flight-shooting ! How quick he is to hear the whistle of pinions overhead ! how earnest to retrieve the birds as they drop to the shot far away in the dark-

ness of marsh and reed, or maybe among the rocks and weed of the seashore!

Alas! that flight-shooting is of such short duration—twenty minutes at most, often less. It is superb sport for a shoulder gun. At what a pace the birds come, and how heavily they fall when killed!—seen for an instant as if from the clouds, and the next moment lost in the shade of night.

The wilder the night the better for fighting; the birds then fly low, and if against the breeze their pace is comparatively slow. Though of course they never pass by in broad daylight, they leave earlier than usual for their nightly haunts on a stormy evening, and are then far more easily seen than when they come in the dusk.

We once had the good fortune to get excellent fighting by day, but the chance was altogether exceptional. We were shooting snipe on a long spit of marshy land that reached far into a large lake. It had been blowing a gale from the south-west for some days, and every duck, widgeon, and teal for many square miles of water had collected for shelter on the calm side of the point. They were there in hundreds, but there was nothing to be done except to look at them with longing eyes. We continued shooting snipe with poor success till about four o'clock, and then took another look at the duck before turning homewards, in the hope of getting a shot at one or two which had been swimming near the shore in the morning. On reaching the shore it became apparent that the wind, which was still blowing a full gale, had veered to the north-east. We knew that this change would unsettle the fowl, as they were now on a rough shore and not, as before, in snug shelter, and the calculation soon proved correct. That evening every bird passed within fair shot overhead, though at a great speed, making for the other side of the point—now the smooth one. They came at first singly, then in couples, then in threes and fours, often in dozens. Pintail, teal, widgeon, and duck were hurrying overhead for quite half-an-hour.

Being fortunately well supplied with cartridges, as our snipe

shooting had not been nearly so good as we expected, we fired between seventy and eighty shots almost as fast as it was possible to load and fire, and until the ammunition was exhausted. Even then the birds were passing over, though the great bulk of them had gone. That day and the next we picked up, with the aid of a good dog, nearly fifty dead birds ; no doubt several escaped wounded and others fell at a distance. This, with No. 8 shot, may be regarded as good enough. It was the best half-hour's sport we ever experienced, or shall ever be likely to enjoy again. It was brought about by a sudden and unusual change of weather, and this long story has been told only to show what chances a shift of wind may bring to a shore-shooter.

The shore-shooter who wishes to be successful must be very patient and enduring, as well as wary and expert at finding wildfowl, and above all at stealing on them when found. The shooter afloat does not hope to do much good, as a rule, in a hard gale, but to the fowler on shore a gale from any point is an assistance—even from the south, if birds are about—for shore birds can be approached in wild stormy weather far more easily than in calms or in frost. Duck and teal haunt the drains and rivulets of the marshes near the sea on a rough day, and in such weather take less notice than usual of footsteps or firing.

When the country is covered with snow it is always well to carry in the pocket, when prowling along shore, a white overall, reaching below the knees, as well as a clean white cover to button over the shooting cap. It is wonderful what an addition these will cause to the day's bag if donned when fowl are about. If birds fly straight towards a shooter so dressed, and he is careful not to move either body, legs, arms, or gun till they are in shot, five times out of six they will not swerve till shot at, or at all events not till too late to save themselves from a well-directed gun.

Though birds of all kinds be wild as hawks during a frost, they become quite tame during the first six hours of a thaw, for they can then obtain their usual food again, which has been for

days, and perhaps weeks, denied them. When once they have made up for lost time, and enjoyed an abundant feed, they are as wild as ever.

It cannot be too strongly impressed upon a wildfowl shooter that he should make the best use of the first of a thaw, for the afternoon may prove too late, though the same morning might have filled his bag had he gone out.

If you wish to discover whether fowl frequent a certain creek or bay during night-time, or even a pool in the marshes



Waiting for ducks to drift in with the tide.

or fens, you cannot expect to do so from seeing feathers about, as these may have been drifting to and fro for weeks. Strike a match ; the sudden appearance of the spark (which at once blow out) will instantly set all the fowl within a long distance fluttering up, and you cannot fail to hear them. They will, however, peaceably re-settle in a few minutes, as the alarm was too quick and vanishing to have a lasting effect, as would have been the case had you shouted or fired a gun. Knowing that fowl are present, you can then lie in wait for them, either as they arrive

late in the evening or as they leave at daybreak. Be sure to take up a position with the wind behind you, as the birds are certain to rise against the breeze ; but avoid standing with the wind directly from you to them.

First-rate early flighting may be enjoyed on small meres and pools in preserved districts. We have often shot at daybreak from fifteen to twenty-five duck on a secluded piece of water in a short half-hour. The fowl, after feeding all night in marshes, fens, creeks, and on the banks of ooze at sea, fly to retired fresh-water pools to sleep and plume themselves after their night's exertions. They begin to arrive at such places a few minutes before there is light enough to shoot, and continue dropping in for the first quarter-hour of dawn, after which no more will appear. The gunner should take a stand on the sheltered side of the water, as on a windy morning the birds will pitch within range of the windward shore. On a fine calm morning success is uncertain in this kind of shooting, as the birds will alight all over the water and away from the shore ; besides which the smoke and smell of powder is liable to betray the shooter after he has fired a shot, and the next visitors, after a flight of inspection, see and scent danger, and sweep away to other waters.

It has been pointed out that a good dog is an indispensable companion to the shore-shooter or to one who tramps the fens and bogs. We have found no dog to equal the brown Irish spaniel, improperly known as a retriever. He is happier in the water than out of it, and from his small size can follow a teal or duck almost up a drainpipe. He is also a very keen sporter, an affectionate companion, and surely no animal in the world is more intelligent.

A word about firing at duck when flighting. They are most difficult to kill coming straight and fast at a shooter, unless within very easy shot, for a duck's breast is a mass of down and feathers.

In firing at birds which come fast and straight at you, if you miss it is nine times out of ten caused by shooting behind

them. Many writers on shooting say, 'Aim a foot in front of a bird,' or 'two feet,' or 'two feet and a half,' according to the pace at which it is travelling. What rare nonsense such direc-



Flight Shooting.

tions are! Who knows what aiming a foot in front of a bird means? Does it imply the space the shooter *thinks* is a foot at some thirty yards' distance, or does it mean a correct twelve inches before the mark?

To kill any fast flying bird coming straight at and above you, whether duck or not, the following is the most certain plan. Sight the mark just as it is in shot with your gun up ready to swing to the shoulder, follow the bird with your eyes, and just before pulling trigger throw the gun *well in front* of the object, and, tightening it to the shoulder by the same movement,—fire. We say nothing about feet and inches, for a little practice will supply the requisite experience for such shots; also remember that if you get the bird straight overhead it is easier to kill, on account of the shot pellets then getting under the feathers, as well as because all the vulnerable parts of the bird's body are exposed.

Now as to guns. We hear a great deal about the performances of large-bore shoulder guns, especially of the doings of 4-bores. Some makers advertise that these weapons kill well—mark the word *well*—up to 100 yards, and even do damage at 150 yards in what gunmakers call 'a flock.' Perhaps a flock of sheep may receive a few pellets at the latter distance, but a company of widgeon would not be in the least danger. Few know what a distance 150, or even 100, yards is, unless they measure it, though they may talk loudly of their extraordinarily long shots. A shore gunner will do far better with a powerful 12-bore, bored for Kynoch's brass cases, than with any other kind of weapon. These brass cases are of the greatest value to the fowler on land or water, and especially adapted to his requirements. They never stick, though—as has often occurred to us—they may have been dropped on soft mud and ooze. They can be loaded an indefinite number of times—a great advantage to a shore fowler who carries, as he must, various kinds of loads, suitable either for duck or tiny waders, and so usually fills his own cases from day to day to suit his sport. For ordinary game shooting they are not so suitable, but we should not like to give them up, when wildfowl shooting, for any other description of case.

In these days of breechloaders a gun can be charged so easily and rapidly that a single-barrelled gun is a very serviceable

weapon for a shore-shooter to use, as it is so light and handy. A fowler's shoulder-gun should be fitted with a permanent sling—an excellent addition the value of which very few Englishmen appreciate, though our continental neighbours would scarcely use a gun without it. For shore-shooting a sling is indispensable to a gun, for you can then throw your gun over the shoulder and have both hands free, whether to pick up birds, to warm your fingers in your pockets, to light your pipe, or for any other purpose. Laying a gun down in snow or wet is a bad plan. We shall never forget a lesson that we once learned when snipe shooting in Ireland, in a part of the country where the people were half savages and guns were scarce. We laid our gun against a bank, and went a score yards to encourage our dog to seek for a wounded bird in a rather treacherous bit of marsh. A pleasant-mannered native had assisted all day in carrying a heavy load of cartridges and game. He was a man whom we had never seen before, who casually accosted us and offered his services to point out the best snipe haunts. We found the bird, caressed the dog, and looked up to see our late assistant careering, barefooted, some quarter of a mile away, over the most shaky part of the swamp, as easily as if it had been high road. Our gun was in his hand, the bag of cartridges and game jolting about his shoulders—we need scarcely say never to be seen again.

Though large shoulder guns are sometimes of service in a boat, they are useless and cumbersome on shore. It is almost impossible to use them with sufficient rapidity for flying shots, and they are painfully heavy to carry. Their advantages by no means balance their many disadvantages.

A good 12-bore is more deadly in the hands of a shore shooter who knows what he is about than a much larger gun would be. People who possess these large shore guns think that they must kill at an immense distance, but they forget all about the spread of large shot. Their owners are constantly wounding, frightening, and driving away the fowl on which an

expert gunner would have done good execution with his smaller but far handier weapon.

A double 12-bore gun of $7\frac{1}{2}$ lbs., carrying a charge of $3\frac{1}{4}$ drs. of powder and $1\frac{1}{4}$ oz. of No. 4 shot, is as useful a gun as any shore-shooter can want, and powerful enough for anything from a sandpiper to a swan. With such a gun we have often killed a dozen and more duck and widgeon at a shot, and at other times fired at a single plover when with a larger gun we should have grudged the charge.

Before concluding the chapter we will give a few records of wildfowl shooting which may interest our readers. Some of the best private wildfowl shooting in England is that of Lord Walsingham, near Thetford, in Norfolk, who has on his estate two large meres frequented by wildfowl, where under certain conditions of wind and weather many thousands of these birds may be seen on the water at one time. As an example of how good and varied is the shooting at Stanford Mere the following bags may be mentioned. All are purely wild birds, none being ever fed or brought up by hand:—

Dec. 18, 1878. One gun (Lord Walsingham):—10 pheasants, 1 hare, 2 woodcocks, 5 snipes, 1 goosander, 1 golden eye, 7 widgeon, 18 pochards, 48 wild ducks, 1 gadwall, 10 tufted ducks, 2 shovellers, 1 smew, 8 teal, 5 wood pigeons, 13 various (coots and moorhens). Total wildfowl, 117.

Dec. 23, 1878. One gun (Lord Walsingham):—1 woodcock, 2 snipe, 63 duck, 13 teal, 6 wood pigeons, 1 wild goose, 9 various. Total wildfowl, 89.

Jan. 30, 1879. Two guns (Sir T. Thornhill, Bt., and Lord Walsingham):—3 pheasants, 1 rabbit, 5 snipe, 101 wildfowl (i.e. ducks, widgeon, tufted ducks, and pochards), 29 teal, 6 various. Total wildfowl, 141

Dec. 9, 1879. (Lord Walsingham):—1 pheasant, 1 partridge, 8 snipe, 83 wildfowl (i.e. wild ducks, widgeon, gadwall, and shovellers), 51 teal, two swans. Total wildfowl, 144.

Jan. 24, 1884. (Lord Walsingham):—6 pheasants, 2 partridges, 5 rabbits, 2 snipe, 64 ducks (these were all common wild duck but three), 30 teal, 4 various. Total wildfowl, 100.

On Monday, Jan. 26, 1885, Lord Walsingham and Lord

Ormathwaite shot at Merton in one day 90 wild ducks, 11 gadwall, 1 pintail, 5 pochards, 3 shovellers, 18 tufted ducks, 28 teal, 1 bittern, 2 snipe, 4 coots, 1 moorhen. Total wildfowl, 164.

The duck shooting at Lord Malmesbury's, at Heron Court, near Christchurch, in Hampshire, is also noted for its excellence. In 1870 three guns killed 166 teal in a single day there.

Very good wildfowl shooting is obtained by H.R.H. the Prince of Wales at Sandringham, by Lord Ilchester at Abbotsbury in Dorsetshire, and Lord Leicester at Holkham in Norfolk, some records of which latter we here give.

Wildfowl Shooting at Holkham.

1860.		
Dec. 24	Hon. E. Coke	} 29 wild geese
	Sir A. Macdonald	
	Hon. Col. Coke	
Dec. 26	Hon. H. Coke	} 44 "
	Hon. E. Coke	
	Sir A. Macdonald	
	Hon. Col. Coke	
Dec. 27	Hon. E. Coke	} 23 "
	Hon. H. Coke	
	Sir A. Macdonald	
	Lord Leicester	
	Hon. Col. Coke	

138 wild geese killed in 1860.

1862.		
Dec. 21	Lord Leicester	{ 73 ducks
		36 teal
		2 widgeon
	Total	111

1865.			
Feb. 8	Mr. Powell	} 75 ducks	
	Lord Leicester		
			15 teal
			27 widgeon
			2 golden-eyes
		1 goosander	
		1 pochard	
	Total	121	

SHOOTING.

Mar. 13	Mr. Powell . . .	}	2 snipe
	Lord Leicester . . .		46 ducks
			11 teal
			1 widgeon
	Total . . .		<u>1</u> pochard
			61

1866.

Feb. 28	Lord Leicester . . .	}	1 snipe
			71 ducks
			24 teal
			2 widgeon
	Total . . .		<u>98</u>

1870.

Dec. 26	Mr. Powell . . .	}	58 wild geese ¹
	Lord Powerscourt . . .		1 curlew
	Lord Leicester . . .		3 ducks
	Hon. Col. Coke . . .		1 snipe
	Lord Coke . . .		<u>63</u>
	Total . . .		63

Dec. 28	Mr. Posnett . . .	}	34 wild geese
	Mr. Powell . . .		3 Canada geese
	Lord Powerscourt . . .		1 Bernacle goose
	Lord Leicester . . .		
	Hon. Col. Coke . . .		
	Lord Coke . . .		<u>38</u>
	Keepers . . .		38
	Total . . .		38

115 wild geese shot in 1870.

1873.

Feb. 12	Lord Leicester . . .	}	64 ducks
			20 teal
			6 wild geese
			2 Canada geese
	Total . . .		<u>92</u>

¹ The only other place we know of in our Islands where wild geese are obtained with a shoulder gun in such numbers as at Holkham is near Berkeley Castle, in Gloucestershire (Lord Fitzhardinge's), not far from the banks of

1876.

Feb. 7	Lord Leicester . . .	}	1 snipe
	Lord Coke . . .		80 ducks
			7 teal
	Total . . .		<u>89</u>
			1 widgeon

1881.

Jan. 7	Col. Hon. W. Coke . . .	18 wild geese
	Lord Leicester . . .	<u>7</u> "
	Total . . .	25

76 wild geese shot by Lord Leicester and the Hon. Colonel Coke between January 13 and January 26, 1881.

In Ireland, Lord Castletown has first-rate duck shooting on his marshes (one of which alone consists of 3,000 acres of water and fen) near Abbeyleix, in Queen's County. Upwards of a hundred wild duck have often been shot here in a morning's fighting.

Having now given some notes concerning wildfowling in the British Islands, we add some on the sport abroad. We are indebted for these to the Duke of Sermoneta.

These records are taken from the Duke's game-book, and represent the best individual bags of duck made at Fogliano, in the Pontine marshes in Italy.

1873.

		Wildfowl
Dec. 13	Mr. L. Wilbraham	103
" 27	Duke of Sermoneta	156
" —	Lord Lindsay	120
" —	Duke of Sermoneta	<u>119</u>
	Total for four days	498

the Severn. Here 45, and on another occasion 44, wild geese were killed in a day, the larger bag being obtained during the great snowstorm of 1881. The geese chiefly shot by Lord Fitzhardinge are the greylag, pink-footed, and white-fronted. The geese killed at Holkham usually are pink-footed, though now and then white-fronted are obtained.

SHOOTING.

1874.

		Wildfowl
Jan. 17	Duke of Sermoneta	180
„ 24	Sir Augustus Paget	196
„ —	Prince Odescalchi	244 ¹
Feb. 1	Duke of Sermoneta	180
„ 7	Prince Odescalchi	197
„ —	Duke of Sermoneta	132
„ —	„ „	<u>200</u>
	Total for seven days	1,329

1879.

Dec. 4th, 5th, and 6th, two guns obtained in these three days 658

The Duke killed 214 birds to his own gun on Dec. 5th.

The marshes were shot on five other occasions during this month by one gun each day, the total being 891

and the result of the eight days' sport 1,549

Sir Augustus Paget scored 178 birds on Dec. 28th.

1880.

In four days this year, Jan. 3rd, 10th, 21st, and 23rd, Prince Odescalchi and the Duke of Sermoneta shooting on different days obtained 615

The Duke bagged on Jan. 10th 178 birds.

1881.

In this year the marshes were only visited on one occasion, when the Duke of Sermoneta killed 172

1883.

Dec. 17	The Duke of Sermoneta	107
„ 22	Prince Odescalchi	100
„ 31	Duke of Sermoneta	<u>212</u>

Total for three days 419

In 1884 the Duke killed 149 birds in a day, and on Jan. 9, 1886, Duke Grazioli 106.

¹ The largest bag made by one gun.

The Duke of Sermoneta informs us that under the head of wildfowl nearly twenty different species of wild duck are included, but that generally about two-thirds of the birds obtained are common wild duck.

The shooting is usually carried on at daybreak, during the morning flight, the sportsmen being posted in large tubs sunk in the water on those parts of the marsh most frequented by the wild duck.

Besides duck these marshes afford admirable coot shooting, as, for example, in 1884 the Duke of Sermoneta and his friends bagged as many as 2,226 in one day.

The coots are driven backwards and forwards by a line of boats, and as the birds fly wilder and faster as they become more and more alarmed, they offer the gunners shots that require considerable skill.

In all cases the numbers recorded represent only birds actually brought home. Owing to the nature of the marsh, it is nearly impossible to retrieve any bird which is not quite dead, and winged birds are almost invariably lost.

R. P. G.

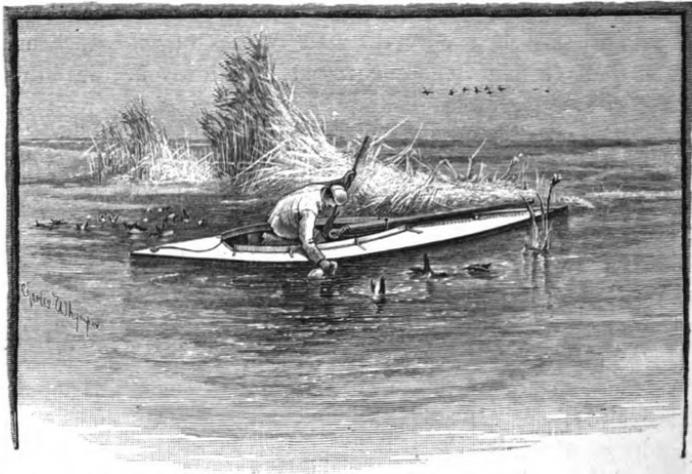

After a shot with the swivel gun.

CHAPTER XIII.

PUNTING, OR WILDFOWL SHOOTING AFLOAT.

PUNTING is the cream of wildfowl shooting, the favourite sport of all men who love the pursuit of wild birds on the coast, and who have once enjoyed it. It is almost entirely confined to the tide, there being but little of this kind of shooting on fresh waters, except to a small extent on the Norfolk Broads, and on a few of the Irish and Scotch lakes.

It is a sport almost unknown to dwellers inland, who speak, and air their supposed knowledge, of it, in the most absurd manner, either from hearsay, or from the perusal of books and papers equally at fault.

One of the commonest ideas connected with this grand branch of sport is 'that it is slaughter, that there is no skill required, and that anybody can go out and kill wildfowl if he only has a big gun and a punt.' Now, wildfowl shooting with punt

and big gun is without doubt one of the most arduous, one of the most exciting, as well as the most uncertain of sports. It also has a spice of danger about it which adds to its attractions. It is a sport at which a rich man can no more command success than can a poor one. It depends upon weather, luck, skill, experience, and a combination of favourable or adverse circumstances. To stalk in a punt a number of fowl, whether geese or duck, on broad shelterless waters, will often require the manœuvring of a general, the patience, silence, and cunning of an experienced deer-stalker, and the hardihood and pluck of a lifeboat crew, together with the cool watchful eye of its coxswain.

The chances are always, save on the rarest occasions, in favour of the birds and against the shooter. The latter may toil for days—nay, we have done so for weeks—without securing even one fairly good shot. He may be disappointed just as everything seems in his favour and a good chance assured him. A wildfowl shooter in his little craft with fowl about is like a huntsman with the hounds continually running and his fox in view, but his efforts are far less seldom rewarded with a kill.

We have known men, accustomed to tiger shooting, to elephant slaying, to stalking of every sort and kind, to salmon fishing, and to all the sports and most of the excitements of the world, admit that during the few minutes previous to drawing in shot of a vast assembly of wildfowl, with a big swivel gun cocked and ready before them, as they lay prone in the punt, their hearts seemed to beat louder than ever they did before. At such a moment an intense anxiety takes possession of the merest novice lest the birds should fly off before he can obtain a shot. He notes every suspicious occurrence, from the warning movements of the sentinel birds to the rising of the heads of the entire company before springing aloft.

He sees geese, duck, widgeon, and teal, and many other birds, as he never saw them before, swimming, washing, playing,

and calling within a hundred yards of him, and yet he has to steal along for another thirty or forty yards ere he can fire with any hope of success. He perhaps experiences the fact that there is 'many a slip between the cup and the lip' in fowling. The tide may meet him as he turns a corner, or a shot a long distance off come echoing over the waste of ooze, and alarm the fowl as though fired purposely to do so. The wind may change, or the birds may see his anxious attempts to get on closer terms with them. A score of various and provoking incidents may happen to prevent his getting a shot, however well he may have earned it, or however careful his judgment and actions may have been.

Perhaps he gets within shot, aims true, and then picks up his score or two of beautifully plumaged birds; but it must be observed that this is no easy matter, except under the most favourable conditions of wind and tide. After such a shot, a rest, a pull at his flask, and a look at the spoil, he vows that wildfowl shooting is about as hard and as exciting a sport as can be imagined.

If, when in shot, he misses, which is an extremely easy thing to do, it only makes him more anxious to succeed better next time, and his one fear is that he will not have another equally good chance. A sportsman once touched with the fever of wildfowl shooting afloat, or who has once seen or felt the charm of success in this fascinating and scientific sport, will never give it up so long as his strength will stand the exposure which it is necessary to undergo.

Let people talk nonsense on the subject; let them imagine that you row up in a boat to a flock (as they call it) of duck, lay down the oars, and then fire pounds of shot into the middle of them without any difficulty; that you wound them, that you are cruel, and so on and so forth. Such ideas do you no harm, and 'tis all the better that your friends should remain in their ignorance and not interfere with your sport, for there are more gunners than ducks now on parts of the coast. Smile courteously—do not attempt to enlighten them; it would take

half a day to do so, perhaps a week. Say that it is not so bad as they think ; send them some ducks ; ask if they have never read Colonel Hawker's book, the work of the most famous gunner that ever lived or wrote. But we must finish this rhapsody on shooting wildfowl and turn our attention to the practical details of

HOW TO SHOOT WILDFOWL WITH A PUNT AND SWIVEL-GUN.

All boats and skiffs suitable for wildfowl shooting are more or less flat on the floor ; they are usually pushed or punted up to fowl by means of a short pole, hence the name given them of ' punts ' or, better still, ' fowling punts,' in opposition to the fishing punt of the angler.

Almost all the big guns used in fowling punts turn on their balance, either by means of a swivel attached permanently to the barrel, or by being merely balanced in a crutch or loose swivel like the rowing spur of a boat—hence the name of ' swivel-gun.'

The wildfowl shooter who uses a punt and swivel-gun is known as a ' punter' or ' puntsman,' but he is sometimes called a ' big gunner,' or when seen afloat spoken of only as a ' gunner.'

His object is always the same, however difficult it may be of accomplishment—viz. to endeavour by lying out of sight in his low and white-coloured wildfowl punt to steal up by the use of small hand-paddles or other means to large numbers of wildfowl, and this he usually has to do on broad open waters without any shelter or assistance. When he considers that the birds are within range of his gun, he fires with more or less success.

It takes a puntsman years of patience and observation or the birds which he hopes to obtain, of the tides, of the weather, and many other matters, besides a thorough mastery of his craft, gun, and numerous appliances, ere he can attain a complete knowledge of this sport. Launch a novice at this kind of shooting on an estuary crowded with fowl, apparently

drifting quietly about in the distance, tame and unsuspecting, and give him every requisite of the most perfect kind ; he will not kill a bird, whatever degree of confidence he may have expressed, but he will fire off a stone of shot, gain some insight into his own ignorance, and return, if he be a sensible man, anxious to learn something of the A B C of what he so rashly regarded as a simple undertaking. Let us look at them. There they are !—quite a thousand scattered here and there—far out in the tideway, floating about hither and thither, some pulling asunder the drifting weed, many of them with their heads tucked under their wings.

But it is nothing of a shot ; you would scarcely get half-a-dozen, they are so spread about, though seen from shore and low down they appear such a long black line. No experienced gunner would disturb them for the sake of half a dozen, provided a rival was not at hand to do so. Even then he had better not join in, as the birds when driven away might come towards him and, alighting, offer him a favourable shot.

Do you see that small bunch of widgeon and teal—not more than a hundred in all? But how close they sit ! A shot at them would give twice the return of a rake into yonder straggling thousand.

And look ! on that point which the tide is just covering. That is more like a shot ! See ! it is alive with duck, widgeon, and teal, all crowding together, feeding on the dainty green weed which they love. Yes ; they know that it will soon be all under water, and as they are not diving duck they will have to wait till the next tide for another chance. The recent strong gale on shore has hustled the birds about and kept the tide above their best feeding grounds for a longer period than usual. They have not had so good a feed as they are having now for three days. Observe how anxious and hungry they are—scarcely a bird with his head up to keep a look-out.

Ah ! there come their enemies, like two white planks of

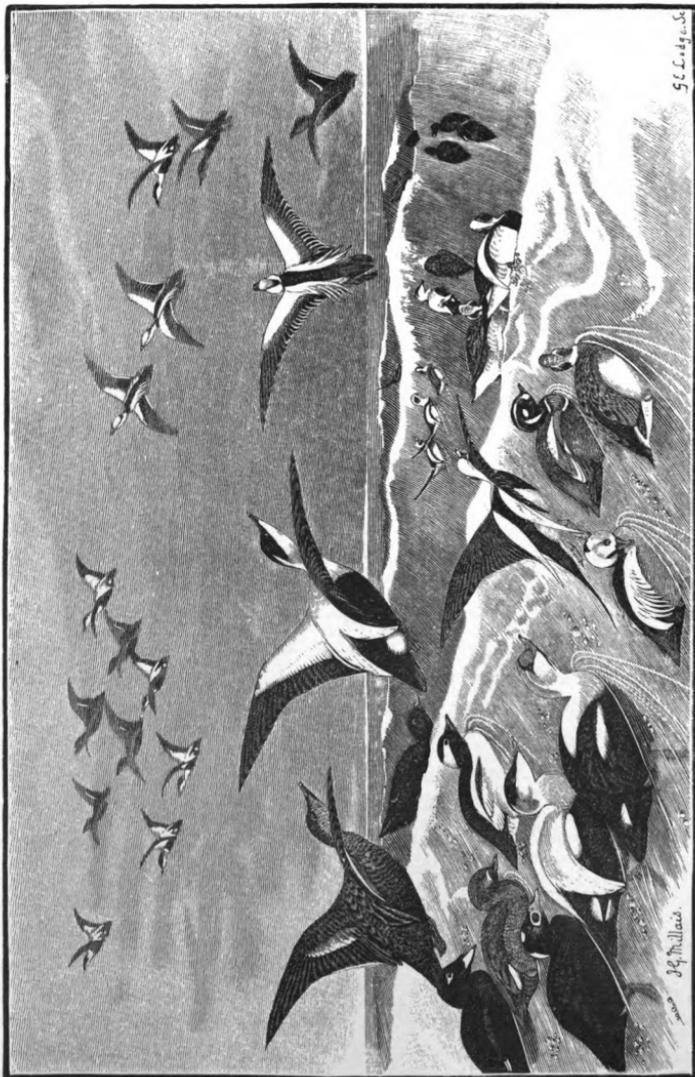

WILDFOWL AT SEA

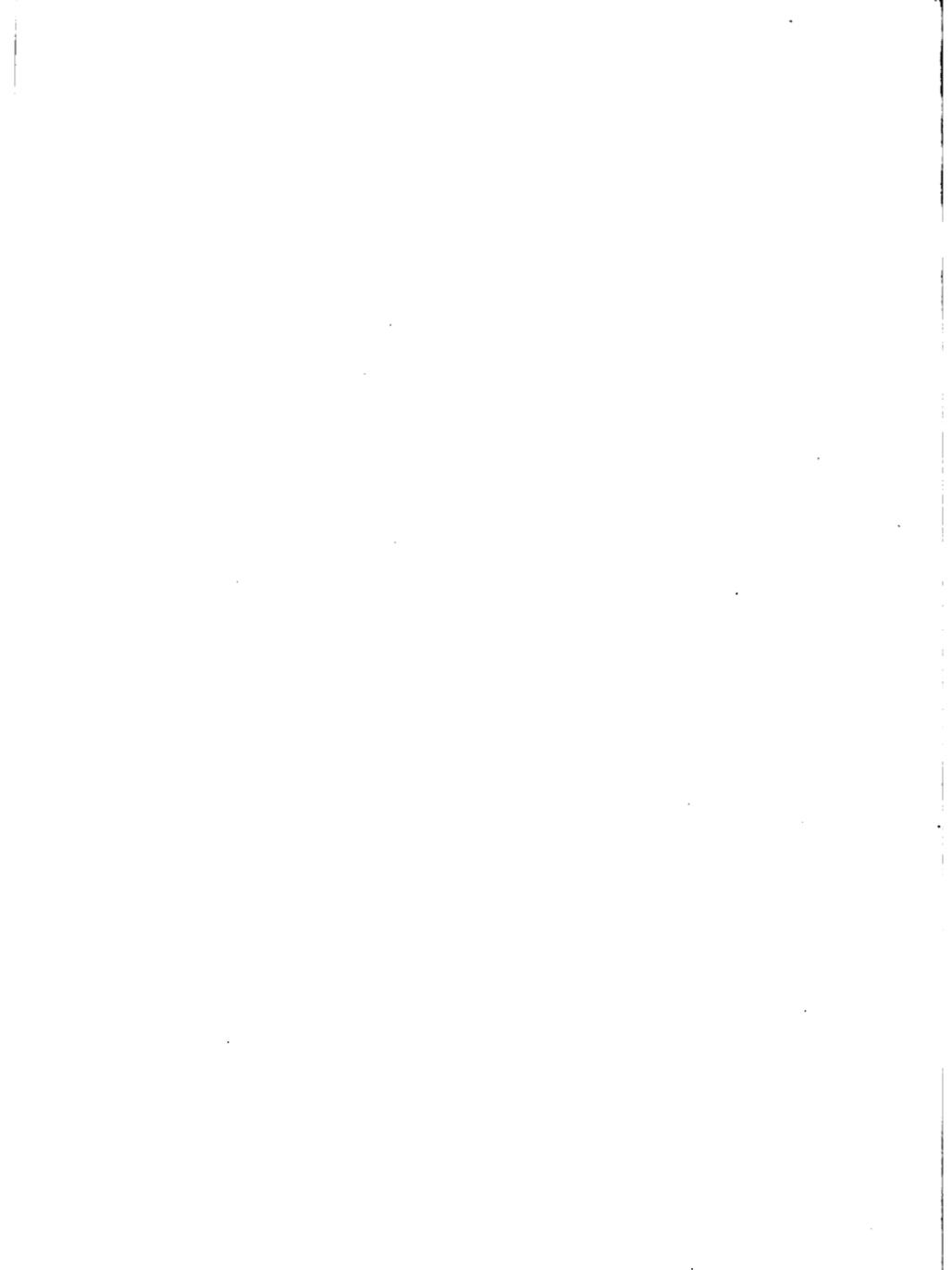

timber—not a motion visible, stealing, stealing nearer and nearer. What are they? Why, two punters of course, who have probably been watching these very birds for hours, each man lying hidden in his tiny craft. How close to the birds they appear! but they are not nearly so close as one would imagine from the shore; that short space between them which looks scarce fifty yards is fully one hundred and fifty.

Now they are drawing within shot, their fingers are itching to be at the triggers; but they will not fire till the birds have put up their heads, and until they get, if possible, within sixty yards, because close shooting means clean killing and no wounding. Now up they all rise in a cloud. What does the glass tell you?—that a number of them are on the point still. Doubtless this is so, but those are dead birds. The punters fired in first-rate style—the first man at the birds on the ground, the second just as they sprang aloft. Hand me the glass. Yes! they have no cripples, the leisurely movements of the gunners show this, but they have fully fifty fowl to divide, possibly sixty.

There are no men in the world at this moment who are in better temper and spirit than these two punters, and surely they have cause for congratulation.

Look! we shall see another shot yet; there go the brent geese. They were disturbed off the ooze higher up the bay by the last shot, and have pitched in the open water where it is a bit rough. But there are the fowlers to whom we spoke in the morning; their double punt will stand the sea out there—at all events they are going to have a try, for they are lying down. How low their craft looks, and how speedily she glides up to the brent! They are acting wisely, though you say that they are sheering away from the geese rather than towards them. They are making a *détour*, and will then come back *across* the wind at the birds and a little above them. The brent will surely rise against the wind, and so fly across the bows of the punt. Up they get, just as we said, and fly right across the muzzle of the big gun; ten or twelve of them dropping to its

discharge. What a clatter the others make as they wing off, as if remonstrating, scolding, and complaining of their ill-treatment !

Pop! pop! Yes, they have some wounded, for it was rather a long shot, and you can just hear the 'cripple-stoppers' (as their shoulder guns are called) at work.

We have now had a glimpse at what is known as single-handed and double-handed punting, two distinct methods of shooting, each equally favourable under suitable circumstances. We will first describe, as being the most general, single-handed punting. This method of shooting wildfowl is so called because it is carried on by one person, who, in a fowling punt, without aid from others, paddles and, in one way or another, shoots the fowl by himself. This system is therefore known as single-handed, to distinguish it from double-handed punting, as the latter implies two men in the same punt working and shooting in company. Single-handed punters are, as a rule, very ignorant of double-handed shooting, as the former is in far more general practice than the latter. They, in consequence, speak of *their* guns, punts, and paraphernalia as being the only successful ones for wildfowl shooting, and they are always ready to stand by their opinions and to condemn those of the double-handed shooters.

The question of double *versus* single handed punting is one that among wildfowl shooters, should both sides of the question be represented, is sure to give rise to fierce and unsatisfactory arguments. We can only say that we have had admirable sport in both double and single punts. Disputants over the question entirely forget that the punts which suit one estuary may be utterly unfit for another.

For example, narrow crank single punts are not adapted for use at sea or in wild open waters, and a sensible shooter would not employ one. On the other hand, a large double punt is unsuited for small creeks and overshot harbours, as to fire the much heavier gun it carries would be to waste a charge on the

small numbers of fowl that a single-handed shooter with his smaller gun would be content to fire at.

Single-handed punting is carried on and is much in vogue at places where fowl are few and shooters many, and this is right and proper.

A single gunner uses a comparatively small gun, firing from a half-pound to one pound of shot, and he would not grudge firing this charge at even three or four ducks, whilst a double-handed gunner with a large gun would not care to do so, his charge being so much more costly.

Single-handed punting is adapted for and effective on fairly sheltered waters, where a man alone in one of these small craft is safe from wave and wind. Double-handed is suited to unsheltered waters, where two men and a larger and better sea-board are required, and where there are fewer punters and more fowl.

The more numerous the birds the larger the gun required; a shot from a big gun disturbs them no more than a shot from one half the size, though the latter would kill far less fowl than the former. If a single fowler make a good shot, bringing down from twenty to thirty widgeon in a strong tideway or roughish water, and have a fair percentage of cripples, he has great difficulty in recovering some of them, for he is forced to row, shoot, and retrieve the spoil unassisted.

In a double punt one fowler rows after the dead and wounded whilst the other shoots and picks them up, and a bird is seldom lost. In a single punt, where one man has, as observed, to paddle, shoot, and steer, all at the same time, aiming with a swivel-gun is never easy, often very difficult. In a double punt one fowler paddles the craft up to the birds, and the other can take deliberate aim, as he has nothing else but the gun to attend to when approaching the fowl. Yet, as we have pointed out, single punts are suitable when fowl are not numerous. They are light and handy for one man to pull up and down the beach or to use on the water, and all their appointments are far less costly than in double

punts. A single-handed shooter, moreover, is independent, and can go out or not as he likes. When a double punt is employed the convenience and wishes of two men have to be consulted.

That a single-handed punt will approach nearer to shy fowl than a double-handed is, in our experience, a delusion. The former is perhaps faster, but then it will not float in such shallow water as will the larger punt, and this is indeed a drawback, as we have found to our cost, when an inch less draught would have assisted greatly towards procuring us a good shot. Of course there are double punts which are so large and cumbersome that they possess disadvantages from which a single punt is free ; but a light, well-built double, with its larger gun and more powerful crew, will prove as serviceable as a single punt in *any* water, and in such waters as are specially adapted to its use it will aid in bringing to bag almost double the number of birds.

Single-handed punters who have never seen good double-handed shooting vow that the latter mode is ineffective in comparison with their own. Nevertheless, we have been successful in a double punt against the best of their vaunted singles, and have many times got shots at fowl, in a double, after the single shooters had failed.

In a double punt the mode of progression is much more stealthy than in a single, and the propelling power, being so far aft, is well concealed from the wary birds ; besides, fowling afloat alone is a melancholy business ; it is pleasant to have with you a companion who is happy at your successes and sympathetic at your failures.

There is plenty of work, however, for everyone, whether in single or double handed shooting ; but remember there is nothing skilful in either system in the actual hard work—that is but exercise. The science of the sport comes into play when the gunners see the fowl and manœuvre to approach them. With the single gunner it is shown by the way he paddles, steers, and finally takes his shot ; with the double it is by the way the sculler manages and works the punt up to the

fowl, on the one hand ; on the other, by the way the gunner directs his assistant, plans the approach, and then takes the shot ; so that whatever kind of punt may be in use, each man has plenty of work, both mental and physical. It is a common and highly successful practice in some parts, where fowl are numerous, for two single-handed punters to set to the same birds, and to fire at the birds at the same moment, or as nearly so as possible, one shooter waiting for the gun of his companion to go off, or else first firing himself as a signal.

By acting thus, one gunner will shoot the birds on the ground or water, and the other will kill them on the wing.

We will now say something more to the point concerning the actual sport and the best way to obtain it, and as health is of such vital importance to a wild-fowl shooter we will mention this subject first.

It is most essential that a young fowler should study

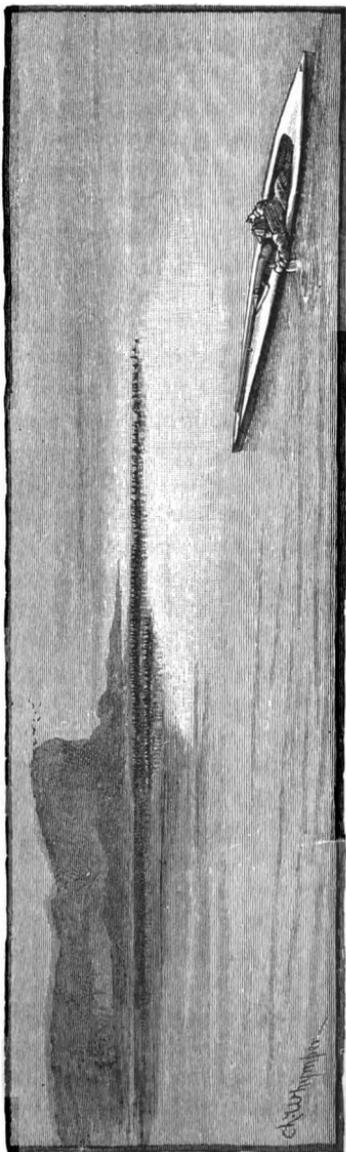

Single-handed punter paddling to a company of widgeon.

his health, and the first rule he should remember is to keep his feet dry. It is no use his fancying himself a fine hardy fellow, one who never takes cold, however wet his feet may be. It is not what he feels as a young man, it is what he will feel as a middle-aged one. Wet feet at twenty, though no ill effects be experienced at that age, mean rheumatism at forty, guns put by on the rack and boats laid up in sheds, when more careful men are still enjoying, and are long likely to enjoy, the wild sport of the coast.

To keep the feet warm and dry a thin pair of silk socks next the skin and a thick pair of worsted over them is a necessity, and then a pair of easy-fitting absolutely waterproof leather boots that reach well above the knee. Cow hide is admirable for these, as it is soft and pliable and dries quickly. India-rubber is at all times to be avoided, being unhealthy and unfit for use when fowling. As to clothes, wear grey flannel trousers, waistcoat and coat, the former buttoning round the ankles on account of the long boots. Always wear flannel next the skin, and let nothing in the shape of linen be put on. Two tight-fitting flannel vests and drawers give more warmth (and are easier by far to work in) than three sets of coats, waistcoats and trousers, because the former fit close to the skin, which the latter do not. A knitted fisherman's jersey with sleeves, made of soft wool, and worn over the waistcoat, is a wonderful preventive against cold. It is the object of a fowler at all times to wear as little as possible, so long as he has enough to keep him warm ; too many clothes will make a shooter clumsy in his movements, and greatly hinder him in his occupation of rowing and shooting.

All punting coats and waistcoats should fit high and tight round the neck, then a scarf or wrapper can be dispensed with, for keeping the throat warm by means of a comforter has a tendency to create cold when it is taken off. The punter's cap may be made of white flannel, with a peak and of precisely the same shape as a 'yachting cap.' On no account use a cap with a projection behind, or the latter will tip your head-gear

over your eyes just at the wrong moment when lying down in a punt and about to take a shot. For the sake of colour a white linen overall can be worn, one that can be washed as occasion requires. But flannel, flannel, flannel, by night and day, should be the fowler's dress afloat; he will then ward off the ill effects of wind and wet, amongst other ailments, and these form a combination which is the father of rheumatism and ague. As regards waterproofs, of course, these are a necessity in wet, and act the part of an extra coat in very cold weather. Nothing is so good in this line as seamen's oilskins, as they are so pliable.

In the matter of food a fowler should live well and treat himself generously, for we defy him to endure hard work and the severity of the elements on a poor diet.

If cold or shivering, on no account approach a fire. It is the very worst thing to do. Restore circulation by exercise, or by degrees in a fairly warm room. Hot or cold spirits are equally bad, hot soup or warm milk is excellent.

However early a fowler rises and sets out from a house or yacht, it is most essential that he should not do so on an empty stomach. Whatever it be, let him eat something on such occasions; a cup of milk and a slice of bread can be left ready for him the previous night. What is known as a good dinner is a bad dinner for a tired fowler if taken on his arrival home. Some light refreshment, such, for instance, as a cup of tea and a biscuit at first, and a regular meal later on, should be his rule.

So much for his clothes and his health, and now for his sport. We will suppose him afloat in his punt, with the luck of having fowl at hand.

Let him, when seeking sport :

1. Avoid following, or firing at, birds during high water, or even when the ooze beds are covered by the tide. There is great risk of driving the birds from their feeding grounds and making them wild and restless. If fowl are left in peace at high water, they will merely float about near or over the

beds of ooze they feed on when the tide is out. They then get a haunt, and a good shot at them will sooner or later be obtainable.

2. Do not endeavour to set up to wildfowl in a punt unless pretty sure you can float up in range, as the action consequent on struggling and pushing over a shallow will usually alarm the birds, when by waiting a short time the flowing tide might easily have permitted a near approach and a certain shot.

3. Shooting on the ebb tide is on nineteen out of twenty occasions a waste of time, and a loss of birds ; for the same birds might have been obtained on the flood, when there would probably be water to float nearly up to them. If fowl are left in peace on the ooze when it is uncovered by the ebb, they will often sleep and feed, and becoming quiet and confident in consequence, allow the punter to get in shot of them as he floats quickly up with the flood tide.

4. If fowl rise time after time just out of range, settle, and rise again every time they are set to, they are well on the alert. Do not fancy for a moment that because they pitch again not far distant they ignore your presence, or that they are but naturally restless and will in time settle down and afford a shot. Nothing of the kind. You might follow them all day till your arms ached, and yet obtain not even the remotest chance. It rather shows that if they were left alone for several hours they might quiet down, though this they would never do so long as your punt was within a couple of miles, or at all events in sight of them.

5. The harder it blows the better for punting, always provided your punt can live in the sea knocked up by the wind, and also that you can steer and shoot in it. If you can get near them, you will find all wildfowl unusually tame in a gale of wind, as they dislike riding it out in the tossing waves, and when on the ooze sit huddled together for mutual shelter from the blast that would otherwise ruffle their feathers.

6. The best hour to look for a shot is at dawn, that is, if

the feeding grounds which the fowl frequent are just being covered by the tide at that time. The birds, having been on the feed all night, are heavy and loth to take wing, especially so if, feeding over the last bit of ooze, they have no chance of finding more food till the next ebb again uncovers it.

7. The most favourable time to seek a shot by day is about an hour before low water. You will then most probably be at your shooting grounds at low water, and therefore ready to take a chance at fowl with the first of the flood, or at once to set at birds that may happen to be resting on the outermost edge of the ooze banks, before the tide, one way or the other, affects your approach.

8. It is the rule in most places that spring tides are the best for punting, and especially so when high water is at eleven o'clock in the day, as then there is a good chance of a shot both morning and evening. Low water at three o'clock is very suitable for afternoon shooting, high water at ten o'clock for early morning sport, or under a late moon.

9. Shooting by night is a hopeless undertaking, unless the moon be bright, the sky clear, and the weather still. It is also generally useless to try and shoot birds swimming by night. They should be found and fired at on the ooze.

The young fowler must give up all idea of seeing or approaching birds by night, except by going directly towards the light of the moon; in fact, he should get them between himself and the moon, and so in the rays of the latter; any other way of setting to fowl by night is a waste of time. If he come on the birds with the moon behind him, they will see his punt a couple of hundred yards distant and fly away, whilst he would not see them thirty yards off, even were they not to leave. He may hear birds calling all round him, some apparently within a few yards, but never a shot will he get, except at those in the bright reflection of the moon as he paddles towards that luminary.

It is not much use trying for fowl early in the night, as at that time they are spread all over their feeding grounds in open

order, like crows in a field, scarcely two being together, however numerous they may be collectively. About an hour before dawn, if the tide be a little over half flood, and the moon fairly bright, is the best hour for a night shot. The birds will by that time have gradually fed together and become packed as the tide surrounds both them and their food ; they are then favourably placed for a shot if they can be properly set to against the light of the moon, or towards the first glint of daylight in the sky. The most suitable shot to use at night is No. 2, as if a shot can then be got at all it is usually a pretty close one.

10. Distance is a great source of trouble to a young fowler. Seventy yards is a fair range for a punt gun, though sixty is a better and gives less cripples, but without considerable practice it is hard to judge accurately a distance of seventy yards across water, as to a novice a hundred yards appear no more than fifty or sixty. Practice alone makes perfect in this respect.

11. Above all things check any excitement, or undue anxiety when drawing in shot of fowl. If the shot is to be had, well and good ; if not, all the anxiety in your nature will not give it you. Excitement or anxiety usually means restless movements, such as peeping over the gunwale of the punt every few moments to see what the birds are doing. The slightest suspicious motion is instantly observed by wildfowl, and it is the fact that their suspicion is aroused that causes them to be instantly, and afterwards continually, watchful against approach, whereas if you had remained motionless as to your head and eyes, steadily paddling on meanwhile, the birds might not have taken alarm till too late for their safety.

12. If in shot, fire the *instant* the fowl raise their heads, and they will spring at the flash and meet the shot with their wings spread ; you can always paddle on so long as the birds have not stretched their necks.

13. You will have to act as quick as thought when you do fire:

one second too late and instead of a score birds you may have none. It may appear easy to send a charge fairly into a hundred birds at sixty yards, but it is not, and the most experienced fowlers often miss, especially if the punt (as is often the case) is dancing about on rippling water, tiny waves, maybe, but still quite large and lively enough to make aiming a gun eight feet long, as the gunner lies close in his punt, an uncertain business.

14. If you are fortunate enough to knock over some birds, row up to them as quickly as possible and keep your eyes on those that fly away for 'droppers' out of the pack, for there are sure to be some that fall at a distance if you made anything of a successful shot. Shoot the furthestmost cripples first and those near or on the shore next, using the shoulder gun for this purpose; the dead birds are comparatively safe, and can be picked up last of all.

Finally, let us repeat that wildfowl shooting with punt and gun is of all sports the most uncertain. The fowl may be visible in thousands, but that is no proof they are to be obtained, and we have usually done more execution on small numbers of birds than on large, for in large packs there are so many more bright peering eyes to see danger than where the fowl are less numerous. Do not therefore be disappointed at your ill luck at first. No amount of hard work or skill will command success in punting if the fates be against you, though there may be always the promise of good sport.

In the vista of years we remember our good fortune and are apt to forget the many, many, blank days we have had after wildfowl, for there are miserable failures as well as glorious successes in this kind of sport.

The sketch given on p. 256 of a shooting yacht represents the 'Watergeuse,' a Dutch 'schokker,' with lee board. She is 55 feet long, 16 feet beam, 3 feet 10 inches draught, and her crew consists of two men and a boy. She is admirably suited

for shallow waters, and is the property of our friend Captain G. Gould, of wildfowl-shooting fame, with whom we have shared excellent sport for a number of years.



We will now give some extracts, copied from our wildfowl-shooting diaries, which will serve to furnish examples and illustrations of the remarks that have been made, and to exhibit both sides of a wildfowl-shooter's life—the bright and the dismal.

We will take for choice ten days in January for three years, 1880, 1881, and 1885, as instances of the good and bad luck we have ourselves experienced on the coast of the British Islands.

PUNTING, OR WILDFOWL SHOOTING AFLOAT. 257

JANUARY, 1880.

Monday.—Too wild to stir out, though we have everything in readiness for shooting. Blowing a hurricane from the N.E. Glass very low.

Tuesday.—Ditto, ditto. Frost.

Wednesday.—Went out for a couple of hours at low water, returned wet to the skin with punt half-full of water. Calm evening; prospect of finer weather to-morrow.

Thursday.—Blowing as hard as ever, with heavy squalls of sleet; no chance of going out.

Friday.—Tides unsuitable, though weather favourable; out all day from dawn to dusk.

Saturday.—Ditto, ditto.

Monday.—Out at six. Fine weather, but wind in wrong direction for this shore, as the fowl cross over with a south-easterly wind. Home at five. Frost.

Tuesday.—Out at five. Wind changed to the north, and very favourable weather; a fresh breeze, but not too much. Saw a nice lot of fowl and might have got a shot, but that it came on suddenly to blow hard from the open water, and we had in consequence to hurry away home as fast as we could, getting well drenched and nearly swamped in doing so.

Wednesday.—Out at five. By the greatest chance we came suddenly round an island on a nice pack of widgeon, well settled. As they saw us and rose at once we scarcely had time to lie down in the punt and fire. A flying shot; 28 bagged. The first bit of luck for nine days. Home at 4.30.

Thursday.—As it was high water at dawn, we did not go out till one o'clock. Found a splendid pack of widgeon, and were getting nicely in shot of them when a large gull dashed at them, and put them all up just out of shot. They pitched again about two miles distant, but it was too late and too wild an evening to follow them with safety.

JANUARY, 1881.

Monday.—Hard at work all the morning getting a new breeching-rope on the gun, and stopping leaks in the punt caused by ice last week. Hard frost.

Tuesday.—Just come on board the yacht for breakfast. Been out all night and since three yesterday afternoon. Grand weather

and sport ; fowl on all sides in great numbers. Cold bitter, but most intense just before dawn. Paddles, oars, guns, movables, frozen tight to each other or to what they rested on. The only chance of thawing my trigger-hand was now and then to shove it under the wing of a fresh-killed bird or between a couple. Fired four shots. Brought in :—

Widgeon	58
Teal	27
Wild ducks	21
Bean geese	16
Total	<u>122</u>

Wednesday.—Come on board to dinner ; left the yacht early this morning. Snowed hard all day ; bright sky since dusk. Thank heaven, no sign of a thaw, or of the weather breaking up yet ! Frost has now lasted with unexampled severity nearly three weeks. Fowlers higher up hemmed in by ice, poor fellows ! Birds all down here with me in the open. A great many strings of swans flying across sky, heading south and south-west. Cold at night 'perishing,' but sport by day and night superb. Great destruction of small land birds, hundreds of them drifting dead along shore for the crows and gulls to squabble over. Fired five shots : brought in :—

Widgeon	72
Wild ducks	18
Pintail	9
Teal	22
Brent geese	7
Whoopers	5
Total	<u>133</u>

Thursday.—Out by dawn. Fired four shots, one a very good one which bagged 47 widgeon. Frost. Brought in :—

Widgeon	89
Teal	9
Pintail	7
Total	<u>105</u>

Friday.—Birds becoming very wild. Another fowler has appeared, having brought his punt on a cart from up the river ; but I hear he has so strained her in doing so that she cannot be used till repaired,

PUNTING, OR WILDFOWL SHOOTING AFLOAT. 259

Saturday.—Out by dawn, in a dense fog, frost as hard as ever ; weather cleared at three o'clock, obtained one capital flying-shot at teal and bagged 33, and another at widgeon. Brought in :—

Teal	33
Widgeon	27
Total	<u>60</u>

Monday.—A day of misfortunes. We set up to a fine pack of widgeon and duck intermixed, at daylight, quietly sleeping on the edge of the ooze. Just before paddling in shot a gunner on shore fired at a number of small birds, and away went the pack out to sea. We should otherwise certainly have bagged seventy or eighty.

In the evening we came across another fine pack of birds, all widgeon this time. We went hard aground just out of shot on the only shallow for miles, and in our struggles to push off made some small noise which frightened the birds away as a matter of course. Hard frost.

Tuesday.—A really good day, fired three shots and bagged

Widgeon	45
Teal	33
Ducks	11
Total	<u>89</u>

Out at six, home at five.

Wednesday.—Blowing too hard to go out, signs of a thaw, wind veering to south.

Thursday.—A thaw and raining, wind south, birds tame ; they no doubt fed ravenously last night, as the ice that covered their feeding grounds has broken up and drifted out to sea. Made one very good shot and bagged 56 widgeon. As good a ten days' shooting as ever fell to my lot in the British Islands.

JANUARY, 1885.

Monday.—No fowl about, and whole place spoiled for shooting by railway trains, steamers, and shore shooters, besides this abominably fine summer-like weather.

Tuesday.—Out from dawn to dusk, and returned soaked to the skin without a bird ; saw but a score at most. We leave here to-morrow in disgust, after a week's hard work without a shot.

Wednesday.—Arrived at — to-day, but too late to go out shooting.

Thursday.—Out all day in half a gale of wind, and driving squalls of sleet. Saw an immense pack of widgeon on the ooze at low water, driven on shore by the bad weather at sea. Could not get anywhere near them.

Friday.—Too rough for aiming or we should have killed upwards of a hundred widgeon to-day. We set up to some splendid packs sitting as close as they could stick, but though we twice approached well within shot, the rough sea made straight aiming an impossibility. So we did not fire a shot.

Saturday.—A fine and perfectly calm day, and consequently (as usual in such weather) all the widgeon and ducks flew out before dawn into the sea, and passed the day drifting about, scattered and unapproachable, miles away from the shore.

Monday.—Very calm. Out at five, in the hopes of obtaining a shot before the birds left for the open water as they did yesterday. We should have certainly got a good shot but that some curlew that were between us and the widgeon gave the alarm and spoilt our chance at the fowl. Followed the birds at sea all day to no good; lost our way through fog setting in, and did not reach home till twelve midnight, when everyone had given us up as drowned.

Tuesday.—Weather improving, hard frost set in early this morning. Out at six. At low water we set up to a grand pack of quite a thousand widgeon packed as close as they could sit on a point of sand; but as we were forced to turn a corner of rock broadside on to them, they saw us, and rose out of shot. We never saw a finer shot at home or abroad, and could we but have approached them some sixty yards nearer we should assuredly have bagged 80 to 100, possibly more, as there was at least a half acre of birds, and sitting so close that one could scarce be distinguished from another. Walked home by six. Raining and blowing hard again, and obliged to anchor punt and all gear in her in a creek, too rough to bring her into the harbour.

Wednesday.—My last day this season. Walked six miles to the punt and got aboard her by dawn, found her half-full of water, the effects of heavy rain and rough anchorage; everything in a dreadful state of dirt and slop. Took us an hour to clear up. Saw a fine pack of widgeon at sea being set to by a local punter. They rose without being fired at by him, and pitched half a mile from us out of sight in the creek we were anchored in. Lay down at once

PUNTING, OR WILDFOWL SHOOTING AFLOAT. 261

without pulling on my boots, which I had taken off to empty of water and left on the sand to dry. Drifted with the last of the ebb right down to the birds, which being round a point of ooze did not see us till we were within shot. Bagged sixty, a piece of good luck at last which we deserved after so many blank days. Lost my boots—swept away by the tide.

We have now given some idea of good and bad sport, and the uncertainty of punting—an uncertainty, it is true, that adds to the charm of such shooting, though sometimes it is hard to bear.

Before closing this chapter we cannot omit some mention of the extraordinary punting feats of Lord Londesborough on the Nile.

Lord Londesborough's total bag of birds to his own gun between Saturday, December 21, 1861, and March 19, 1862, consisted of:—

Coots	256	Teal	22
Quails	3	Pintail	162
Pigeons	3,283	Flamingoes	53
Pelicans	9	Curlew, plover, &c.	181
Geese	1,533	Heron, storks, &c.	113
Wild ducks	491	Miscellaneous	160
Widgeon	209	Total	6,475

Note.—1,514 of the geese were shot from December 21 to March 1.

The bag of wild geese from December 13, 1862, to February 11, 1863, amounted to 2,288, and the total head killed for the season from December 1 to March 12, not counting a few birds shot in November, was as follows:—

Coots	160	Widgeon	181
Pigeons	5,223	Teal	208
Quails	7	Pintail	130
Gatta	1	Curlew and plover	251
Pelicans	39	Flamingoes	25
Wild geese	2,294	Storks, herons, &c.	98
Wild ducks	777	Miscellaneous	330
		Total	9,724

The best days' shooting were as under :—

		Total
Jan. 6, 1862.	5 pigeons, 102 geese, 23 ducks, 4 pintails .	134
„ 27 „	330 pigeons, 39 geese, 3 ducks, 4 teal .	376
Feb. 3 „	358 pigeons, 91 geese	449
„ 10 „	10 pigeons, 154 geese, 2 widgeon, 1 pintail, 10 various	177
„ 12 „	1 pigeon, 90 geese, 11 widgeon	102
Dec. 17 „	370 pigeons	370
Jan. 1, 1863.	176 geese, 1 duck	177
„ 9 „	89 geese, 2 ducks	91
„ 20 „	570 pigeons, 17 geese, 5 ducks	592
„ 28 „	169 pigeons, 91 geese	260
Feb. 7 „	132 geese, 26 ducks, 18 widgeon	176
„ 9 „	52 pigeons, 166 geese, 61 ducks, 4 widgeon, 1 teal, 6 pintail	290

The artillery used by Lord Londesborough to obtain these immense totals consisted of a single-barrelled swivel-gun (with a flint lock) that fired only one pound of shot at a discharge. Lord Londesborough tells us that the geese were always killed between ten and four o'clock. Regularly at ten the birds used to arrive, and punctually at four they left again for their inland haunts. 64 geese was the result of the most successful shot at these birds.

The pigeons were all shot by Lord Londesborough himself with 12-bore guns, as the birds flew home to roost in the evening, usually with a strong North wind in their favour, the shooter standing under the shelter of palm trees. It will be seen that one afternoon 570 pigeons were accounted for, and on other occasions 370, 358, and 330.

R. P. G.

CHAPTER XIV.

FOWLING PUNTS : HOW TO BUILD AND USE THEM.

SINGLE- AND DOUBLE-HANDED PUNTS.

SINGLE punts are of different sizes, very narrow or of larger dimensions. The narrow craft is in much more common use than the larger and safer build, as it is better adapted for shooting very shy fowl, and handier and quicker to manage in safe waters. It is propelled by paddles worked over its sides, one in each hand of the fowler, and it therefore requires to be narrow in beam, or the shooter could not reach his arms across the decks to use the paddles, and so drive his punt along to the fowl (see pages 249 and 267, fig. 1). The other description of punt is propelled by means of an oar sculled in a spur near the stern, or, if in shallow water, is shoved along by the gunner pushing with a short pole (p. 267, fig. 2). As this punt, unlike the former, is not worked by paddling over each side, it need not be so narrow. It is in consequence safer, has more room on board, and can carry a heavier gun, besides being from its larger size a better sea-boat, and so able to follow fowl into wider waters than a smaller craft could venture upon ; but withal it is not so quickly and easily worked as the other. Both these punts, when not actually approaching birds by paddling, sculling, or poling, can be rowed about in search of sport like ordinary skiffs.

The following dimensions and directions relating to fowling punts are the result of our own experience, as well as of that of the best fowlers of the day.

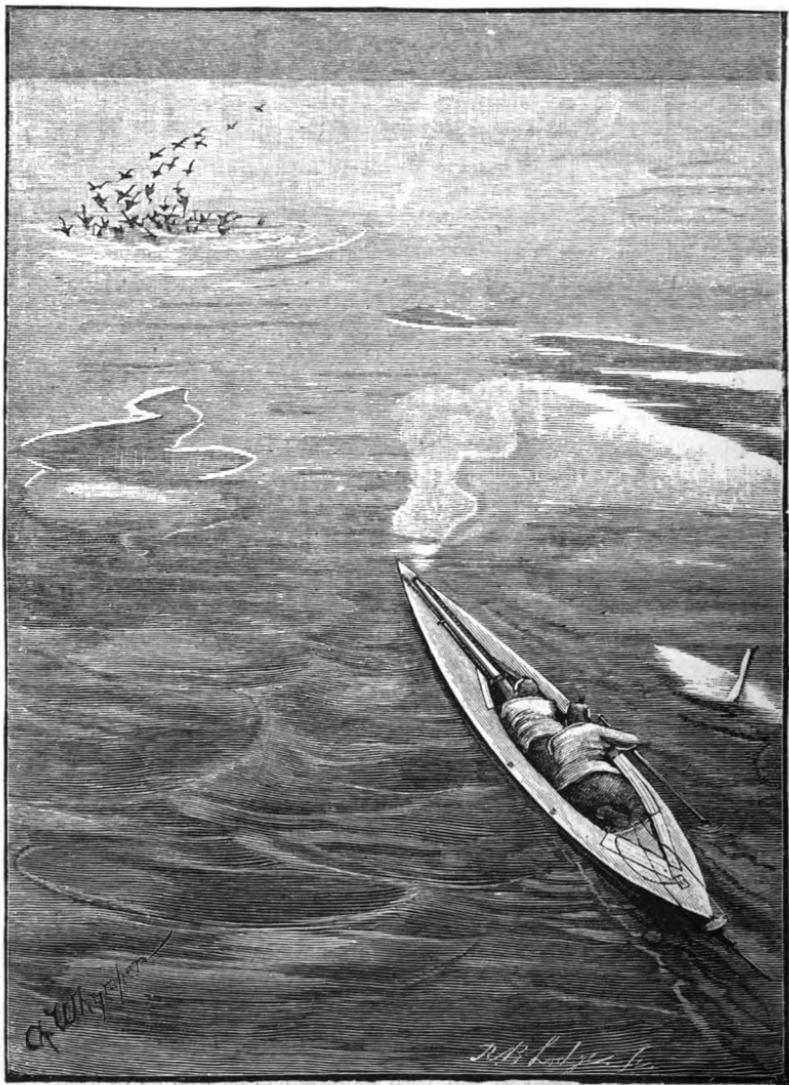

'A Shot in the Shallows.'

A SINGLE-HANDED PUNT FOR PADDLING TO FOWL (FIG. I, PAGE 267), TO CARRY A SWIVEL-GUN OF FROM 80 LBS. TO 112 LBS. WEIGHT AND A MAN OF ABOUT 12 STONE, MAY BE:—

	ft.	in.
Total length	18	2
Length on floor	17	3
Extreme width of floor	2	8
„ „ across decks	3	0
Height of stem	0	5
„ stern	0	8
Length of fore-deck	7	6
„ after-deck	4	0
Greatest width of cockpit	2	0
Width of side decks opposite openings for paddling	0	6
Each side flared out at most	0	2
Round of deck at gunbeam	0	3
Coaming forward	0	3
„ aft	0	2 $\frac{3}{4}$
Substance of	0	$\frac{3}{8}$
Spring on floor fore and aft	0	2
Round, across, or athwartships	0	$\frac{3}{4}$

Floor timbers 1 foot apart, and a pair of oak knees ($\frac{1}{2}$ inch to $\frac{5}{8}$ inch thick) to each alternate timber.

Floor timbers to be of elm, 1 inch wide, $\frac{3}{4}$ inch deep.

Four after and six fore deck rafters, 1 inch on surface by 1 $\frac{1}{4}$ inch deep.

	in.	
Floor planks	$\frac{5}{8}$	yellow pine
Sides	$\frac{1}{2}$	elm
Decks	$\frac{3}{8}$	fir

For a gun of not more than 80 lbs. weight this craft may be built: over all, 17 feet; on floor, 16 feet 3 inches; all else the same as above.

If a very fast punt of this class be required for an estuary where there is much competition, and at the same time sheltered water, with strong tides, and fowl scarce and shy, she may be built still lighter and smaller. A punt adapted to such circumstances should carry a gun not larger than from 60 to 70 lbs. weight. Her dimensions may then be:—

	ft.	in.
Total length	17	5
On floor	16	8
Floor at widest	2	6
Across decks	2	10
Height of stem	0	5
„ stern	0	7 $\frac{1}{2}$
Round of gunbeam	0	2 $\frac{1}{2}$
Coaming forward	0	3
„ aft	0	2 $\frac{3}{4}$

Floor timbers of oak, 10 inches apart, $\frac{3}{4}$ inch square.

A pair of knees to each other one, of oak and $\frac{1}{2}$ inch thick.

Deck rafters, $\frac{3}{4}$ inch square.

Decks, $\frac{1}{2}$ inch thick.

Floor planks, $\frac{1}{2}$ inch pine, or $\frac{3}{8}$ inch elm.

Sides, $\frac{3}{8}$ inch elm.

When setting up to fowl in this kind of punt (fig. 1) the fowler lies face downwards, his chest supported by the rowing cushion, or a smaller one made for the purpose. He reaches his arms through the parts of the coaming that fold down or lift out for the purpose, and drives the punt through the water with his small hand-paddles, which, keeping under water, he feathers forward after every stroke.

In shallows he pushes with them edgeways like sticks, if the ground be hard ; if soft, he uses them as in deep water. Within shot and about to fire he drops the paddles, which are secured to the gunwalè by cords to their handles, or he lays them quietly on the side-decks.

He can, if fowl are tame, leave hold of one paddle and move nearer in shot with the other. One hand is then at liberty to fire the gun in a moment, or to shift its elevation if necessary as he draws in shot.

At other times—that is, when not in the act of approaching birds or ‘setting to fowl,’ as it is called—the shooter may pull his craft stern first or push her along stem first with his oars, till he sees fowl, and lies down to approach them with his hand-paddles as before described (for cut of paddles see p. 294-5).

When moving cautiously along shore or channels in search

FIG. 1.

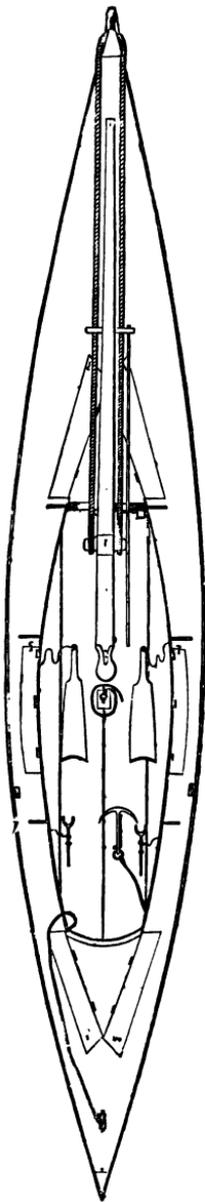
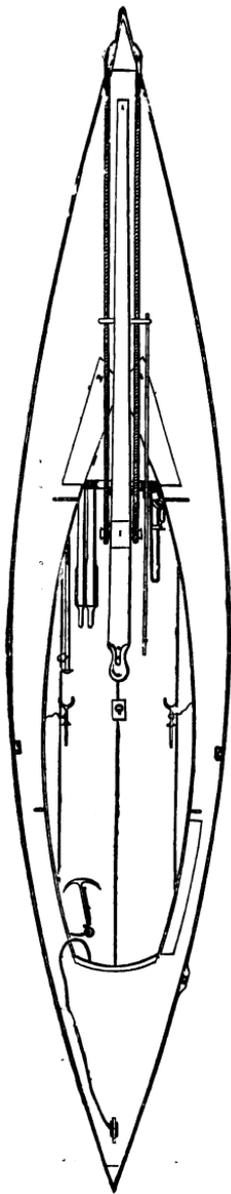

FIG. 2.



Single-handed fowling punt. Scale, $\frac{1}{4}$ inch to the foot.

of sport, the shooter can ply a long single, or a double canoe paddle, as he sits on the after-deck (p. 294).

A fowler will soon learn to decide from the look of the birds at what distance he should ship oars and lie down to approach them with his paddles—about one third of a mile usually; sometimes it is much more, at other times less, all depending upon the shyness of the fowl, as well as upon their position as regards shelter for stalking them.

A SINGLE-HANDED PUNT FOR SCULLING AND USING A SETTING-POLE, TO TAKE A GUN OF FROM 80 LBS. TO 120 LBS. WEIGHT (FIG. 2, PAGE 267):—

	ft.	in.
Total length	18	0
Length on floor	17	3
Extreme width on floor	2	9
Extreme width across decks	3	4
Height of stem	0	5½
„ stern	0	8
Length of fore-deck	7	3
„ after-deck	3	6
Greatest width of cockpit	2	2
Each side flared out at most	0	3½
Width of side decks at half length of cockpit	0	6½ each
Round of deck at gunbeam	0	3
Coaming forward (⅜ inch thick)	0	3 high
„ aft „ „	0	2½ „
Spring on floor, fore and aft	0	2½
Round athwartships or kammel	0	¾

Floor timbers, 14 inches apart, and a pair of elm knees (⅜ inch to ¾ inch thick) to each alternate one.

Floor timbers of elm, 1½ inch wide on surface by ¾ inch deep.

Three aft and five fore deck rafters, ¾ inch on surface, by 1½ inch deep.

	in.	
Floor planks	¾	yellow pine
Sides	a full ½	„ „
Decks	¾	„ „

For a gun not more than 100 lbs. this punt may be 2 feet 8 inches across floor, and 3 feet 2 inches over decks; all else the same as above.

For a small gun of from 70 to 80 lbs. she may be :—

	ft.	in.
Total length	17	6
Length on floor	16	9
Extreme width of floor	2	8
" " deck	3	2
Height of stem	0	5
" stern	0	8
Length of fore-deck	7	0
" after-deck	3	0
Round of gunbeam	0	3
Coaming forward	0	3½ high
" aft	0	2¼ "
Floor planks	0	$\frac{1}{8}$
Sides	0	$\frac{1}{8}$
Decks	0	$\frac{3}{8}$

When setting to fowl in this style of craft, the shooter lies partly on his left side, and with his right hand sculls an oar in the after starboard spur, through the opening in the coaming that hinges down flat or lifts out for the purpose.

In shallows he shoves along with a setting-pole (commonly called a stalking stick). When in shot he can lay his oar or pole down by bringing its handle inboard whilst he aims and fires the gun, using both his hands to do so. He can also continue sculling till the moment of firing the gun, which latter action he does with his left hand when in shot.

At other times, when on the look-out for sport, the shooter can row his punt stem or stern first, or sit on the after-deck and cruise leisurely about with a long paddle till he sees fowl, and lies down to approach them as described above.

DOUBLE-HANDED PUNTS.

DOUBLE-HANDED PUNT FOR PADDLING, SCULLING, OR USING A SET-POLE, TO TAKE A GUN OF FROM 130 LBS. TO 170 LBS.

WEIGHT :—

	ft.	in.
Total length	22	5
Length on floor	22	0
Greatest width of floor	3	2
" " across deck	3	11

DOUBLE-HANDED PUNT (*continued*)—

	ft.	in.
Height of stem	0	5½
„ stern	0	8
Length of fore-deck	8	3
„ after-deck	4	2
Greatest width of cockpit	2	6
Width of side decks at half length of cockpit	0	9 each
Each side flared out at most	0	4½
Round of deck at gunbeam	0	3¾
Coaming forward (½ inch thick)	0	4 high
„ aft „	0	3 „
Spring on floor, fore and aft	0	2½
Kammel or round athwartships	0	¾

Floor timbers 14 inches apart, and a pair of elm knees ($\frac{3}{4}$ inch to $\frac{7}{8}$ inch thick) to each alternate one.

Elm floor timbers, $1\frac{1}{2}$ inch on surface by 1 inch deep.

Three after and five fore-deck rafters, 1 inch on surface by $1\frac{1}{2}$ inch deep.

	in.
Floor planks	$\frac{3}{4}$ yellow pine
Sides	$\frac{5}{8}$ pine or elm
Decks	$\frac{7}{16}$ fir

For a gun not exceeding in weight 130 lbs. this craft may be built 9 inches shorter on floor and overhead, and both floor and deck 4 inches narrower; all else the same as given above.

The dimensions of a small double punt to take two fairly light men, and a gun of from 80 to 100 lbs.—a craft that even one man could, at a pinch, shove up to fowl by himself with a set-pole, and which two men could under any circumstances always use with complete success, provided they knew how to work it:—

	ft.	in.
Total length	21	0
Length of floor	20	5
Floor at widest	3	0
Width across deck	3	6
Height of stem	0	6
„ stern	0	7½
Length of fore-deck	7	6
Length of after-deck	3	3

SMALL DOUBLE-HANDED PUNT (*continued*)—

	ft.	in.
Round of gunbeam	0	3
Height of coaming forward	0	4
" " aft	0	3
Spring on floor	0	2
Round athwartships		$\frac{3}{4}$
Floor timbers of oak	$\frac{3}{4}$ in. square & 1 foot apart	
A pair of knees to each alternate one—	$\frac{5}{8}$ in. to	$\frac{3}{4}$ in. thick
Floor planks	0	$\frac{5}{8}$ elm
Sides	0	$\frac{1}{2}$ yellow pine
Decks	0	$\frac{3}{8}$ fir

When setting to fowl in a double punt the gunner lies face downwards, just clear of the gun, but well up to it, so that he can place his left hand on the short stock to depress it, and so elevate the muzzle for a flying shot, or instantly aim it to right or left as required. With his right hand he can then pull the trigger string, or run the gun-rest in or out, should it be necessary to do so, in order to alter the elevation of the gun. The second man (the puntsman) either lies on his left side, his feet and legs well under the after-deck, and sculls an oar in the after-starboard spur, or if the water be shallow pushes with a setting-pole.¹ A good method, unless a strong wind or tide be against him, is for him to lie down face upwards, with his head resting on the beam of the after-deck (which should be padded), and work the shorter of the two paddles shown in plan (see p. 294 for dimensions) over the starboard side of the punt through the opening in the coaming cut to unship for this purpose. The paddle-blade should be worked entirely under water (a waterproof sleeve being necessary) and feathered forward noiselessly and quickly after every stroke. If the puntsman meet a shallow, he can push with the paddle, without altering his position, and after a little practice he will be able to direct and turn the punt to an inch to suit the gunner, who will not then require a rudder.

A double punt by this last method can, under certain conditions of wind and water, be urged forward to fowl with more

¹ See picture on page 264, *A Shot in the Shallows.*



Scale $\frac{1}{4}$ inch to 1 foot.

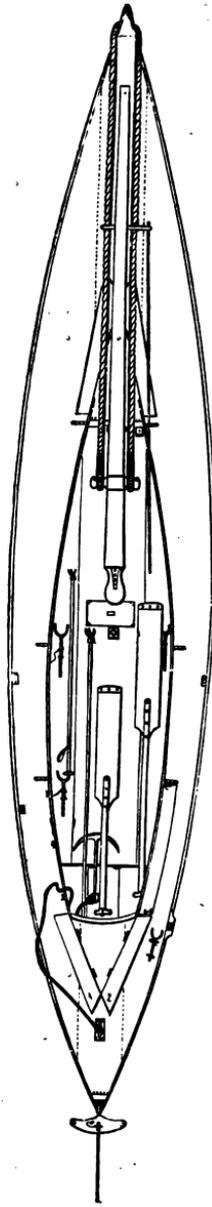
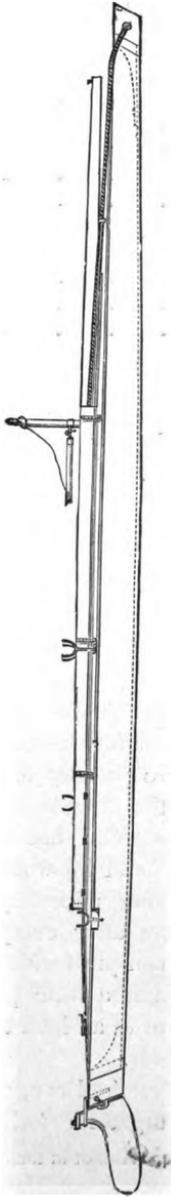

Double-handed Fowling Punt. Scale $\frac{1}{4}$ inch to 1 foot.

control, speed, and silence than if sculled with an oar, and with almost as much power as when pushed with a set-pole.

When moving about in search of sport the punt can be rowed by one man with sculls, or pulled by two, stem or stern first, as thought best. One man can in calm water send her along at a good pace with a long paddle, both fowlers being on the look-out for birds meanwhile.

After a shot the puntsman can often hurry the punt up to the cripples with a paddle as he sits on the after-deck ; but if wind and tide be strong he must get out his sculls and pull his best. In both cases it is the gunner who uses the cripple-stopper and picks up the spoil.

R. P. G.

CHAPTER XV.

SWIVEL-GUNS.

OF these there are two kinds, breechloaders and muzzle-loaders. The former are far preferable to the latter, provided they have the same advantages of lightness, of strength, and of hard shooting power. But, even at the present day, not many breechloading swivel-guns are made that can rival muzzle-loaders in these respects. The breechloaders are, with few exceptions, ponderous and very costly, as well as ungainly, and bad shooters.

Breechloading swivel-guns can be loaded very quickly compared with the time necessary for a muzzle-loader; but it must be borne in mind that quickness of loading, when only three or four shots at most are fired in a day, is no great advantage, whilst weight is a disadvantage, all fowlers complaining of it in a swivel-gun.

Muzzle-loading swivel-guns are cheap, handy, and simple; they are not likely to get out of order, and will stand any amount of rough work and knocking about. Breechloaders are usually most intricate pieces of mechanism, and require considerable care.

People who know nothing of the practice of punt shooting suppose that, because a swivel-gun can be charged at the breech, it is the only kind of weapon fit for the sport, and that a muzzle-loader is useless in comparison. It is a fallacy to think that, because shoulder guns are so vastly improved by being breechloaders, swivel-guns must of necessity be similarly valuable. The uses of the two guns are totally different, and no comparison is possible.

In land-game shooting a gun is required to be loaded at all times, ready for any shot that may be presented, and after firing is loaded instantly for the next chance. In punting the shots are slow, few, and deliberate; the shot is seen or expected long before it is taken, and after a discharge there is no necessity to load again hurriedly.

This is written, *not* to disparage breechloading swivel-guns, but to show that our old friends the muzzle-loaders are good enough to go a-fowling with, and to advise all shooters to use a good muzzle-loader in preference to a bad breechloader.

That *rara avis*, a good breechloader—one which meets all the requirements of punting—is a more convenient gun, in its ease of loading, than a muzzle-loader, but in nothing else.

A fowler who used at all times a breechloading swivel-gun would probably not kill a bird more than the man who always used a muzzle-loader, but the former would have least trouble, and charging his gun would probably take him two instead of five minutes. Once and again he might even be able to load a breechloader when a muzzle-loader, owing to rough water, could not be charged; but rough water and sport do not go hand in hand.

There are a few gunmakers who can turn out small breechloading swivel-guns fairly well. But they are usually costly and heavy pieces, and there is at most but one good principle to follow or example to go by in the matter of breechloading swivel-guns, though each maker has naturally a plan and pattern of his own.

The best swivel-guns we have come across are made by 'Holland,' of 98 New Bond Street, and they are the only makers we know who have been able to turn out a very large gun successfully, such a one as we have had in use, that fired 2 lbs. of shot comfortably, and only weighed 170 lbs. This gun is equal in weight, penetration, and general handiness to a muzzle-loader of the same weight in our possession, and had, of course, the advantages of loading at the breech. Yet at this moment

we do not fancy that there are half a dozen such guns in existence. Far the best system for a breechloading swivel-gun is the one that is exemplified in the cut here given of our famous double gun, a system of loading which, whether the weapon be single or double barrellled, makes a breechloader about as perfect in its formation as possible. The screw plug and the extractor being all in one piece, no special cartridges are required. As this big gun is a curiosity in its way and may be of general interest, we give some particulars of its shooting and mechanism, and may add that in actual practice it is a complete success.

Double-barrelled Punt Gun.—Bore, $1\frac{1}{2}$ in. ; weight, 200 lbs. ; length, 9 ft. 6 in. The recoil is taken up by a very neat apparatus, F ; and by a strong loop fixed to the barrel for taking a rope breeching, G. The gun was made to our designs and drawings, small improvements being added as they suggested themselves to the makers during construction. The mechanism of the lockwork is novel, and critics say extremely ingenious. With one trigger only, the right barrel may be fired without the left, or the left alone, or one fired after the other, or both practically together. The stock, which simply holds the lockwork, is attached by a hinge at the bottom of the barrels, and, when closed, is fastened in its position by a half-screw bolt, B. The barrels are connected by upper and lower ribs in the ordinary way, and all the exposed metal parts are nickel-plated and left dull. The screw breech extractors were invented for this gun by Messrs. Holland and patented by them. They are exceptionally strong and very simple. The novelty is in the revolving head, C ; this enables the screw breech to be unturned, and at the same time the cartridge case, D, is extracted without twisting it round, thus preventing the tearing off of its base. The extractors work so easily that they may be unturned with the finger and thumb only, even after firing the gun. A safety bolt, A, completes the gun.

We shot this gun on our own trial at Messrs. Holland's ground. It worked admirably in every respect. We fired many

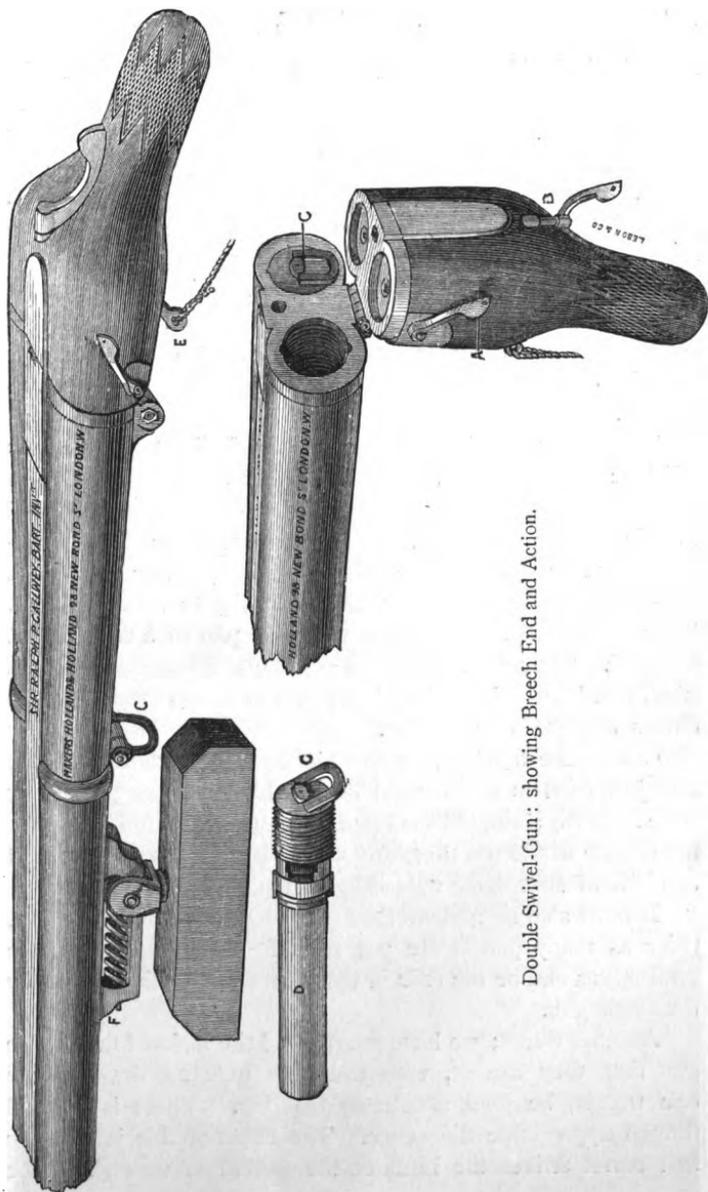

Double Swivel-Gun : showing Breech End and Action.

shots, both double and single, from a recoil frame built on the principle of a fowling punt. It consisted of a 14-in. square log of wood on four 6-in. wheels. A platform of boards was fixed on the log behind the gun to enable us to lie down and fire it. This is the first breechloading double gun ever made. Colonel Hawker's famous double gun was much the same size and shape, though slightly smaller, and was a muzzle-loader. We intend this gun for shooting abroad, where fowl are more plentiful than at home. For our British coasts we recommend a lighter gun for a smaller punt—one, for example, carrying $\frac{3}{4}$ lb. of shot in each barrel, and weighing from 100 lbs. to 120 lbs.

The theory, and indeed practice, of a double punt gun is as follows:—The barrels are placed parallel, the centre of each barrel being the same distance apart at both the breech and muzzle from each other. If both barrels are fired simultaneously at a mark the result is, two circles that overlap about one-third of their diameter at from sixty to seventy yards. Take instead of a bull's-eye the thickest part of a company of wildfowl. They will, therefore, get the extra amount of shot (that, too, being where the birds are the closest) caused by the circles eclipsing one another. The two circles being side by side also make a longer or more drawn-out pattern, and one that just suits in its shape a line of birds on the ground or water. Now, a single-barrel gun carrying the united charge of the double would not do nearly as much execution, so much of its circle of shot being wasted below and above the mark.

It must also be remembered that where the circles overlap, twice as many pellets are put into the fowl (where they are thickest) as can be the case in the centre of the circle fired by the single gun.

Another thing ; we have so arranged the locks of the double gun that they cannot, with even the quickest draw of the one trigger, be fired absolutely together. There is a small though appreciable difference. The effect of this is that the first barrel strikes the birds on the ground or water, and the

second cuts them down the moment they extend their wings and spring at the just previous flash and rattle of shot. The way Colonel Hawker managed the former feat was by having one barrel of his gun ignited by flint, the other by a detonator, and then pulling off both his barrels together, the two ignitions of course differing in rapidity. The way we have succeeded is by making one hammer, as it reaches the cap of its cartridge, free the other lock. With both hammers at full cock, we can fire with our one trigger one barrel by itself, or one after the other as quick as thought; or we can fire one barrel at a small number of birds, and if we find there are more fowl than we thought, or some were hidden, or others spring up near, or they offer a fair flying shot, then we can send the other charge after them as soon as wished. To succeed in this, however, a breeze is required to clear the smoke of the first discharge away.

Having now described the gun, we will speak of its performances, which were most carefully carried out by ourselves, before various friends and assistants.

The gun was aimed as if a rifle, straight at the object, neither under nor over.

Not having shot the gun before, we had to learn as we went on how it acted as to elevation. It was found that it shot high (a very good thing in all punt guns) by about a foot when aimed point blank. Had this been known at first it would have averaged another 100 to 150 pellets on the target for several of the single barrel shots. We used as a bull's-eye an exact outline, in size and shape, of a widgeon, cut out of cardboard; all shots being fired at 70 yards, measured.

Right Barrel.—20 ozs. No. 1 shot (82 to the oz.), 4 ozs. of powder (Colonel Hawker's). Average: 500 pellets in 6 ft. by 6 ft. target; 50 pellets in 20 in. diameter circle aimed at; 5 pellets in widgeon.

Left Barrel.—Same charge. Average: 532 in 6 ft. by 6 ft. target; 43 in 20 in. circle aimed at; 8 pellets in widgeon.

Right Barrel.—Same charge, only single B (75 to the oz.)

Average : 509 in 6 ft. by 6 ft. target ; 33 in 20 in. circle aimed at ; 5 in widgeon.

Left Barrel.—Same charge as last. Average : 515 in 6 ft. by 6 ft. target ; 52 in 20 in. circle aimed at ; 6 in widgeon.

This we consider fine shooting for the gun, and very regular. The lead of the shot pellets was splashed into fragments, or else flattened thinner than paper.

Double shot at target 18 ft. long and 6 ft. high, formed of nine 2 ft. plates, side by side, both barrels fired almost simultaneously. On the target were pasted eighteen card widgeon, 2 ft. apart, in two lines. The lower line one foot above the lower edge of the target, the upper line one foot above them. Charge, 4 ozs. of powder and 20 ozs. of No. 1 shot in each barrel ; distance, 70 yards.

In the centre of the plate, in a space of 6 ft. by 6 ft., at which we aimed, were 1,353 pellets. Every widgeon was struck, and the entire target covered with pellets. In the six centre birds were 11, 19, 12, 11, 9 and 8 pellets respectively.

We were much pleased with this shot, as it proved that one barrel when fired did not throw the other off its aim.

In all, over thirty rounds were fired without damage to gun or recoil apparatus. Double shots were also fired to test the recoil spring, without any rope breeching.

The recoil carriage ran back 18 in. with both barrels, and when one was fired, about 8 in.

The gun is very easy to aim with and quick and steady to turn. Had it not been for the cattle about, we should have tried some flying shots at single pigeons out of a trap at 70 yards.

It would be no hard task to bring them down, so perfectly is the gun balanced. The swivel of the gun drops into a block of elm. This block is dovetailed into and slides along a tramway of wood, several feet in length, very firmly bolted to the floor of the punt fore and aft, over the rafters—which latter are let into it. A strong rope is spliced through a hole in the stem piece under the fore deck, and secured round the

sliding block in which the gun is balanced. The block has a play of six inches fore and aft, with rubber buffers to take up the recoil should the gun overrun owing to the breeching rope stretching or shrinking. Irrespective of this, the gun is fitted with a recoil spring of its own. The fowling punt is 22 ft. 6 in. in length and 3 ft. 4 in. across the floor ; across the deck 4 ft. 2 in. She is constructed for lightness and great strength, and carries the gun and two men with comfort.¹

Muzzle-loading swivel-guns will, however, never go out of fashion, especially with professional fowlers, as they are light, cheap, simple, and safe, and cannot get out of order. Breech-loading swivel-guns are chiefly employed by amateur gunners, as they are less trouble to use, and their costliness is not of such great moment to a gentleman punter as it is to a poor man. Besides, the amateur, as a rule, knows much less of the uses and requirements of a big gun, and is more ready to purchase a novelty than is the professional gunner.

The following are good proportions for swivel-guns as to their weight and charges. Their suitability to various fowling punts in this respect has already been noted.

Total Weight	Bore	Charge of Shot	Length of Barrel
lbs.	inches	ozs.	ft. in. ft. in.
60-70	$1\frac{1}{8}$ - $1\frac{1}{4}$	10-12	7 0
80	$1\frac{1}{4}$ - $1\frac{3}{8}$	16	7 6 - 7 9
90-100	$1\frac{3}{8}$ - $1\frac{1}{2}$	18-20	7 9
120-130	$1\frac{1}{2}$ - $1\frac{5}{8}$	22-24	8 3
130-140	$1\frac{5}{8}$ - $1\frac{3}{4}$	24-26	8 6
150	$1\frac{3}{4}$	26-30	8 9
160-170	$1\frac{3}{4}$	30-32	9 0
170-185	$1\frac{7}{8}$ - 2	32-40	9 3 - 9 6

¹ Since this account was first written, for the readers of the *Field* newspaper, 1885, we have (during the winter 1885-86) fired eighty shots from this gun, and found it do its work admirably—the second barrel always just taking the birds on the rise—and we have been fortunate enough on the British coasts to knock over sixty widgeon at one double shot by its means, and several times twenty to thirty. We will add that the recoil arrangements worked admirably and without a hitch ; in fact, the recoil was imperceptible, the gun rarely moving two inches

From about 6 to 8 lbs. may be deducted for weight of stock and lock, and some 12 to 14 inches added for its length.

As nothing is known of the performances of swivel-guns of various sizes, in regard to their capabilities of pattern and penetration, we here give the result of some careful experiments in that line, carried out for us by our friend Captain George Gould, in whose company we have shot a great number of wildfowl, and who has a long experience and extensive knowledge of swivel-guns and of punting.

EXPERIMENTS WITH SWIVEL GUNS AS TO PATTERN AND PENETRATION, AND NOTES ON THEIR SHOOTING, BY CAPTAIN GEORGE GOULD (LATE ROYAL ENGINEERS).

Conditions of Trial.

Target. Of $\frac{1}{16}$ -inch sheet-iron, 12' 0" long by 8' 0" high.

Distance. 70 yards from muzzle.

Shot. Newcastle chilled marked BB and 80 pellets to 1 oz.

Charges of Shot. For $1\frac{1}{4}$ " and $1\frac{1}{2}$ " guns, 1 lb. For $1\frac{3}{8}$ " guns, 2 lbs.

Wads for B.L. Guns. Over powder, card, two felt and card, except where otherwise stated.

Wads for B.L. Guns. Over shot, card.

Wads for M.L. Guns. Oakum.

Penetration. The figures under this heading show the number of sheets of Pettitt's 'Field' pads broken by *three* pellets and through which daylight could be seen.

REMARKS.

$1\frac{1}{4}$ " Gun (*Gallwey Powder*). Before trying 2 $\frac{3}{4}$ ozs. of this powder, I had previously used a charge of 3 ozs., but found that with this quantity the pattern was not satisfactory.

one way or the other. We found in practice that by *pulling* the trigger, however quickly, the gun always discharged both barrels with a very slight interval, just sufficient, when firing at a number of fowl on the ground or water, to kill those birds, not struck by the first barrel, with the second barrel in the act of opening their wings to rise. On the other hand, by *jerking* the trigger we were able to get off both barrels quite simultaneously into a number of birds flying. On one occasion, with this gun, we dropped 24 widgeon, dead, at a measured distance of 120 yards out of 25 that fell to the shot, a flying one. The time required to load both barrels after a shot we found to be two minutes.

The five shots that I fired gave an average in 6' x 6' of 409.80 or 32.01 per cent. ; the penetration of three shots was 35 sheets ; pads not used for the other two shots. This powder appears to be much stronger than either Capt. Lantour's or Col. Hawker's.

1½" Gun (*Lantour's Powder*). Before trying 5½ ozs. of this powder, I had previously tried 6 ozs., but the result was not satisfactory. The three shots fired with 6-oz. gave an average in 6' x 6' of 703, or 27.46 per cent. The penetration averaged only 32 sheets.

TRIAL OF 1½-INCH B.L. GUN BY HOLLAND & HOLLAND.
WEIGHT OF GUN, 105 LBS. ; TWIST BARREL.

Powder : 3 ozs. Lantour's Grain. Day windy.

Pellets in 6' x 6' square	Pellets in 30" circle	Pellets in pad	Penetration
512	124	11	35
541	106	19	35
514	112	15	35
478	95	12	35
491	97	6	35
542	114	not used	
559	125	" "	
<i>Average</i>			
519.57	110.71	12.60	35.00

Percentage, 40.59.

Powder : 3 ozs. Col. Hawker's Grain. Day windy.

484	94	14	34
495	114	15	31
373	65	8	29
467	75	11	35
497	89	10	32
432	52	15	29
548	99	not used	
<i>Average</i>			
470.85	84.00	12.16	31.60

Percentage 36.78.

TRIAL OF 1¼-INCH GUN (*continued*)—

Powder: 2¾ ozs. Col. Hawker's Grain.

Pellets in 6' x 6' square	Pellets in 30" circle	Pellets in pad	Penetration
502	101	12	32
485	90	8	28
499	88	13	32
497	89	15	33
630	123	20	29
618	111	19	36
503	90	11	34
<i>Average</i>			
533.42	98.85	14	32

Percentage 41.67.

Powder: 2¾ ozs. Sir R. P. Gallwey's Grain. Day calm.

459	85	16	34
530	124	10	35
410	64	14	35
530	128	22	36
351	69	9	28
513	95	16	26
470	82	7	30
<i>Average</i>			
466.14	92.43	13.43	32

*Percentage 36.41.*TRIAL OF 1½-INCH M.L. GUN BY TRULOCK & HARRISS.¹

WEIGHT OF GUN, 75 LBS.; TWIST BARREL.

Powder: 3 ozs. Col. Hawker's Grain. Windy.

359	82	4	24
588	127	27	33
509	85	9	27
442	102		not used
672	148		" "
633	126		" "
576	112		" "
<i>Average</i>			
539.85	111.71	13.33	20

Percentage 42.17.

¹ We always considered this M.L. gun one of the best we ever used. We regret that we are unable to state its penetration.

REMARKS ON TRIAL OF M.L. GUN.

1st Shot.—3-inch hole made in target by oakum wad *over* shot, in which was embedded about $1\frac{1}{2}$ oz. shot. One pellet penetrated all 45 sheets.

4th Shot.—Shot balled and broke target slightly in two places. There were 10 small clusters in $6' \times 6'$, each being composed of probably 2 to 4 pellets, but could not be counted. A ball of paper was used *over* shot instead of oakum.

6th Shot.—The bulk of this charge was in right lower corner of $6' \times 6'$.

TRIAL OF $1\frac{1}{4}$ -INCH B.L. GUN BY HOLLAND & HOLLAND.
WEIGHT OF GUN, 175 LBS. ; STEEL BARREL.

First three shots $5\frac{1}{2}$ ozs. Capt. Lantour's Powder. Last four shots $5\frac{1}{2}$ ozs. Col. Hawker's Powder. Day calm.

Pellets in $6' \times 6'$ square	Pellets in 30" circle	Pellets in pad	Penetration
833	146	12	30
708	129	15	29
1009	194	28	45
983 ¹	187 ¹	29 ¹	45 ¹
1131 ¹	241 ¹	39 ¹	45 ¹
951	191	22	45
635 ¹	144 ¹	13 ¹	32 ¹
<i>Average</i>			
892·85	176·00	22·57	38·71

Percentage 34·87.

REMARKS.

5th Shot.—5 pellets through pad and marked plate.

6th Shot.—3 pellets through pad and marked plate.

7th Shot.—1 pellet through pad and marked plate.

It will be seen that the penetration of the $1\frac{1}{4}$ -inch gun was very good, and much in excess of the other guns experimented with. There is little doubt that, had the pad contained fifty-five sheets instead of forty-five, some of the pellets would have passed clean through it ; therefore, the average penetration as

¹ Three felt wads over powder instead of two.

stated above is somewhat below what it would otherwise be. Something peculiar must have occurred when I fired the last shot with this gun, as the result was so wild, but as I cannot account for it I have allowed it to stand.

ACCESSORIES OF PUNTING.

Punt.

Swivel-gun.

Swivel-gun crutch.

Elevating slide-rest for swivel-gun.

Cripple-stopper (i.e. a shoulder gun).

Three light oars—one a spare one.

Two paddles—one light for paddling to fowl, the other heavy to assist in propelling the punt after a shot up to the cripples, as well as for cruising—in a single punt, two small hand paddles and one large one for cruising.

Field-glasses or telescope. If looking for rare specimens, the former will not distinguish them, but for night work they are invaluable.

Rudder—if you fancy one.

Mast and sail (a small sprit-sail is best).

Breeching ropes.

Ammunition box.

Cork-stuffed life-buoy seat for rowing on.

Long stalking stick.

Short stalking stick.

Folding anchor, or grapnel, with a 30-ft. line.

Rowing spurs.

Foot-stretchers for rowing.

Cover for stock of swivel-gun.

Cartridge-case for small gun ammunition.

Sandwich-box, tobacco, lights, compass, and flask, in case to fit.

Loading rod, with screw head for cleaning the punt gun barrel, or drawing the charge (if a muzzle-loader).

Powder, shot, wads, oakum, and caps or tubes (in a breech-loader, cartridges).

Canvas, and wood case, for swivel gun (the latter for travelling).

Cover to close in cockpit of punt at night.

Gun-muzzle plug to keep out wet.

Powder spoon, or measure.

Punt waggon, and last, not least,—

A good sculler.

In a single punt the extra setting-pole can be dispensed with—that is to say, for a punt that is propelled up to birds by side-paddling. When a single punt is sculled to birds by an oar, the small hand-paddles are not required. To get up to the cripples after a shot in a single-handed punt the oars should be used, and you can kneel with your face to the stem and back water up to the wounded. They are then in plain view before you; pulling the usual way, you could not keep an eye on them from the first, as is most necessary after a shot from the big gun.

We will next give alphabetical notes on the various articles connected with punting, as being the simplest and shortest method of explaining the outfit required for fowling afloat.

Ammunition box.—This should be as waterproof and damp-resisting as possible. It ought almost to bear immersion without leaking, could it be so made. It can be lined with sheet copper (tin soon rusts), and should be made of $\frac{3}{4}$ -inch oak, with partitions to take neatly the description of ammunition which the gunner uses. It need be no higher than sufficient to hold a powder tin or cartridge case laid flat, and it will, though broad or long, be more portable and take up less space on board than if high and narrow.

Anchor.—This is quite a toy, but though small, will hold well. The anchor line should be spliced to a cleat on the after-deck, or else rove through a hole in the stern; then, when landing in a hurry to get cripples, the anchor can be thrown overboard without any delay in making it fast.

Bag for cartridges.—Another very damp-resisting and watertight article, required to carry the cartridges for the cripple-stopper. It should have a flap falling well over with *two* large buttons to it—not, as usual, with only one. The best way to carry it when tripping on shore after cripples is to have the bag made with two long hooks at its back, to hook over a belt round the waist. A bag round the shoulders will 'jump about' when you are running after cripples, and turn inside out when stooping to pick them up. Cartridges are easily

and quickly got at it carried in front, in a bag hooked to a belt.

Breeching for swivel-gun.—Though there are several other methods of easing the recoil of a big gun, it is admitted on all sides by practical gunners that no plan is so safe, simple, and strong as a plain rope breeching for an ordinary swivel-gun. The rope is laid over the fore-deck, round and through a hole in the stem of the punt, and its ends, which are formed into eyes or nooses, fit easily over the trunnions of the gun as shown in the plans, pp. 267, 272.

Balance of a swivel-gun.—This should be quite 8 in. behind the trunnions toward the stock, and some 2 ft. 6 in. from the breech end of the gun—never more than 3 ft., for the further the gun reaches into the cockpit the less space the gunner has to work in. The gun loaded should balance about 6 lbs. in excess towards the muzzle—that is to say, the stock would require a 6-lb. weight on it before it would lift the muzzle off the rest.

Cartridges for swivel-guns.—For breechloaders these are made of brass, steel, and paper. The paper ones are much the best; the metal ones, in our experience, always get damaged sooner or later by the explosion of the gun. They stick and crack, besides which they are difficult to clean unless this is done immediately after they are used. For use in muzzle-loaders shot cartridges are made on a mould of wood and sealed, the mould withdrawn, their ends turned down after the shot has been poured in, and twine strongly tied round them lengthways. A lump of oakum must be placed at one end under the string to act as a wad. For these guns we have also used very successfully powder charges wrapped in silver paper and kept in separate tin cases to fit them exactly.

Clothes.—Long thigh-boots, kept up by straps from their sides attached to the waist-belt. Plenty of flannel from skin to coat; nothing else will prevent rheumatism. *Grey* and not *white* flannel. Over all a white duck jacket for the sake of its colour, cut to slip on over the head, and without buttons, pockets, or opening down the front. In cold weather a fisher-

man's jersey is the safest and warmest thing to wear under the duck jacket.

Cases for swivel-guns.—You will want a stout wooden case. If your gun has trunnions, let them project through the sides of the case, which can then be small. For ordinary use make a canvas case to cover the gun from end to end, and jointed in the middle, where it can overlap and lace together.

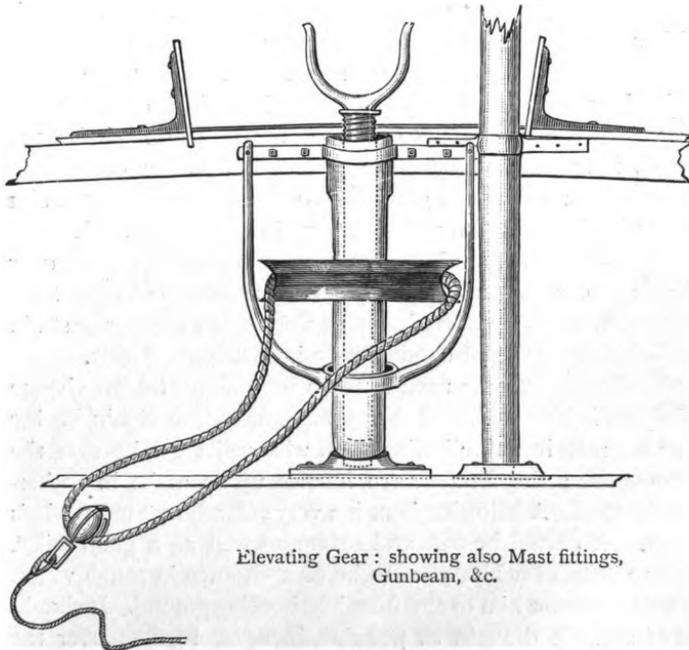

Elevating Gear : showing also Mast fittings,
Gunbeam, &c.

Cleaning-rod for cripple-stoppers.—These will require a great deal of cleaning at sea. Cut a stick a good deal smaller than the bore of the gun and six inches longer. Saw down one end a slit of a few inches; bore a hole at right angles to the slit near its end, and through the separate halves put a piece of 6-inch square thin flannel, and tie a piece of twine through the hole.

If the gun is very dirty, soak the flannel in turpentine, and polish with dry pieces afterwards. Keep the bits of flannel strung on a wire (see page 118, vol. i.)

Cushion of stuffed cork, for use when rowing; it may save your life some day, so never be without it.

Deck-rafters.—These support the fore and after decks of a fowling punt—six forward, four aft.

Dressing for boots.—Castor oil, neatsfoot oil, or vaseline.

Elevating gear for a swivel-gun.—This consists of a crutch with a thread on its shank, the shank working in a revolving hollow spindle, also fitted with a thread. On the spindle is fixed a wheel, and round the wheel is a short endless rope. By pulling the rope, and so turning the wheel and spindle, the crutch is screwed up, and the gun in it. It is a convenient contrivance for raising a gun so as to enable the shooter to aim over a bank or the sides of a creek at low water (p. 289).

Flooring boards are light thin planks made to fit down over the floor of a punt under the cockpit, to save the floor from getting damaged by heavy boots, as well as to prevent the strain of the gunner's weight coming upon it in one place only.

Following boats are used to tow a punt about till the chance of a shot is observed, and the gunner goes off to obtain it. He leaves a man in the following boat, who waits till he sees the gunner fire; the former then hurries up to assist in gathering the spoil. A following boat is a very safe adjunct to a fowler's outfit. It should be stiff and strong, as well as a good sailer, able to keep near him so as to be of assistance in rough water, as well as to tow him to and from his shooting ground. It should be of as light draught as possible, in order to float over the shallows.

Gun-beam is the large beam that ends the cockpit, and at which the fore-deck commences. The round of the gun-beam means its curve out of the straight line. It should be quite 3 in. wide and $1\frac{1}{2}$ in. thick, and in curve from 3 to 4 in.

Gun-crutch.—The spur or crutch in which the big gun is

balanced; its total length is about a foot, its shank some 8 to 10 in. It turns in a socket secured to the gun-beam.

Gun - hook. —

Hooks which are fixed to or under the coamings of a punt, inside the cockpit, and on which the cripple-stoppers are hung ready for use, with falling covers of waterproof material to keep off rain and salt-water spray.

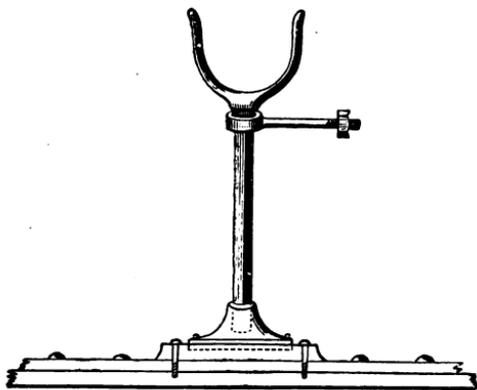

Plain Gun-crutch.

Gun-rest.—Similar to a billiard-cue rest, but flat on the top, with hollows to fit over the breeching ropes, and from 6 to 8 in. wide, so that the barrel of the big gun can be moved from side to side. Some rests are made to take the barrel in a groove, but then the rest and barrel have to be moved together should a shot to the right or left occur, and this is a bad plan. The handle of the rest is from 7 to 8 ft. long, and reaches level with the end of the gun-stock, when the gun is laid for shooting to 60 yards. The position of the rest handle is then a guide to the shooter as to how the gun is laid for a shot. By pulling in the rest the muzzle is of course raised; by pushing it out, lowered.

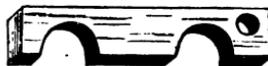

Head of Gun-rest.

Ignition.—This must be faultless in a big gun, as a miss-fire may lose you the worth of what a day's good shooting ashore might bring you. To make this perfect, no time or trouble, however much, is wasted. In muzzle-loaders no method is so good as what is called the 'double cap' plan of ignition. We quote from 'The Fowler in Ireland':—

The only absolutely certain plan of ignition for small or very large M. L. swivel-guns under all circumstances and conditions of weather :—

The brass safety-cover may be attached to end of trigger lanyard, to serve instead of loop or toggle.

Fill the large chamber in the plug with fine powder from a small flask, inserting also a little in nipples, and screw end home. A tiny key-wrench may be kept in case the latter sticks. The overcharge of priming escapes through dotted channel that opens downwards in screw end. When the gun is likely to be kept primed a long time this orifice may be stopped with wax, else it is

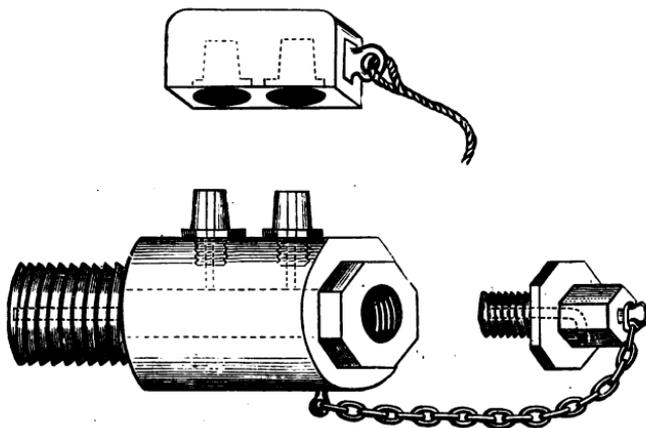

Double-cap side Plug for Muzzle-loading Swivel-guns.

never necessary to do so. The nipples in such case may be protected with caps flashed previously in the fire; and the gun would go off as well in a year's time as the day it was loaded. The holes in safety-cover should be drilled so deep that the caps are not in contact with the cover when it is over them. The length of main screw depends upon substance of side of barrel at breech. This screw should not go right through to the inside, but leave $\frac{3}{8}$ in. to $\frac{1}{2}$ in. of metal between its end and chamber of gun. Diameter of hole in plug, $\frac{5}{16}$ in.; in screw end, $\frac{1}{8}$ in.; through side of barrel and in main screw, $\frac{1}{16}$ in. Outside diameter of plug, 1 in. Length of plug without ends, $1\frac{1}{8}$ in.; small screw end, $\frac{3}{8}$ in. long. Ends of

small channels, and corresponding one through side of gun, to be bushed with platina to prevent their wearing too open.

We have fired over a thousand shots by its means without a miss-fire or a suspicion of one. Mr. Patstone, of 25 High Street, Southampton, has made us several, and the arrangement can be fixed to any muzzle-loading swivel-gun. For a small gun the tube ignition is excellent. Even breechloaders miss fire now and then; but this accident is usually caused by the absence of $\frac{1}{2}$ oz. of fine powder over the base of the cartridge before putting in the coarse grain.

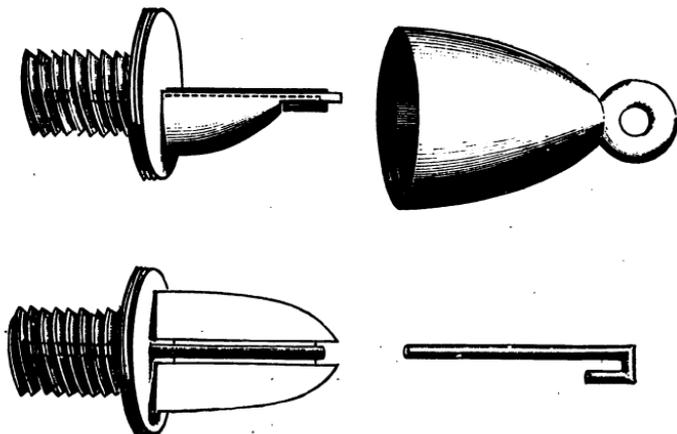

Tube Ignition, with Safety-cover.

(*Tube shown separate as well as on anvil ready for firing.*)

Judging distance.—A particularly hard thing to do when lying prone in a punt in the act of drawing up to fowl. One hundred yards distance on water looks a mere nothing, scarcely what fifty would appear on land. Constant practice will alone teach a young fowler how to tell the length of the open space between him and the birds he is setting to. A drawback that hinders him from forming a correct estimate of this distance is the anxiety to fire at the birds before they fly

away, and so to make a long shot a longer one than it need be, and a fair shot (as it might have been with a little patience) into a long one.

Loading swivel-guns.—If a muzzle-loader, after firing, rub out twice with oakum wrapped round the screw head attached to the end of loading rod. Pour a charge of powder into the loading spoon. Insert this to within two feet of the breech of the gun, withdraw it a little, and with a jerk send it all home. With a little practice you can soon do this easily, quickly, and without spilling a grain. Next ram home the oakum wad, put in a shot cartridge, and ram this down also. You will see—or, if at night, *feel*—by means of a brass nail driven into the loading rod at the correct point, if all is done right and the charge sent home. The ignition can be seen to when you expect a shot. To make a breechloader shoot very hard and close, put half the shot into the cartridge case, then pour in thin tallow, fill in with the rest of the shot, and pour in more tallow till all is level.

Mud-boards—are used to walk on treacherous, rotten ooze, and consist of 12 in. square, $\frac{3}{4}$ -inch thick elm boards strapped to the feet something like a skate. There should be a fixed strap to put the toe under, another to tighten round the instep, and a small block of wood to put against the heel, hollowed to fit it.

Oil.—(See p. 115, vol. i.)

Paddles.—The small pair of hand-paddles that are used by the fowler in his side-paddled single punt, one in each hand, are—

	ft.	in.
Total length . . .	2	3
Length of blade . . .	1	8
Width of blade . . .	0	$3\frac{3}{8}$ and $\frac{3}{8}$ in. to $\frac{1}{2}$ in. thick at their ends, so as to stand pushing with.

Smaller paddles, for deep water only, may be 1 ft. 10 in. long and $4\frac{1}{2}$ in. wide; double-bladed cruising paddle (p. 295).

	ft.	in.
Total length	11	0
Length of each blade	1	6 and $\frac{1}{2}$ in. thick
Width of blades	0	5

For a double punt the paddle used in working up to fowl may be 4 ft. 8 in. long; blade, 2 ft. 3 in. long, 6 in. wide; of thin oak with a willow handle. Another for cruising about with or for chasing cripples may be 6 ft. 3 in. long; blade, 2 ft. 4 in. long and 5 in. wide (see plan of double punt, p. 272).

Powder.—There are two well-known descriptions, namely, Colonel Hawker's and Captain Lantour's. We prefer the latter, as cleaner and stronger. We would, however, recommend wildfowl shooters to try some powder and chargers which we have lately brought out, and which are sold by Mr. Patstone, gunmaker, 25 High Street, Southampton. These chargers are round tin boxes, each just holding a charge of powder. A fowler can order any charge he likes to suit his gun, from 2 ozs. up to as much as 6 ozs. When loading a muzzle or breech loading swivel-gun the cover and lid are taken off the chargers, and the powder poured direct into the gun, cartridge, or powder spoon. Therefore all measuring is avoided, more powder than is necessary need not be carried about, and the powder cannot get damp through the tin being half used and then put on one side, as is often the case with large powder tins.

Ramrod.—In the best of guns cartridges will now and then stick, when they get wet. To see a number of cripples scattering over a mile of ooze, with a jammed case in the cripple-stopper, making the latter perfectly useless, is maddening, though it may occur

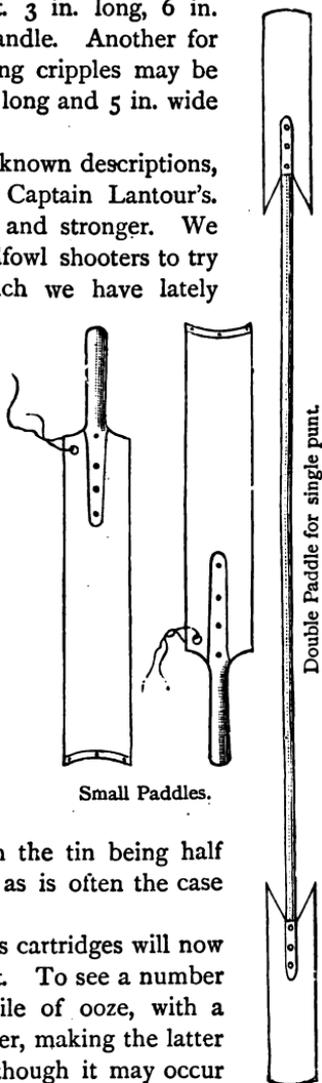

Small Paddles.

Double Paddle for single punt.

only once in a season. To obviate such a sad mishap, carry a four-jointed, folding ramrod—the joints being connected by hinges. It can be

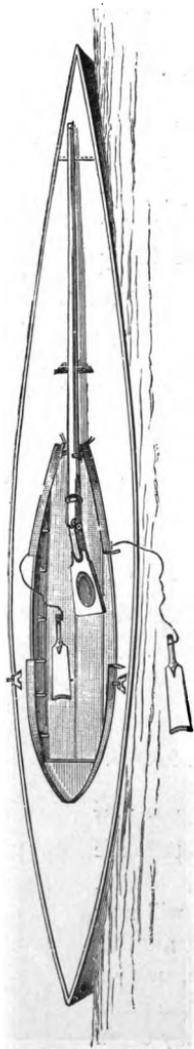

Fowling-punt and Gun fitted with Bootjack Recoil.

When setting to fowl the shooter leans his chest on the cushioned board as he paddles over each side of his craft through the openings in the coaming that at other times are closed by their movable shutters. The gun must be well overbalanced outwards, so that it will not tip the muzzle too easily. By pressing against the board as the shooter rests on it, the gun can be instantly elevated for a flying shot. This punt may be built lighter than any other method of recoil requires, as the stem, stern, and floor require little weight or strength. The trigger should be large, and covered with cork or soft leather, as, having no lanyard to it, the fowler needs strike it with his fingers to fire the gun. A gun carrying twelve ounces of shot may be thus used with ease and safety, and without any unpleasant jar to the shooter. The punt may be, for a sixty to seventy pound gun, and ten to twelve stone man:—

Length on deck	ft. in.	Width at gunwale	ft. in.
Length on floor 17 0	Width of floor 3 0
 16 5	extreme 2 0
Height of stem, 4½ in. ; of stern, 7½ in.		Material, ½ in. to ¾ in. yellow pine.	Decks, ¾ in. to 1 in.

put in a pocket beforehand, and if its aid be required in knocking out a tight case it is invaluable and instantly successful.

Recoil.—This has been alluded to under *Breeching*, which is the most effective method of meeting the recoil of a big gun. There are several other systems, but only one that has been tried and found to answer, and that is Colonel Hawker's. This is an admirable and perfect invention, but adapted more for the large and heavy punts of days gone by than for those now built. The fowl are nowadays so shy that the light

thin-planked punts in which we get at them are not strong enough to bear the heavy block necessary for the shank of the spiral spring arrangement. If one plan is found to answer perfectly under all phases of punting, and with all kinds of big guns, there is therefore no occasion to seek for another ; but as 'bootjack recoil guns' have long been in use, and the best method of applying the system is not generally known, we have given a cut of a punt and gun so fitted, with dimensions.

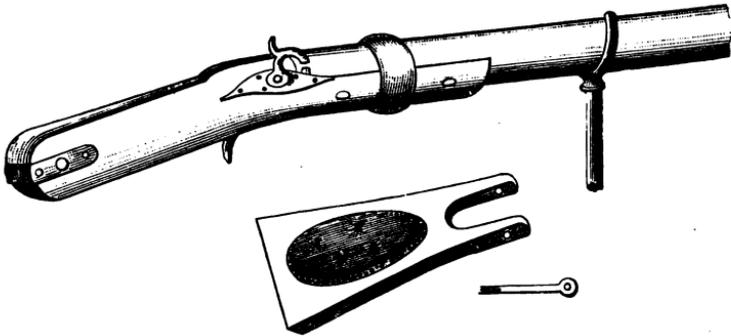

Swivel-gun with Bootjack Recoil-Board.

Elm board 16 in. to 18 in. long, according to bend of stock and depth of punt ; the longer the board the less will recoil be felt ; 10 in. to 11 in. wide at base, 6½ in. outside at neck ; the former 1½ in. thick, the latter 2½ in. ; hollow to take gunstock 5 in. long, and each arm strengthened outside by copper plate. The face of board to be hollowed out ¼ in. deep, packed with wool rising ½ in. above surface, and covered with leather or canvas. Lower edge of board to be sloped to run smoothly on floor when attached to gunstock. Connecting pin ½ in. iron, with a small nut to keep it from slipping back.

Rowing spurs.—These are plain metal crutches, with a shank of from 9 to 10 in. long and ¾-inch in diameter. Across the fork in which the oar balances they may be 3 in. They should slip into holes bored through the side-decks, and so down into blocks of wood underneath. They are then removable at pleasure, and leave the decks clear of all obstructions when going alongside a vessel or quay. Fixed rowlocks are always objectionable.

Rudders.—A rudder is never used in a single punt, as a man would require a third hand to work it. In a double punt rudders

are sometimes seen, but are more ornamental than useful. A good puntsman can guide a punt to an inch with oar, pole or paddle if fowl can be got at at all.

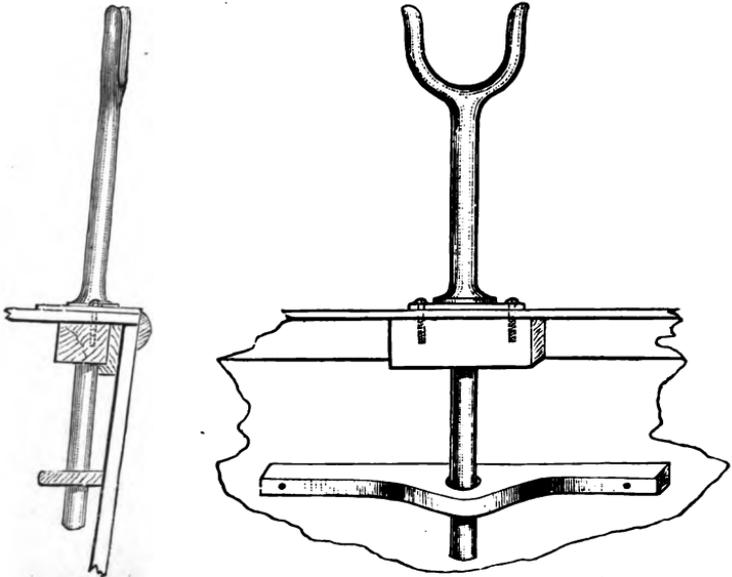

Rowing Spurs, and how to fit them.

Sail.—For a double punt a sprit sail is best, as if it comes on to blow the sprit can be taken out, and a small sail made of a large one instantly. The dimensions may be :—

	ft.	in.
Leech	10	0
Hoist or luff	7	5
Head	4	6
Foot	7	6

Material—strong linen, barked.

Mast—9 ft. 3 in. high.

For a single punt a much smaller sail can be used. A 'leg of mutton' sail, with a boom hinged to the mast, makes a good sail for any fowling punt.

For a double punt such a sail may be—mast, 9 to 10 ft. high. The boom hinged on 1 ft. 6 in. from foot of the mast. The sail edge along boom to be one foot shorter than it

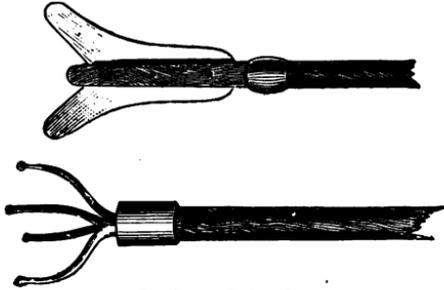

Setting pole heads.

is along mast—that is to say, the boom will be 2 ft. 6 in. less in length than the mast.

For a single punt the mast may be 8 ft. high; the rest in the proportion just given.

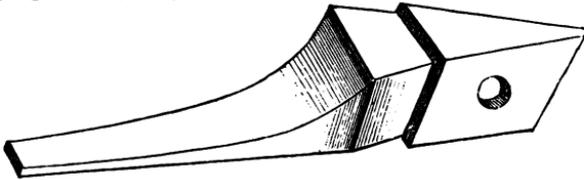

Stem of a Fowling Punt.

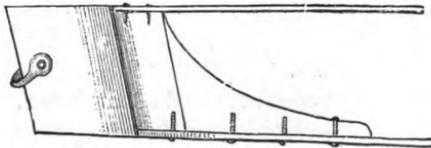

Stern of a Fowling Punt, fitted.

Setting pole.—6 to 8 ft. long according to the depth of water and whether it be required for a small or large punt. This pole is in general use aboard fowling punts, both for pushing a punt along when cruising in search of sport, and

at times for working it actually up in shot of wildfowl, for which purpose it is occasionally very useful.

The pole should be so weighted with lead as to float upright in water, it will then adapt itself to all contingencies.

Set of a swivel-gun.—That is, the height of the muzzle of the gun above the water. It is as great an error to have it too low as to place it too high. If too low, most of the shot will be buried in the water when fired at fowl swimming, and the portion of the charge that strikes the surface will ricochet high up into the air, even over the head of a swan. The correct height is about 10 in., when crew and gear are aboard. If the gun, as it balances in its crutch, is just clear by a quarter of an inch of the deck of the punt at the gun-beam, it is sure to shoot well—that is, if the measurements we have given for adoption in constructing fowling punts are adhered to.

Stem and stern of a punt.—The latter tapers some 22 in., and the former a foot, along the centre plank of the floor, to which they are very securely fastened.

Shot.—For swivel-gun shooting—For teal or plover, No. 2. This is also the best size for night shooting.

Wildfowl shooting in early winter, before the birds have their full plumage, No. 1. This size is about equivalent to B.

Wildfowl shooting throughout the winter, after November 15, A. This size is the same as BB. If fowl are very wild, AA may be used, or BBB.

For swans, brent, and other geese, SSSG.

For cripple stopping, No. 5. Flight and shore shooting with 12-bore gun, No. 4.

Heavy shoulder gun, ashore and afloat, No. 2.

For a double punt single-barrelled cripple-stoppers are light and handy: they should carry $1\frac{1}{4}$ oz. of No. 4 or No. 5 pleasantly. Two will be required—one for the gunner when after the wounded ashore, and a second for the puntsman should a double punt be in use (if a single, the crew of the following boat, if in attendance, can carry a second gun), to go after any birds that make for or fall into the water after the shot

from the big gun. In a single punt a double gun is requisite, if the fowler has no one to assist him in recovering the spoil after his shot, as he may want to fire hard and fast.

Shutters.—These are the portions of the coaming of a punt that are cut out and hinge down flat on the side decks, or else lift out. They then leave a space for the paddler to put his arms through to work his paddles on either side in a single punt. In a double they enable the puntsman to scull his oar, or use his setting-pole as well as his double-handed (not double-bladed) paddle, when setting to fowl. In a single-handed paddling punt the openings are just opposite where the shooter's arms would work when paddling to fowl. In a

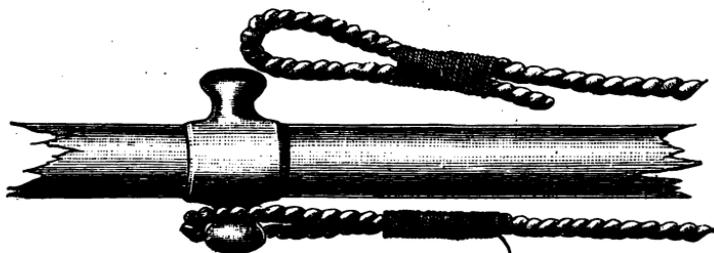

Trunnions for a Swivel-gun.

single-handed oar-sculled punt, as well as in a double punt, there is usually one opening only, on the starboard quarter.

When rowing about the shutters and wash-boards on the after-deck are hinged up, and fastened by small hooks and eyes, to keep the sea and spray out; it is only when the gunner is setting to fowl that they are lowered, to give him space to use his means of propulsion when lying down. The forward wash-boards shown under the gun (see plans) are put up to fend off a head sea as required. All wash-boards are hinged to the deck and secured upright by hook and eye.

Spur strap for duck-boots.—A strap round the heel and instep that prevents the boots from 'sucking' off in soft ground. If the boots be made tight to avoid this, you will sometimes have to dine in them, if not sleep in them as well.

They must, therefore, be made large and easy, with a strap to tighten them round the ankle.

Timing a shot with a big gun.—If within easy range of fowl, put them up by whistling or rapping your toe against the floor of the punt, and fire just as they 'lift.' If within fair range—say, 65 to 70 yards—fire the instant the fowl raise their heads; they will then be up just as the shot reaches them, and you will even notice that some of them are cut down while flying through the air. If a long shot is fired, pull the trigger without causing the birds to rise or waiting until they lift their heads. They will see the flash of the gun and spring just as the charge reaches them.

Anyone can bang off a swivel-gun, and perhaps bring down a few fowl, but it requires very considerable practice, a quick hand and eye, with great judgment of distance, of wind, and of the movement of your punt, before as many birds are brought to bag as should be secured if the shot is a successful one. To make good shots with a swivel-gun, and to do so often, is no easy matter, however tame and numerous the birds may be. When they are wild and scarce nearly every shot fired is a difficult and often an uncertain one, even with the most experienced of fowlers.

Towing-rope.—This is quite independent of the anchor line, or it should be so, as then each can be relied on for its own work. The towing-rope is made fast to a hole half-way down the stern of the punt, so as to lift her well up over rough water.

Trunnions for a swivel-gun.—These are round iron knobs attached to an iron collar. The collar is shrunk on the barrel of the gun about 8 in. behind the balance of it, so that it is at all times well clear of the crutch when the recoil takes place. The trunnions project some $2\frac{1}{2}$ to 3 in. on each side of the gun-barrel, and have a neck of about $1\frac{1}{2}$ in. in diameter, so that the eyes of the breeching ropes are retained in position (see p. 301, and plans of punts).

R. P. G.



Hurrah ! Real duck-shooting weather at last

CHAPTER XVI.

CONCLUDING REMARKS ON WILDFOWL SHOOTING.

THE estuaries on the coast of the British Islands where punting is chiefly carried on are as follows :—

In Scotland, Dornoch Firth, Cromarty Frith, and Beaully Firth are about the best, and in hard winters fowl are killed by

punters on the Tay and Firth of Forth, but the latter are never such good places as the former. In Scotland punting is not nearly so systematically undertaken by amateurs as it is in England and Ireland, yet a few gunners of our acquaintance do extremely well with their big guns on both the east and west coasts of Scotland.

In England punting is in vogue on all parts of the coast, from Berwick round to Carlisle. In the Humber punting is always going on. On the shores of the Wash punt gunners abound, and, what is more, venture afloat in the narrowest and most unsteady of all the crafts used in the pursuit of fowl, whether at home or abroad. The Lynn punts are, however, very fast, and in safe waters most successful. They are from 17 to 18 ft. long, and only 20 to 23 in. broad across the floor; across the deck they are from about 2 ft. 6 in. to 2 ft. 8 in. The Lynn gunners declare that no other punts can compare with these narrow and dangerous floating planks of theirs. But that is always the way—our own things are always superior to those of others. Anyhow, they kill fowl in them well enough when they get the chance, which is the main point. Yarmouth is the next abode of big gunners, who are there always on the watch for birds at sea as well as for rare specimens on the adjacent Norfolk Broads.

Then we have Lowestoft and Harwich, and so on to the Essex coast, and that very home of punters, the Blackwater estuary.

There is but little shooting at the mouth of the Thames or on the north coast of Kent, nor is there any gunning to speak of till Southampton Water is reached. But the Solent is full of punters, especially about Lymington and other parts of the Hampshire coast that lie opposite the Isle of Wight.

There are no finer feeding grounds in our islands than the flats that fringe for miles the north bank of the Solent, but gunners are numerous, and the fowl have but few chances of feeding and resting in peace. Yet in severe winters, when ice and snow prevail and east winds are in force, the Solent is

full of fowl, though they soon become so wary from constant persecution by sailing-boats, steamboats, and every other kind of craft, that the fowlers have not a fair chance of making good bags. It is not as if the use of sailing-boats and steamers brought sport to their owners, for they never did and never will. They are merely 'bird frighteners' of the most un-sportsmanlike and selfish kind, and their owners may be seen reclining at ease in the bow or stern, firing bullets at the geese or ducks, shooting shot at impossible ranges, and bringing aboard nothing in the shape of feather. Meanwhile the poor fowlers, whose living in the winter depends upon their being able to shoot a few fowl now and then, are woe-fully disappointed; for the birds, getting no rest from these idle, useless, sport-spoiling persons, leave the locality soon after their arrival for less persecuted spots. If a fowler be a rich amateur and desire to shoot fowl, he should set about it in a proper way. If he only wants to frighten the birds for the sake of obtaining two or three a day, he had better remain at home, and keep away his puffing, sport-destroying steam launch, which all honest fowlers would wish to occupy a berth at the bottom of the sea.

Poole Harbour is the next gunning station west of the Solent (as Christchurch Bay is given over to shore shooters). This fine estuary is from six to seven miles square, and was formerly one of the best grounds for wildfowl in the kingdom. Now it is overrun with professional punt gunners; a glance at the rows of punts to be seen there on the beach about Christmas easily accounts for the wildness and scarcity of the birds, and the lack of sport now compared to what it was in days gone by.

After Poole, and continuing our tour round the coast towards the west, we reach Weymouth, which is not a good punting neighbourhood, as the fowl take shelter in the famous decoy close at hand.

The Exe is also unfavourable for gunning, the birds being very wild and scarce.

Falmouth Harbour is too noisy, from the amount of shipping, to hold fowl, and all round the coast of Cornwall and the north of Devon and Somerset the shores are rocky and unsheltered, and there are no good feeding grounds to attract and keep birds.

In the Bristol Channel we have seen large numbers of widgeon, but this may be called the open sea, and it is useless for wildfowl shooting.

In Milford Haven we have also seen good numbers of widgeon, and there are a couple of fowlers there who now and then do well.

We have tried Holyhead for gunning, and though we have seen fine shots thereabouts, for a swivel-gun, they were invariably in open and dangerous waters. There are two or three punters who shoot round Holyhead Island and off the west coast of Anglesea.

The estuary of the Dee, though apparently a first-rate ground for punting, abounds in sandbanks and lacks the green weed necessary to attract wildfowl. It is natural that where food is not to be had birds are not to be found. Punters, therefore, are not partial to the Dee—at least, we know of only a couple who shoot there.

The Mersey is still less adapted for fowling, being wide, unsheltered, and crowded with shipping. We have seen a few fowl round the coast from the mouth of the Mersey to Whitehaven, in Cumberland, but only in hard winters are they ever fairly numerous. Twenty-five years ago a friend of ours killed forty widgeon at a shot at the mouth of the Ribble; ten would be considered good now. This coast, however, could never have boasted one-tenth of the fowl that were to be seen on the eastern shore of England. It is not suited to them, as it is chiefly hard sand; there is but poor feeding for the birds, and it is the wrong side of England for migratory fowl to drop on.

The chief punting stations in Ireland are Belfast Lough, Strangford Lough, Dublin Bay, Wexford Harbour, Cork

Harbour, Dingle and Tralee Bays, the Shannon (on which there are about a dozen double-handed punters), Galway Bay, Killala and Sligo Bays, as well as Lough Swilly and Lough Foyle.

We have shot (with one or two exceptions) on all the waters we have named, and had grand sport on some of them; but, alas! fowl are getting scarcer and gunners more numerous every year, and we fear that a bag of over 1,500 duck and geese, besides plover, &c., in a season will not be our lot again in the British Islands, as it was in the hard winter of 1880-81.

A heavy shot at fowl is becoming a rare chance now on our shores, and is only achieved in very severe weather. Some ten years ago, off the mouth of the Blackwater, in Essex, a wonderful shot was made at brent geese. A vast herd of these birds had collected on the ooze to feed. All the local punt gunners; to the number of a dozen, were attracted by the sight, and setting together to the geese just as they were densely packed on the last bit of feeding ground left by the rising tide, aimed and fired by signal. The result was that the gunners picked up close on 300 fowl. This incident was recorded in various sporting papers at the time, and was related to us by a gentleman who had actually seen the occurrence.

Within the past ten years we have known of several shots that realised from forty to fifty widgeon on the east coast of Scotland, but such luck has not been had on any part of the English coast as far as we can learn for many years. A gunner of our acquaintance in 1881 killed thirty-seven widgeon at a shot in the Solent by night, and two or three times from fifteen to twenty brent at a shot by day the same year.

In Ireland we have many times killed fifty to sixty widgeon at a shot, and now and then from sixty to seventy. Our friend Mr. Vincent has on several occasions bagged eighty widgeon at a shot—once ninety-six—and, again, 105 teal (the latter a flying shot) off the coast of Ireland. We have known of forty-seven grey geese to be bagged at one shot in Ireland, and several times between thirty-five and forty-five brent. Colonel

Hawker speaks of having once obtained nearly a hundred brent at a shot from his double swivel-gun in the Solent, after one discharge of both barrels at the same time, and we have several times quite lately, both at home and abroad, set up in our punt to packs of widgeon and brent geese of which, could we have got in fair range of them, we should have bagged fully a hundred at a single shot.

Daniel, in his 'Rural Sports' (written at the beginning of this century), mentions that he knew a punter of the name of Bowles, who cleared 100*l.* in a season's shooting. The birds were sold to the dealers at 2*s.* a couple, one with another, which, allowing 30*l.* for current expenses, would represent 2,600 wildfowl brought to bag in some five months' shooting.

The heaviest shot which we can personally vouch for at widgeon brought down 127, which was the number picked up with a gun firing only twenty ounces of shot.

A few words in conclusion about the books that treat of fowling, and of swivel-guns and cripple-stoppers.

Foremost and unrivalled stands the work of that father of wildfowl shooting, Colonel Peter Hawker. The great popularity of this book is shown by the fact of its having run through eleven editions, some of them unusually large. It is a book that for terseness, accuracy, and original information is without an equal. The information it contains may not seem original in these days, because its contents have been freely copied into almost every work on guns and shooting published since its first edition appeared at the beginning of the century. This has been done simply because Colonel Hawker's work for many years stood alone in its complete instructions in everything relating to the use of the gun, either afield or afloat. With a few slight alterations, such as the substitution of breech-loaders for muzzle-loaders, it is in many respects as useful for reference to this generation as it was to the last, and especially so with regard to the habits and shooting of wildfowl.

The illustrations to the later editions are excellent as sporting pictures of wildfowl shooting. We know of no book on

shooting that can compare with Colonel Hawker's in this respect. It is even at the present day our standard book on wildfowl shooting, and by far the best written one in the English language. There is scarcely a country house in the British Islands that does not possess a copy of it, or a sportsman who has not more than once read it from cover to cover.

The best edition is the ninth, published in 1844; the tenth, brought out ten years later, and the eleventh, in 1859, were edited by Colonel Hawker's son, and are much abridged. They are therefore not nearly so interesting as the edition of 1844.

Being such a popular book, a clean copy fetches a good price, and there is always a steady demand for the work. A London bookseller informed us that he sold forty copies during the last hard winter, as of course during severe seasons fowlers multiply, and wildfowl shooting books are naturally in demand. Publishers, Longmans. Price about 12s.

Folkard's 'Wildfowler.'—This is another work which charms the hearts of all wildfowl shooters. It is not, however, nearly so practical as the one last mentioned. The author treats exclusively of the east coast of England, and completely ignores double-handed punting, which, in the opinion of most amateur punters, is the cream of wildfowl shooting. Mr. Folkard evidently had no experience whatever of this mode of shooting, and, like many another punter, considered in consequence that the methods which he put into practice himself, and saw others employing, were the only ones by which to succeed with the wildfowl. Hence he dismisses as unworthy of comment a method of fowling that annually brings to bag many thousands of duck and geese in various parts of the British Islands, notably in Ireland and Scotland.

But though Mr. Folkard is very scant of information in the matter of shooting with punt and swivel-gun, his knowledge of other phases of fowling is extensive and accurate to a degree. He touches on many subjects, such as 'decoys' and 'flight

ponds,' which until he did so were hardly even alluded to in any sporting work then extant, or if they were, in the most grossly inaccurate manner.

This book is beautifully illustrated, and treats of fowling in every known country; and the compilation of this, the larger part by far of the work, shows a wonderful amount of research. The natural history of the different species to be met with by the fowler are, with one or two exceptions, both lucid and correct, and it is to be regretted that they were not illustrated by engravings; for, even in these days, ducks are ducks, geese are geese, and swans swans, to nine shooters out of ten, and what a multitude of species is embraced by the three names is but little realised.

The last and best edition of 'The Wildfowler' (the third) was published by Messrs. Longmans in 1875, and may be bought for about 15s.

'The Modern Shooter.' By Captain Lacy.—A work evidently written to imitate Colonel Hawker's, yet by no means a bad book all the same. It is overloaded with Latin, Greek, and English quotations, both of poetry and prose. Were these cut out this volume would not only be improved but also reduced to half its bulk.

It lacks the most interesting part of all sporting works, viz. appropriate illustrations. The engravings are few, and poor in subject and execution with one exception, that being a picture by Prior of the author's three favourite pointers. This plate, the frontispiece, is justly considered one of the finest and best pictures of its kind ever put into a book.

The instructions in land game shooting almost rival those of Colonel Hawker, but the wildfowl shooting directions are meagre and badly explained. There is nothing practical or to the point about them. The author seems to have been conscious that he knew but little about the subject. Colonel Hawker, in his ninth edition, thus writes of Captain Lacy:—

Since our eighth edition there has at last appeared, after a lapse of nearly half a century, another original and admirably well-

written work, by Captain R. Lacy, who, as a novice in wildfowl gunning, and an utter stranger, applied to me in a letter of *seventeen* pages for the 'very great favour' of some private instructions, which I gave him to the best of my ability. He afterwards hired Buckle, who 'spun out his yarn' while the captain took down his depositions.

These are rather back-handed compliments from the Colonel. Buckle was Colonel Hawker's puntsman previous to 1824, and, having quarrelled with his patron, endeavoured to annoy him by assisting Captain Lacy to compile rival instructions to his late master's in wildfowl shooting. Buckle was a first-rate gunner and sportsman. He shot a good deal in Ireland, and we lately saw some old shooting things of his in the county of Kerry. Buckle lived to over eighty, and we paid him a visit (alas! in the workhouse) just before he died, only five or six years ago.

'The Modern Shooter' was published by Whittaker and Co., London, in 1852, but it did not reach a second edition. It may be picked up now for six or eight shillings, and is well worth as much.

'The Dead Shot.' By 'Marksman.'—One of the best modern works on guns and shooting in a small compass that we have. But the few illustrations it contains are very badly done, and literally eyesores in their grotesque inaccuracy.

The information it supplies on shoulder guns—how to use them, choose them, and take care of them—is some of the best we ever read, and the very practical directions on shooting are admirable. There are also accurate descriptions of the habits of game and wildfowl, and how to obtain them.

The part of the book that treats of punt gunning surpasses Folkard's account of this sport, but it has the same fault, in omitting all mention of the common practice of double-handed shooting, save to allude to it as a useless and obsolete mode of obtaining fowl. This shows that the author's experience was local, and probably confined to the east coast of England; yet the general instructions in this branch of fowling—i.e.

single-handed punting—could not be better or more explicit, considering the absence of all plans and dimensions, without which no work on fowling could really be of use to a novice. The fifth and last edition, published in 1882 by Messrs. Longmans, is the best.

'Modern Wildfowling.' Published in 1880, under the auspices of the editor of the 'Field' newspaper.—This is a collection of letters that appeared in the columns of the 'Field' in 1878-79, contributed by various correspondents, and exclusively devoted to shooting with punt and swivel-gun. The book was supervised by Mr. L. Clements, well known as a wildfowl shooter and editor of 'The Shooting Times,' a capital little paper.

As may be imagined, all these letters express different, and often totally opposite, views of the same subject, and readers of the 'Field' were much amused by the continual disagreements and diverse opinions on the question of the proper kind of punt and gun to use in wildfowl shooting. To a beginner in the art of fowling the many opinions given were naturally, from their contention, somewhat perplexing; but to a fairly experienced fowler they may still be read in their book form with interest and amusement.

'The Gun and its Development; with Notes on Shooting.' By Mr. W. W. Greener.—This is the most comprehensive modern work we have in our language dealing with guns. Not only does it treat fully of the very earliest arms known, commencing with bows and arrows, but is equally accurate and exhaustive in regard to all recent inventions in gunmaking. Every kind of sport to be had with the gun is here also described and commented on in a practical and interesting, though very condensed, manner, and the gunning to be done, or expected, in every corner of the globe is well described in Mr. Greener's admirably written book. Every gun worth mentioning, with its mechanism, is fully and carefully engraved, and explained for those who care for the technicalities of gunmaking.

We would strongly recommend this capital treatise to all who own a gun, not only as a most useful adjunct to their sport, but as the best of tutors in the matter of all that has to do with firearms of every description, large or small, from swivel-guns to cripple-stoppers and 20-bores, and from elephant to rook rifles.

Amongst the mass of useful information on shooting contained in this large work of over 700 pages, wildfowl shooting is very fairly, though briefly, described and illustrated. We consider Mr. Greener's work a wonderful example of care, patience, and ingenuity; that this is also the opinion of the general public is evinced by the fact of its third edition being so soon called for. The first is dated 1881, and the last, considerably enlarged and improved, 1885. The publishers are Cassell and Co., London, and the price is 10s.

'The Modern Sportsman's Gun and Rifle.' By Mr. T. H. Walsh. Published at the 'Field' office, 1882.—It might now be written as '*Lately* the Modern Sportsman's Gun,' &c., so speedy is the march of change and improvement in guns, that what was modern a few years ago is at the present date almost old-fashioned. This book was intended for the use of the gun-maker, and not for the practical sportsman. To the former, it is a first-rate trade catalogue; to the latter, it is so completely given up to the interior mechanism of guns that it is of very slight interest. It is, in fact, nothing more or less than a *réchauffée* of the only part (fortunately that a small one) of Mr. Greener's book that is of the least general interest to a shooter. This work consists of two volumes, one devoted to the mechanical parts of the gun, the other to those of the rifle.

Besides the books we have mentioned there are many others that allude to wildfowl shooting in a desultory fashion, their account of the sport being rarely original, but usually second-hand, and chiefly taken wholesale from the pages of Colonel Hawker. For instance, Blaine's 'Rural Sports,' otherwise an admirable work, now out of print. The few remaining copies of this book—a very cyclopædia of sporting—were lately

bought up by Mr. Sampson, the well-known bookseller of York. Third edition, 1875.

'The Sportsman's Cyclopaedia.' By T. B. Johnson. 1831.—This author quotes pages on wildfowl shooting from Colonel Hawker, and abuses him royally at the same time, being palpably jealous of the success of his contemporary.

'Sport in many Lands.' By H. A. Leveson.—Contains the career of a stirring and adventurous shooter all the world over. There is a chapter on punt gunning, with an illustration deliberately copied from Colonel Hawker's book, and entitled 'Cripple Stopping.' Publishers, Frederick Warne and Co.

Daniel's 'Rural Sports.'—Contains one of the earliest, if not actually the earliest, authentic accounts of wildfowl shooting with punt and gun, besides many incidents connected with fowling that are of great interest as records of the sport of catching and shooting duck in days long past.

Oliver North, in his 'Rambles after Sport,' published at the 'Field' office in 1874, gives an excellent chapter on punting, entitled 'A Week's Duck Shooting at Poole.'

Thompson's 'Natural History of Ireland.'—A valuable and now scarce work, containing a marvellous amount of information about wildfowl which is interesting to gunners. There are also many notes about punt shooting, good bags and successful sport with big guns. It was published by Reeve, Benham, and Reeve, London, 1849. It is a prize which a wildfowl shooter should endeavour to procure. Its price is from 3*l.* to 3*l.* 10*s.*, but we have seen a set of the four volumes offered as low as 2*l.*

Maxwell's 'Field Book of Sports and Pastimes.' Published by E. Wilson, London, in 1833.—Herein we have numerous notes on fowling and gunning—the bulk of them copied from the works of Daniel, Hawker, &c. This book is by the author of one of the most charming sporting works ever written—we allude to 'Wild Sports in the West of Ireland.'

'The Sportsman's Library.' By John Mills. Published by W. Tait, of Edinburgh, in 1855.—Contains a few pages on

shooting wildfowl with a big gun, again chiefly extracted from our old friend Colonel Hawker.

'Shooting Simplified,' by 'Dougall.' Though wildfowl shooting is herein but lightly touched upon, this is one of the most practical works of its kind we possess.

In various numbers of the 'Sporting Magazine' there are some capital narratives of punting, evidently written by gunners of practical experience. For example :—

'Adventures and Experiences in Wildfowl Shooting.' By 'Hoary Frost.' February 1862, December 1862, January 1863, February 1863, March 1863.

'Wildfowl and the Art of Fowling.' January 1864, February 1864, March 1864. The author of these three papers does not give his name, but is a 'master of the craft.'

There are other writers in our sporting library that treat of wildfowl shooting, but they do so in such an antiquated and inaccurate manner that they are not to be named with even the least interesting of those here quoted.

R. P. G.

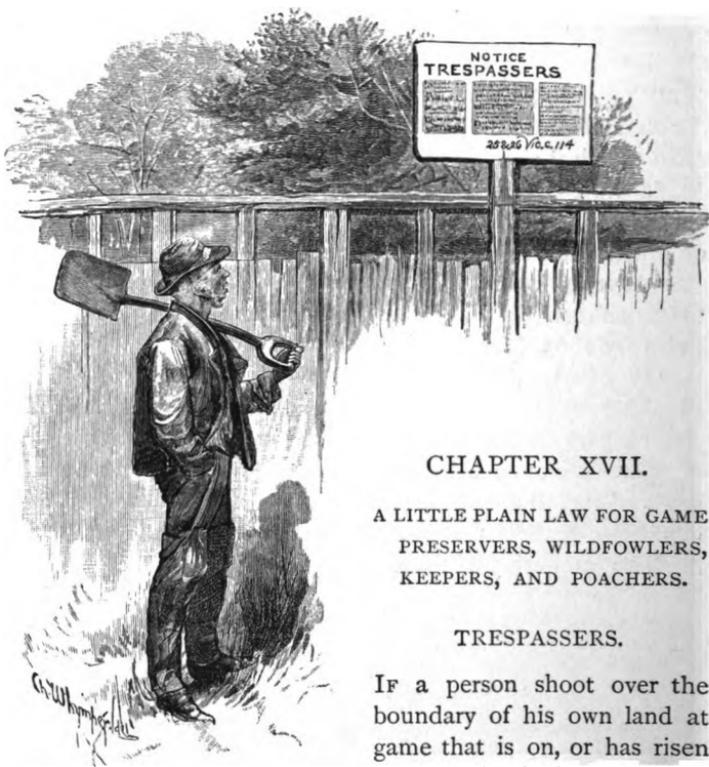

CHAPTER XVII.

A LITTLE PLAIN LAW FOR GAME PRESERVERS, WILDFOWLERS, KEEPERS, AND POACHERS.

TRESPASSERS.

If a person shoot over the boundary of his own land at game that is on, or has risen from, the land of another, and then goes to pick it up or sends his dog for it, he is a trespasser, and may be summoned.

But if a person fire at a bird that rises on his own land, and then falls dead or wounded on the land of another, whether it be killed over the boundary or not he may pick it up, and take or send a dog into his neighbour's land without committing a trespass.¹

¹ This right is liable to be, and sometimes is, abused. For instance, a poaching gentleman farmer of our acquaintance was in the habit of firing at birds going towards a neighbour's ground, whereon game was very abundant. He then followed the supposed dead or wounded partridge across the boundary, and while really searching for it, or pretending to be so occupied,

When crossing a boundary for such a purpose, make a point of leaving your gun on the ground over which your right of shooting extends.

Some poachers think they are safe when on a high road so long as they are not seen to leave it. It should be borne in mind that any poacher who shoots from the road, or sends a dog to hunt over land through which the road passes, may be summoned for trespass in pursuit of game; in the latter case as if he had himself accompanied the dog.

It is also worth noting, especially by keepers and watchers, that should a band of men go out poaching by day or night, any one, or all of them, may be summoned for trespass in pursuit of game so long as one of their number actually commits a trespass, and his companions are evidently assisting him as accomplices.

This law greatly strengthens the powers of landlords and keepers, and is a very useful one, though not generally known; it being commonly supposed that, unless a poacher be actually surprised in the act of trespassing when out with a confederate who is seen so to offend, he cannot be prosecuted.

If there be a ditch and hedge dividing the land of two owners, the edge of the ditch that is the farthest from the hedge is the exact boundary.

NIGHT POACHING.

For destroying game or rabbits by night, or for being on land by night with any gun, net, &c., for such a purpose, a poacher may be, for first offence, imprisoned with hard labour for any period not exceeding three months, and at the expiration of the term be made to find sureties, himself in 10*l.* and two in 5*l.* each, or one surety in 10*l.*, that he will not so offend again within a year's time; in default of his producing sureties, he

flushed a great many birds that would fly (as he designed they should) over the boundary on to his own small extent of ground—ground, too, planted with such a crop as would tempt them to remain. Notice-boards as applied to common trespassers must in such cases be resorted to.

may be sentenced to an additional imprisonment of six months, or until such sureties be found by him.

For a *second offence*, a poacher may be imprisoned with hard labour for any period not exceeding six months, his sureties being himself in 20*l.* and two others in 10*l.* each, or one of 20*l.*; against the offence being repeated within two years. In default



A Poaching Loafer.

of his producing sureties additional imprisonment of a year, or until he can find the required sureties. For a *third offence*, which is a misdemeanour, penal servitude for seven years, or imprisonment with hard labour for any period not exceeding two years.¹

¹ The law properly regards night poaching as a very serious offence. To night poaching is due the long list of murders and crimes connected with game-preserving. Day poachers do not go about in gangs; night poachers under

Night as construed by the Game Laws begins with the expiration of the first hour after sunset, and ends at the beginning of the last hour before sunrise. It is therefore of great importance that a keeper or watcher should make a careful note (written down at the moment if possible) of the time a poaching offence is committed, with a view to future proceedings against a delinquent.

If a poacher be found in the act of night poaching, and if the keeper or his assistants, in endeavouring to apprehend or identify him, be assaulted by him with gun, stick, or other weapon, a sentence of penal servitude for seven years may be inflicted, or imprisonment with hard labour for any period not exceeding two years.

If a *band* of poachers, consisting of three or more, go out by night for the purpose of taking game, armed with guns, bludgeons, or other weapons, they are liable to penal servitude for a term not exceeding fourteen years or less than seven, or they may be sentenced to imprisonment with hard labour for any period not exceeding three years, whether they assault the keepers or not.

DAY POACHING.

Day poaching, not being of so serious a character as night poaching, nor so dangerous an avocation, is treated by the law far more leniently than poaching by night.

Trespass in pursuit of game by day is punishable by a fine not exceeding 2*l.* and costs.

Where five or more persons poach by day in company each may be fined a sum not exceeding 5*l.* and costs.

If a trespasser refuse to give a gamekeeper, or other authorised person, his name and address, or give a false name, he is liable to a further penalty not exceeding 5*l.* and costs.

cover of darkness do, and the latter are often ready to assault or even murder at a moment's notice if interfered with by a smaller body of men than themselves.

APPREHENSION OF OFFENDERS.

The occupier of land, or person having the right of shooting on it, or any person authorised by either of them, may apprehend by day a trespasser in pursuit of game *only* if the trespasser refuse to give his address, or give a false address, or continue trespassing after first being warned. A trespasser, if taken into custody, cannot, however, be detained for more than twelve hours; he must be brought before a justice within that time, or else he will have to be discharged and afterwards summoned.

A person who has merely a right of shooting cannot himself, nor can his keepers or assistants, apprehend any one poaching by night; to do this he must be the occupier or owner of the land.

Any person, whether landlord, gamekeeper, or watcher, may apprehend (if he can) three or more poachers engaging in night poaching, if the latter are armed, wherever they be.

Game or rabbits that have been recently killed may be taken from a trespasser by the person who has the right of shooting over the land trespassed on, and his keeper can do this also.

A lord of a manor, or his gamekeepers duly appointed, can only seize dogs and nets from a trespasser when it is known that the poacher has not a license to kill game, and this of course can only be done on the manor in question. The gamekeepers of a person who is not lord of the manor he shoots over cannot legally take away a dog or net from a poacher, even though they know the poacher has no license to kill game.¹

¹ In taking a gun by force from a desperate poacher a keeper might run serious risks, and so the law does not encourage such an act. A poacher does not generally know this, however, and should be requested by a keeper to give up his gun. A keeper who catches a man in the act of poaching may make this demand, and the poacher is in consequence restricted from the use of the weapon for a time, if indeed he ever recover it, which he cannot do without bringing an action in the county court.

POACHING PREVENTION ACT.

Any *constable* in Great Britain and Ireland is authorised to search any person, in any highway, street, or public place, whom he may have good cause to suspect of coming from any land where he may have been unlawfully in search or pursuit of hares, pheasants, partridges, eggs of pheasants and partridges, woodcocks, snipe, rabbits, grouse, black or moor game, or eggs of the two latter birds, or any person aiding or abetting such person, and having in his possession any game unlawfully obtained, or any gun, part of gun, or nets or engines used for the killing or taking of game, and also to stop and search any cart or other conveyance in or upon which he shall have good cause to suspect that any such game or any such article is being carried by any such person.

Should the constable discover any game, or article as aforesaid, on any such person, cart, or other conveyance, he may seize and detain it.

It is necessary for a conviction under this Act that the game, or instruments for killing game, shall be found on the accused or in the cart, and seized by the constable whilst in the highway.

The constable must summon such person before the justices; and if it be proved that such person obtained the game by unlawfully going on any land in search or pursuit of it, or shall have used any such article as aforesaid for unlawfully killing or taking it, or shall have been accessory thereto, he shall forfeit a sum not exceeding 5*l.*, together with such game, guns, parts of guns, nets, &c.

The justices, in case of the conviction of the offender, shall direct any game, gun, or other article so taken to be sold or destroyed. If no conviction take place, the game or any other article, or its value, is to be restored to the defendant.

It will be seen that the Act above referred to gives very extensive powers to constables, but does not give any additional authority to gamekeepers.¹ Should a gamekeeper, however, suspect any person he should at once communicate with a constable, and the latter may, if he thinks the gamekeeper's suspicions well founded, search as above directed.

¹ So far as gamekeepers are concerned game is defined to include only hares, pheasants, partridges, grouse, moor game and bustards.

A gamekeeper may kill a dog when found destroying the rabbits in a warren, or when chasing deer in a legal park (i.e. an enclosure by grant of the Crown with deer therein); he may not kill the dog when merely hunting in the woods or on the fields of his (i.e. the gamekeeper's) master. It is very doubtful if it is lawful for a keeper to shoot a dog when his doing so is the only means of saving the life of the game pursued, and the owner of the dog may sue the keeper in the county court and possibly recover its value should he do so. In a reported case, '*Vere v. Lord Cawdor*,' Lord Ellenborough said: 'The question is whether the plaintiff's dog incurred the penalty of death for running after a hare in another's ground. And if there be any precedent of that sort, which outrages all reason and common sense, it is of no authority to govern other cases. The gamekeeper had no right to kill the plaintiff's dog. Gamekeepers are empowered by Act of Parliament to destroy trespassing dogs under special circumstances. These powers would not have been given had the gamekeeper previously a general right of destroying dogs.' Therefore a person may not shoot a dog. Anyone doing so, except in the cases specially mentioned in the Act of Parliament, is liable to action for the value of the dog.

It is unlawful to set 'mantraps,' but not so to set dog-spears in a wood, and the owner of a trespassing dog which has been injured or killed by running against a spear cannot recover compensation, though no warning notice was exhibited.

GAME, GUN, AND DOG LICENSES.

A license in Great Britain, or a certificate in Ireland, is required to be taken out by every person who shall use any dog, gun, net, or other engine, for the purpose of taking or killing game, woodcock, snipe, quail, landrail or rabbits.

In the following cases, however, no license is required:—

1. Persons taking woodcock and snipe with nets or springs in Great Britain (but not in Ireland).

2. The proprietor of a warren, or of any enclosed ground, or a tenant on his own land, or others with his permission, taking or killing rabbits.

3. Persons coursing, or hunting hares with beagles or other hounds.

4. Persons hunting deer with hounds.

5. The owner or occupier of enclosed land taking or killing deer by himself, or by others having his permission, on his own land.

The following persons are exempted from taking out a license to kill game :—

1. Members of the Royal Family.

2. Gamekeepers for Crown lands.

3. Persons assisting (otherwise than with guns) a duly licensed person to kill game. This exception includes beaters, stops, &c.

4. Any person in the actual occupation of enclosed land, or the owner who has the right of killing game on enclosed land, may himself kill hares on the enclosed land, or may in writing authorise any other person to do so ; but such authority must be limited to one person at the same time in any one parish, and must be sent to the clerk of the justices of the petty sessional division within which the land is situated for registration.

The *duties* to be paid for licenses or certificates to use any dog, gun, net, or other engine, for the purpose of taking or killing any game whatever, or any woodcock, snipe, quail, or landrail, or rabbit, or deer, or for taking and killing, or for assisting in any manner to take or kill any game, &c., are as follows :—

If the license or certificate be taken out after July 31, and before November 1 :

To expire on July 31 of the following year, 3*l*.

To expire on October 31 in the same year in which the license or certificate be taken out, 2*l*.

If such license or certificate shall be taken out on or after November 1:

To expire on July 31 following, 2*l*.

A license or certificate to kill game may also be taken out for a continuous period of fourteen days, to be specified in such license, on payment of 1*l*.

Any person having the right to kill game on any lands may take out a license for any servant for whom he shall pay tax as a gamekeeper to kill game on the same lands upon payment of the duty of 2*l*.

If the gamekeeper for whom a license has been taken out leaves his employment before the license has expired, it may be renewed in favour of his successor without further charge.

A gamekeeper's license does not allow him to kill game, &c., on land on which his master has not the right of killing game.

An annual license, other than a gamekeeper's, to kill, carries with it a license to sell game to any person licensed to deal in game.

A gamekeeper with a gamekeeper's license may sell game to a person licensed to deal in game, but only on behalf of the person whose gamekeeper he is.

Gun License.—Every person who uses or carries a gun, otherwise than within a dwelling-house or the curtilage thereof, must take out a yearly license, for which the duty is 10*s*.

A gun license expires on July 31 next following the date thereof.

The penalty for using or carrying a gun without a license is 10*l*.

Exemptions.—The following need not take out a gun license:—

1. Any person in the navy, army, volunteers, or constabulary, using a gun in the performance of his duty, or at target practice.

2. Any person having a license to kill game.
3. Any person carrying a gun belonging to a person who has a license to kill game, for the use of the person so licensed ; as, for instance, a loader.
4. The occupier of any land using or carrying a gun for the purpose only of scaring birds, or of killing vermin on such land, or any person using or carrying a gun for the purpose only of scaring birds or of killing vermin on any lands by order of the occupier who shall have in force a license to kill game or a gun license.

If a gun be carried in parts by two or more persons, each person is deemed to carry the gun.

Any officer of Inland Revenue, or any officer of constabulary, or any constable, may require any person carrying a gun to produce his license.

Any person refusing to produce his license on the demand of such officer, or refusing to give his name and address, or giving a false name, is liable to a penalty of 10*l.* ; such officer may arrest a person so refusing, and take him at once before a justice, who may convict him and fine him 10*l.*, or a mitigated portion of 10*l.* not less than one-fourth, and, in default, may commit him to prison for any period not exceeding one month nor less than seven days, according to the scale now in force, or until the penalty shall be sooner paid.

Any person who has a license to kill game, on conviction for any offence under any of the Game Acts forfeits his license to kill game.

Dog Licenses.—An annual license is required for every dog kept ; the duty to be paid for each license is 7*s.* 6*d.*

Puppies under the age of six months are exempt from this duty.

A master of hounds who has taken out proper licenses for all his entered hounds need not take out a license for any unentered hound under the age of twelve months.

A dog kept by a blind person for his or her guidance is exempt.

An exemption may be obtained for any dog used solely for the purpose of tending sheep or cattle. The penalty for keeping a dog or dogs without a license is a fine not exceeding 5*l.* for each dog so kept.

CLOSE TIME.

It is unlawful to kill any pheasants, partridges, grouse, moor-game or hares on a Sunday or Christmas-day.

Partridges may not be killed or taken between February 1 and September 1.

Pheasants may not be killed or taken between February 1 and October 1.

Black game may not be killed or taken between December 10 in any year and August 20 in the succeeding year; and in Devon, Somerset, and the New Forest between December 10 in any year and September 1 in the succeeding year.

Grouse may not be killed or taken between December 10 in any year and August 12 in the succeeding year.

Bustards may not be killed or taken between March 1 and September 1.

PENALTIES.

The penalty for killing or taking any game on a Sunday or Christmas-day is a fine, for every offence, not exceeding 5*l.* and costs.

The penalty for killing or taking game during the close time is a fine not exceeding 1*l.* for each head of game killed or taken, and costs.

It is illegal to use a gun or firearm of any description to kill game or rabbits by night.

Any dealer in game having any bird of game in his possession, or dealing with it, after ten days from the expiration of the season for lawfully taking or killing such game, and any other person after forty days from the expiration of the same

time, is liable to a penalty of 1*l.* for each head of game so dealt with or in his possession.

A person keeping game birds in a mew or pen for the purpose of breeding is not liable to this penalty. Nor is it an offence if a person who keeps live pheasants in a mew or pen for the purpose of breeding or stocking woods deliver them to a purchaser more than ten days after the season has elapsed, provided the purchase was made before ten days from the expiration of the season.

Hares and rabbits may be killed at any season of the year ; but hares being game may not be killed on a Sunday or Christmas-day.

WILD BIRDS PROTECTION ACT.

By an Act of Parliament for the protection of wild birds, which came into operation January 1, 1881, the protection of all wild birds during the breeding season is provided for.

By this Act any person who, between March 1 and August 1, shoots or attempts to shoot, or uses any boat for the purpose of shooting or causing to be shot any wild bird, or uses any line, trap, snare, net, or other instrument for the purpose of taking any wild bird, or exposes or offers for sale, or has in his control or possession after March 15 any wild bird recently killed or taken, shall, on conviction, *in the case of any wild bird included in the schedule* of the Act, pay for every bird in respect of which an offence has been committed a penalty not exceeding 1*l.* ; and *in the case of any bird not included in the schedule* shall for a first offence be reprimanded and discharged on payment of costs ; and for every subsequent offence shall pay a sum not exceeding 5*s.*, in addition to the costs, unless such person shall prove that the bird was killed, taken, bought, or received during the period in which it could be legally killed or taken, or that he received it from some person residing out of the United Kingdom.

The owner or occupier of any land, or any person authorised

by the owner or occupier of any land, is not liable to a penalty for killing or taking on such land during the close time any wild bird, such as wild geese for example, which is not included in the schedule.

The following are the birds included in the schedule to the Act :—

American quail.	Grebe.	Oyster-catcher.	Shoveller.
Auk.	Greenshank.	Peewit.	Skua.
Avocet.	Guillemot.	Petrel.	Smew.
Bee-eater.	Gull (except	Phalarope.	Snipe.
Bittern.	Black-backed	Plover.	Solan goose.
Bonxie.	gull).	Ploverspage.	Spoonbill.
Colin.	Hoopoe.	Pochard.	Stint.
Cornish chough.	Kingfisher.	Puffin.	Stone-curlew.
Coulterneb.	Kittiwake.	Purre.	Stonehatch.
Cuckoo.	Lapwing.	Razorbill.	Summer snipe.
Curlew.	Lark.	Redshank.	Tarrock.
Diver.	Loon.	Reeve or Ruff.	Teal.
Dotterel.	Mallard.	Roller.	Tern.
Dunbird.	Marrot.	Sanderling.	Thick-knee.
Dunlin.	Merganser.	Sandpiper.	Tystey.
Eider duck.	Murre.	Scout.	Whaup.
Fern-owl.	Night-hawk.	Sealark.	Whimbrel.
Fulmar.	Night-jar.	Seamew.	Widgeon.
Gannet.	Nightingale.	Sea parrot.	Wild duck.
Goatsucker.	Oriole.	Sea swallow.	Willock.
Godwit.	Owl.	Shearwater.	Woodcock.
Goldfinch.	Ox-bird.	Sheldrake.	Wood-pecker.

The close time under this Act may be varied or extended in any county by order of one of Her Majesty's principal Secretaries of State as to Great Britain, and the Lord Lieutenant as to Ireland, upon the application of the justices of such county in quarter sessions assembled.

And any county, or part of a county, may upon a similar application, when it appears desirable, be exempted from the operation of the Act as to all or any wild birds.

The protection given to birds by this Act does not, unfortunately, extend to their eggs; consequently eggs of birds

(except those protected, namely, of any bird of game, swan, duck, teal, or widgeon) may be taken or destroyed in the close time, though the birds themselves are protected. The sale of foreign birds of the species protected by the Act being permitted during close time is also a certain drawback to the efficiency of the protection accorded.

A gamekeeper will do well to observe that the law appoints a close time for crows, hawks, jays, magpies, and such like birds, hitherto unprotected, and that he is liable to be convicted for killing any of these between March 1 and August 1, unless with the authority of the owner or occupier of the land on which he kills the bird. A mere right of shooting on the land does not carry with it this authority. Owls, being included in the schedule, may not be destroyed during the close time even with the authority of the owner or occupier of the land.¹

Many species mentioned in the schedule appear under different names. This arrangement is a necessity, as birds are often known only by their local names, most of which are given above. If every person likely to be affected by the Act could recognise the same bird by the same name it would of course be needless to insert more than that one, but in many cases, especially on the coast, different names are in common use in different parts of the kingdom, hence the majority of shooters are not acquainted with the correct names of species, though perfectly familiar with a species under the name it is known by in the locality they chance to shoot in.

For instance, an involuntary offender in Scotland would receive small satisfaction from being informed that a name,

¹ Owls, which usually form a large proportion of the vermin exhibited by a keeper on wall or tree, do comparatively little harm to game, and, moreover, aid in saving young pheasants and partridges, for they destroy countless rats; one owl when it has young will kill as many as a dozen rats in a night. Keepers not only give themselves much unnecessary trouble by killing owls, but slay their best friends, for there is no doubt that rats not only play havoc with young birds, but also devour great quantities of pheasants' food.

through not knowing which he had incurred a penalty, was perfectly well known to people in the South of England.

Indeed, it often happens that the provincial names given in the schedule are the only names by which certain species are recognised by a great number of shooters.

For the convenience of those who wish to know local names, we give the following list :—

AMERICAN QUAIL (Colin).	NIGHTJAR (Goatsucker, Fern-owl, Nighthawk).
CURLEW (Whaup, Whimbrel).	POCHARD (Dunbird).
DIVER (Loon).	PUFFIN (Sea Parrot, Coulter-neb).
DUNLIN (Plovers-page, Purre, Sea-lark, Stint).	RAZOR-BILL (Marrot, Murre).
GANNET (Solan Goose).	RINGED PLOVER (Stonehatch).
GREBE (Loon).	SANDPIPER (Summer Snipe).
GUILLEMOT (Murre, Scout, Willock).	SKUA (Bonxie).
GUILLEMOT-BLACK (Tystey.)	TERN (Sea Swallow.)
GULL (Sea-mew).	THICK-KNEE (Stone Curlew, Norfolk Plover).
KITTIWAKE (Tarrock).	
LAPWING (Peewit, Plover).	

That this Act has been the cause of much adverse criticism is well known ; but it has usually been condemned by those who do not understand its provisions, and who are forgetful of the fact that it was drawn up with great care by most of the best naturalists of the day, assisted by practical sportsmen, with a view to protecting our wild birds generally, and to save our songsters and rare visitors from the extinction that previously threatened them.

It is no doubt a matter of regret that the eggs of wild-birds could not be protected ; but it is not possible to carry out the utmost wishes of enthusiasts ; and the strong repugnance shown by Parliament to any proposition which would be likely to produce a large number of juvenile offenders is very natural even were it possible that such a law (as in the case of plovers' eggs) could be enforced.

We would suggest, however, that should this Act be

amended the interests of the coast-fowlers ought to be taken into account more than they have been hitherto.

For example, brent geese cannot be killed after March 1 by fowlers. If these birds ever nested in our islands there would be good reason for protecting them within certain dates, as birds that do breed with us are protected.

Now brent geese frequent our shores in thousands throughout the month of March, each bird being worth a day's support to a poor shooter. But the fowlers are prosecuted if they kill them, and can only gaze with longing eyes at a source of food and income unnecessarily denied by law.

Brent geese are a very distinct species, and keep apart, unlike, for example, widgeon (which though they seldom nest with us associate with other ducks that do), and would not therefore offer the fowlers an excuse for breaking the law in regard to the killing of other birds that certainly require protection, as wild duck, teal, &c.

It is worthy of mention that wild birds may be killed on both March 1 and August 1.

THE GROUND GAME ACT.

The words Ground Game for the purposes of this Act mean hares and rabbits. Under this statute every occupier of land has the right to kill ground game on his land concurrently with any other person (such as his landlord) who also has the same right, subject to the three following limitations.

(1) The occupier may kill and take ground game only by himself or by persons authorised by him in writing.

(a) The occupier, and one other person authorised by the occupier in writing, can alone use firearms to kill ground game.

(b) An occupier cannot give general permission to his friends to kill ground game for him, as he can only authorise members of his household resident on the land, persons in his ordinary service on the land, or some one especially employed for killing ground game,

to do so. He cannot let or give the right of killing ground game save to the persons just mentioned.

(c) Every person so authorised by the occupier, on demand by any person having a concurrent right to take and kill the ground game on the land, or any person authorised by him in writing to make such demand, shall produce the document by which he is authorised, and in default thereof he shall not be deemed an authorised person.

(2) A right of common over land, or the occupation for the purpose of grazing or pasturage for not more than nine months, does not give any right to kill ground game.

(3) In the case of moorlands and unenclosed lands (not being arable lands), the occupier and the persons authorised by him may exercise the right of killing or taking ground game only from December 11 in one year until March 31 in the next year, both days inclusive. This limitation does not apply to detached portions of moorlands, or unenclosed land adjoining arable land when they are less than twenty-five acres in extent.

When the occupier of land is entitled independently of the Act to kill ground game on the land in his occupation, and gives any other person that right, he shall nevertheless retain and have, as incident to and inseparable from such occupation, a concurrent right to kill ground game.

All agreements in contravention of the right of the occupier under this Act to destroy ground game are void.

The occupier and persons duly authorised by him are not required to take out game licenses for the purpose of killing ground game under the Act; and the occupier may sell the ground game killed by him, or by persons authorised by him, without a license; but neither the occupier nor persons authorised by him are exempt from the Gun License Act.

If at the date of the Act coming into force (September 7, 1880) the right to kill and take ground game was vested by lease, contract of tenancy, or other contract *bonâ fide* made for valuable consideration, in some person other than the occupier, the latter's right does not accrue until the determination of the contract.

A tenancy from year to year is, for the purposes of the Act, deemed to determine at the time when such tenancy would by law become determinable if notice had been given at the date of the passing of the Act.

No person having a right to kill ground game under this Act or otherwise may use firearms to kill ground game between the expiration of the first hour after sunset and the beginning of the last hour before sunrise ; and no person may employ spring-traps to kill ground game except in rabbit-holes, or employ poison.

The penalty on conviction for any of these three offences is a fine not exceeding 2*l.*

The setting of spring-traps above ground is punishable under the Ground Game Act only in the case of a person having the right to trap on the land ; therefore a trespasser setting spring-traps above ground cannot be proceeded against under this Act, though a keeper doing so, even with the consent of the owner and occupier, is liable to a penalty.

Traps set above ground cannot be detained under the Act.

A person who is not in occupation of the land, but has the right of killing game on it, has the same authority to institute proceedings against trespassers in pursuit of game as an exclusive owner has, subject, of course, to the occupier's rights given by the Act.

This Act does not authorise the killing or taking of ground game on any days or seasons or by any methods previously prohibited ; for example, an occupier is not permitted to kill a hare on Sunday or Christmas-day.

It will be seen that there are some very important changes in the law introduced by this statute ; the most important, perhaps, of those which affect the duties of a gamekeeper is that it is now unlawful for anyone to set a spring-trap for ground game except in a rabbit-hole (though of course he can do so for birds or for vermin or animals other than hares or rabbits), and a keeper renders himself liable to a penalty of 2*l.* for doing

so. Runs under wire-netting are not holes within the meaning of the Act, consequently spring-traps may not be set in them. It is unlawful, too, for a gamekeeper (or anyone else) to use firearms by night to kill rabbits.

Killing game (including hares) by night with firearms was previously illegal.

A curious oversight in the Ground Game Act is that a trespasser, or a person who has not the right of killing ground game, cannot be proceeded against under the Act. We will conclude this chapter with a few remarks concerning this Act, one that has proved more vexatious and useless, and has caused more idleness and ill-feeling, as well as deterioration in the value of sporting and other property, than any Act connected with landlord, tenant, or game that has been passed within the present century.

It is impossible to regard the Ground Game Act as conferring an unmixed advantage on those in whose interest it was supposed to have been passed. It certainly has proved to be the cause of a great deal of ill-feeling between keepers and tenants (who ought to be on the best of terms), and has not unfrequently been productive of a positive loss to the tenants. As an example of one of many instances of the kind which have come within our own experience, we give the following:—A landowner of our acquaintance had a large outlying farm which he let with the shooting to a farmer. After the passing of the Ground Game Act, the tenant made application to his landlord for a reduction of 100*l.* per annum in his rent *in consequence of the Act*. On investigation, his application seemed consistent with common sense. It appeared that he was in the habit of annually letting the shooting of his farm to some manufacturers living in a neighbouring town for 200*l.*, consequently reducing the rent he paid his landlord by that sum.

On the passing of the Ground Game Act, the shooting tenants very naturally said, 'Your shooting is not worth what it was by half, for you have the power (which you may exer-

cise at any time and cannot divest yourself of) to kill all the ground game which you have hitherto given us the exclusive right to kill, as well as to drive off winged game by shooting on the farm ; we will give you 100*l.* for the limited right which it is now in your power to let, but no more.' Hence the not unreasonable application of the farming tenant to have his rent reduced by 100*l.* ; the amount of loss arising from the deteriorated value of the shooting.

On some estates the Act is practically a dead letter, the good old feeling between landlord and tenant being maintained to the mutual advantage of both ; but on other estates (more especially where the shooting is let) there is a continual friction between the landlord (or the shooting tenant where the sporting rights are let) and keepers on one side, and the farming tenants on the other ; the landlord being continually in danger of losing the farming or shooting tenant, possibly both, which in these hard times he can ill afford to do.

Another hardship to which a farmer has to submit under this Act, and which is quite untouched by it, is the case of a farm adjoining a covert belonging to a different owner. Formerly, on the farmer complaining of damage done by ground game, the neighbour was usually willing to do what he could by keeping down the rabbits within reasonable limits. Now the obvious answer to the farmer is, 'You have the power to kill the ground game yourself ; once the game is on your land it no longer belongs to me.' The farmer, it is true, can snare a few of the trespassing rabbits on his land so situated, but he is unable to get at their earths, which are of course in the covert ; and before he has made any appreciable reduction in their numbers they may have completely destroyed his young wheat.

An anecdote may here be inserted bearing on this Act in regard to keepers during a recent election. A politician who made a point of canvassing wherever he went, solicited the vote of the head gamekeeper where he was shooting, for the local Conservative candidate. The following dialogue took place.

Keeper. 'Well, sir, I be going to vote for Mr. —— (the Conservative candidate) and so be all my mates.'

Canvasser. 'Quite right. Mr. —— is pledged to support Lord Salisbury and his foreign policy, is——'

'Lord, sir,' interrupted the keeper, 'we don't know nothing about no foreign policy; it was because they passed that —— Ground Game Act we won't vote for t'other party.'

R. P. G.

INDEX.

ACC

ACCIDENTS, 19, 24, 34
American widgeon, 178
Ammunition box, 287
Anchors, 287
Ardilaun, Lord, game book
 quoted, 123
Ashby decoy, 175
Avocet, 209

BAGS for cartridges, 287

Baillon's crake, 221
Batteries, 12, 15-20, 21
Beagles, 323
Bean goose, 258
Beaters, 33, 74-76
Bernacle goose, 160
Bewick's swan, 156
Bittern, 217, 218
Black-gamc, 45; failure to introduce in Ireland, 45; habits, 45; a black-cock parliament, 45; pugnacity, 46; nesting, 46; eggs, 46; moulting, 46; food, 47; poaching, 47, 49; causes of decline in numbers, 47; crosses, 47, 48; date for shooting, 48; stupid on stubbles, 48; best shooting ground, 49; ruses for attracting birds, 49; driving, 49-52; direction of flight, 49;

II.

CAP

best conditions for shooting, 50; stupid stalking, 50; placing guns, 51; use of flankers, 51; the quiet style, 51; colours of flags, 51, 52; the novice at work, 52; following the bird with the gun, 52; legislation concerning, 326
Blackwater, the, 304, 307
Blenheim, sport at, 143
Blisters, 77
Boats, following punts, 290
Booth, Mr. E. T., of Brighton, quoted, 40
Brass cartridge cases, 232; *see* Cartridges, vol. i.
Breechloaders for punts, 274-288
Brent geese, 161, 245, 331
Bristol Channel, the, 306
Buckle, puntsman, 311
Buffel-headed duck, 189
Bustards, 326

CAPERCAILZIE, 53; disappearance from and re-introduction in Scotland, 53; habits, 54; pugnacity, 54; food, 54; breeding, 54; sport at Dupplin, 55, 56; vulnerable places

Z

CAP

to hit, 55; care in handling wounded birds, 55; flight, 56; value for the table, 56
 Caps, 250
 Cartridges, 288; *see* vol. I.
 Castor oil, 290
 Christchurch Bay, 305
 Close time, 326
 Clothing, 77, 250, 288
 Collies, 76,
 Collinson, Joseph, keeper, 37
 Coot, 222-224, 239
 Cork cushion for punts, 290
 Cormorants, 56
 Coursing deer, 72
 Crane, Baillon's, 221; little, 221; spotted, 220
 Cripple-stoppers, 289, 291, 295
 Curlew, 215, 226, 236

DABCHICK, 201

Decoys, 175

Dee, the, 306

Deer, and deer stalking, 57;
 early methods of killing, 57;
 preservation of, 58; ancient forests, 58; 'Tainchel,' 59; Taylor the water poet's description of a royal hunt in 1618, 59; stalking in olden times, 60; pleasures of stalking, 62; true sport, 62; habits of red deer, 62; calving, 63; the young calves, 63; watchfulness of hinds, 63; growth of horns, 63-65; shedding antlers, 64; what constitutes a good head, 64, 65; deteriorated condition of stags during the period of horn-growing, 65; Hummle or hornless stags, 66; one and three-horned, 66; sport

DEE

on the hills, 66, 68; in the woods, 67; attacks from eagles, 68; separation of stags from hinds, 68, 70; stags shifting ground, 69; sea-bathing for health, 69; break up of large herds, 70; a stag's fag, 70; a royal's compassion for a youngster, 70; fidelity among deer, 71; coursing, 72; one mode of driving, 73-75; another method, 75; driving and stalking woods, 75; difference between hinds' and stags' tracks, 76; tracking with dogs, 76; 'moving' deer, 77; best dress for hard work on the hills, 77; to prevent feet blistering, 77; signalling with handkerchief, 78; to allay thirst, 78; susceptibility of deer to unusual sounds, 78-80; the sky line, 79; keen sight and hearing of deer, 79, 80; love of music, 80; acute sense of smell, 80, 81; preparations for the stalk, 81-83; use of the glass, 82; observation of ground, 82; formation of guns, 83; stumbling and recovering, 83; nearing the stags, 83, 84; deliberation in aim, 85; approaching the wounded, 85, 86; using the knife, 86; gralloching, 87; points of a good stag, 87; points of hinds, 88; thinning down stock, 88; judging distance when firing, 88, 89; downhill shots, 88, 89; where to place the bullet, 89; gun rests, 89, 90; firing at running quarry, 90; crawling, 84, 90; putting

DEE

the stag up, 91, 92; a clever ruse, 92; the rutting season, 93; deer among corn, 93; fencing for arable land, 93; stags guarding hinds, 94; fight between two mighty harts, 95, 96; points of a good rifle and how to use it, 97; the single Henry rifle, 97; bullets, 97, 98; following wounded animals, 90, 98-100; slipping deerhounds at wounded, 99; legislation concerning, 323

Deer-forests, definition of, 101; sheep on, 101; destruction of timber, 102; number and value, 102; qualities entitling to the term first class, 102, 104; burning the heather, 103; cotton grass, 103; grouse on, 103; necessity of low meadows, 104, 110; the sanctuary, 104; deer shifting ground, 104; favourite spots of herds, 105; selection of stags, 105; introduction of park stags from England, 106; division into beats, 106; work of the forester, 106; paths, 106; acreage required for deer, 107; letting prices and proprietary expenses, 107; the question of disafforesting, 107; sheep *v.* venison, 108, 111; a Highland glen in olden times, 108; impossibility of limiting deer to the high ground, 110; remunerative form of employing land to owner and neighbourhood, 110; legislation for tourists, 110; money expended by tourists contrasted with

DUC

expenditure incident to forest, 111; disturbance of deer and their desertion of beat, 111

Deerhounds, 72, 82, 99

Derbyshire, sport in, 15, 19

Divers, 196; *see* Diving ducks

Diving ducks, varieties, plumage, and habits of different species, 185-201; pochard, 186; netting, 186; red-crested pochard, 187; ferruginous, 187; scaup, 187; tufted, 188; golden-eye, 189; buffel-headed, 189; long-tailed, 190; harlequin, 190; Stetter's Western, 190; eider, 191; common or black scoter, 191; velvet scoter, 192; surf scoter, 192; merganser, or saw-bill, 193-195; goosander, 193; red-breasted mergansers, 194; hooded mergansers, 195; smews, 195; divers, 196-198; great northern diver, 196; red-throated diver or loon, 198; black-throated diver, 198; grebe, 199; great crested grebe, 200; red-necked grebe, 200; eared grebe, 200; Slavonian grebe, 200; little grebe or dabchick, 201

Dog licenses, 322-325

Dogs, employment of, in sport, 1-4, 7-10, 38, 40, 41, 76, 99, 100, 131, 226, 228, 230, 322, 323, 325, 326; *see* vol. i.

Dotterel, 206

Dressing for boots, 290

Drivers, 17, 31-33, 37, 51

Driving, 49, 50

Dress, 77, 250

Duck; *see* Surface feeding ducks and Diving ducks

DUN

Dunbird, 186
 Dunlin, 213
 Dupplin, sport at, 55

EAGLES, 63, 68
 Eider duck, 191
 Estuaries, British, where punt-
 ing is carried on, 303-308

FENCING, 93

Ferruginous duck, 187
 Field glasses, 286
 Field pads, 282
 Flags, 32, 33, 51, 52
 Flannel, 251, 288
 Foresters, duties of, 103, 104,
 106; *see* Deer forests

GADWELL, 179; *see* Surface-
 feeding ducks

Gallwey's, Sir Ralph, indicator,
 23

Game licenses, 322

Garganey, 183; *see* Surface-
 feeding ducks

Germany, migration of birds
 from, 117, 139

Gillies, 41, 81, 83

Godwit, 216; *see* Waders

Golden-eye duck, 189

Goosander, 193; *see* Diving
 ducks

Gore-Booth, Sir H., quoted, 161

Gralloching, 87

Grant, Sir Francis, quoted, 174

Grebe, 199

Greenshank, 209; *see* Waders

Greylag, 166; *see* Wildfowl

Ground Game Act, 331-335

Grouse, and grouse shooting, 1;
 use of dogs, 1; driving, 2;

GRO

change in habits, 2; contrast
 between English and Scotch
 birds, 3; food, 3; burning
 the heather, 3-6; poaching,
 4, 6; the epidemic and tape-
 worm, 4; parasites, 5; un-
 healthy heather, 5; injurious
 effects of long-continued frost,
 6; agricultural gunners, 6;
 over-preservation, 6, 7; shoot-
 ing over dogs, 7; working
 the dogs in relays, 8; best
 ground to find birds, 9; Mr.
 Spencer Stanhope's letter on
 introduction of driving, 11;
 Sir William Cooke and his
 flint gun, 11; George Sykes,
 12, 13; increase of birds
 through driving, 12; pugna-
 cious nature, 12, 13; homing
 instincts, 14; long drives, 14;
 backward and forward drives,
 15; shooters' shelters, 15;
 constructing batteries, 15-17;
 placing batteries, 17-20; dis-
 tance between batteries and
 keeping in true line, 20; one
 advantage of muzzle-loaders,
 20; dangers of double line
 of batteries, 20; picking up
 birds, 20, 21; clearing ground
 round batteries, 21; use of
 retrievers, 22; reckoning birds
 killed, 22; Sir R. Payne-
 Gallwey's indicator, 23; Mr.
 Speedy's method of showing
 the position of fallen birds,
 23; angles at which to hit
 birds, 24, 25; force of falling
 birds, 24; killing birds flying,
 25; taking birds in line when
 turning, 26; putting the gun
 to the shoulder, 26; offices
 of the hand, eye, and brain in

GRO

- shooting, 27; shooting driven birds, 27-29; hints to gunners, 30; tendency of birds to escape at sides of a drive, 30; number and position of drivers, 31, 32; use of flags, 32; birds cannoning, 33; spoilt drives, 33; guarding against accidents to beaters, 33; shot suitable, 34; idiosyncrasies of individual sportsmen, 34; making use of opportunities, 35; problems for the archæologist of the future, 35, 36; remarkable bags, 36, 37, 38; legislation concerning, 326
- Gun licenses, 324
- Gunmakers—Holland, 275, 276, 283, 285; Patstone, 292; Trulock and Harriss, 284; *see* vol. i.
- Gunpowder, 148, 295; Gallwey's, 282, 284; Lantour's, 283, 295; Hawker's, 283-285, 295; *see* vol. i.
- Guns for woodcock, 132; for snipe, 147; for wildfowl, 232-234; *see* vol. i.
- Gun slings, 233
- Guthrie, keeper, 53
- HALLORAN, Patrick, snipe shooter, 140
- Hares, 52, 323, 327, 331, 334
- Harlequin duck, 190
- Harris and Lewis, sport on, 3, 126-128
- Harvie-Brown, Mr., quoted, 6
- Hawker, Colonel, cited, 160, 177, 243, 278, 279, 283-285, 307
- Hawks, 33

LAW

- Heather, 3-6, 103
- Heron Court, sport at, 235
- Herons, 33, 217
- High Force, sport at, 36, 37
- Highland traditions, 61
- Highlanders and deer-forests, 108; old and modern styles of life, 109
- Holkham, sport at, 126, 142, 235, 237
- Holland, sport in, 171, 177, 180, 211
- Holyhead, 306
- Humber, the, 304
- IBIS, glossy, 216; *see* Waders
- India, sport in, 143
- Ireland, sport in, 45, 114, 115, 122-125, 134, 140-142, 156, 160-164, 166, 167, 175-177, 179, 180, 183, 186, 187, 189, 191-199, 204, 206, 208, 211, 214, 215, 217, 221, 233, 237, 306, 307
- Irish spaniels, 230
- Italy, sport in, 237-239
- KEEPERS, employment and duties of, 2, 4, 8, 11, 12, 50, 236, 317, 319, 320, 324, 329, 333, 334; *see* vol. i.
- Kelpies, 61
- Knot, 212; *see* Waders
- Kynoch's brass cartridge-cases, 232
- LANDRAIL, 219
- Lapwing, 202; *see* Waders
- Law, for game preservers, wild-fowlers, keepers, and poachers, 316; concerning trespassers, 316; night poaching, 317-

LAW

- 319; day poaching, 319; apprehension of offenders, 320; Poaching Prevention Act, 321; game, gun, and dog licenses, 322-326; close time, 326; penalties, 326; Wild Birds Protection Act, 327-331; Ground Game Act, 331-335
- Liggin-hoiles, 16
- Lincolnshire, sport in, 134, 164, 175, 192
- Lloyd, Mr., quoted, 124, 142
- Loaders, 30
- Loch Rannoch, 55
- Long-tailed duck, 190
- Loons, 198; *see* Diving ducks
- Lynn punts, 314

MALLARD, 172

- Markers, 130
- Mergansers, 193-195; *see* Diving ducks
- Mersey, the, 306
- Milford Haven, 306
- Moorhen, habits of, 221
- Mud-boards, 294
- Mute swan, 157; *see* Wildfowl
- Muzzle-loaders, 20, 274-288

NEATSFOOT oil, 290

- Netting, 47
- Nile, punting on the, 262
- Norfolk, sport in, 125, 134, 140, 142, 164, 168, 179, 180, 185, 186, 188, 190, 192, 206, 211, 221, 234, 235, 304; *see* vol. i.
- Notice boards, to trespassers, 317

OVERALLS, 228, 251

- Owls, 329
- Oyster-catcher, 208; *see* Waders

PUN

- PADDLES, 294, 295
- Parasite, the grouse, 5
- Partridge, 326; *see* vol. i.
- Peewit, 198; *see* Waders
- Penalties, for illegal killing of game, 326
- Phalaropes, 214, 215; *see* Waders
- Pheasants, 326; *see* vol. i.
- Pigeons, 261, 262
- Pink-footed goose, 168
- Pintail, 179, 258, 261, 262; *see* Surface-feeding ducks
- Plovers, 205
- Poachers, 47, 49, 54, 60, 317-322
- Poaching, 4, 6, 47, 49
- Poaching Prevention Act, 321
- Pochard, 186; *see* Diving ducks
- Pointers, use of, 2, 8, 9, 41, 48
- Polish swan, 157
- Ponies, grouse parasites in, 5
- Poole Harbour, 305
- Ptarmigan, 38; best ground for, 38; season for shooting, 39; plumage, 39; protection afforded by assimilation of colour to rocks and snow, 39; advantages of change of plumage in summer and winter, 40; difficulty in finding sitting hens, 40; tameness, 40; wildness, 41; difficulties of pursuit, 41; flight, 41, 42; towering birds, 43; best ground in Scotland for, 43; pursuit in winter, 43; best bags, 44
- Punting, 241; fascination as a sport, 241-243; to shoot wildfowl with a swivel-gun, 243-245; single versus double handed, 246-249; clothing requisite, 250; the cap, 250;

PUN

flannel, 251; waterproofs and overalls, 251; food, 251; birds not to be disturbed during high water, 251; floating in range, 252; fowl on the alert, 252; in a gale of wind, 252; shooting at dawn, 252; by day, 253; spring-tides, 253; at night, 253; distance for shooting, 254; moment to fire, 254, picking up cripples, 255; uncertainty of the sport, 255; a model yacht, 256; extracts from diaries showing varying luck, 257-261; Lord Londesborough's bag on the Nile, 261, 262; action of fowler when paddling in single-handed punt, 266, 268; using the sculls and setting-pole, 269; working in double-handed punt, 271; accessories, 286-302; following boats, 290; estuaries where punting is chiefly pursued, 303

Punts, single-handed, 263; dimensions of a paddling, to carry a swivel gun from 80 to 112 lbs., 266; fast punt of same class, 266; for sculling and using a setting-pole, 268; double-handed, to take a gun of 130 to 170 lbs., 269; to take a gun of 80 to 100 lbs., 270; list of accessories, 286-302; cork cushion, 290; deck-rafters, 290; flooring boards, 290; mud-boards, 294; paddles, 294; rowing spurs, 297; rudders, 297; sail, 298; setting-pole, 299; stem and stern, 300; shutters, 301;

SHO

towing-rope, 302; Lynn, 314

RABBITS, 323, 326, 327, 331, 335; *see* vol. i.

Rails, 219-224

Ramrods, 295

Rats, 329

Redshanks, 209, 210; *see* Waders

Retrievers, 22, 226

Ribble, the, 306

Rifle, the single Henry, 97

Rooks, 47

Rowing spurs, 297

Rudders, 297

Ruff, 211; *see* Waders

Ryshworth, sport at, 12, 33, 35

SAIL, 298

Sanderling, 214; *see* Waders

Sandpiper, 210-213

Sandringham, sport at, 235

Scaup, 187; *see* Diving ducks

Scoters, 191; *see* Diving ducks

Scotland, sport in, 3, 14, 26, 36, 45, 49, 53, 57-111, 115, 143, 156, 160, 161, 164, 166-168, 174, 175, 177, 179, 180, 186, 187, 189-199, 204, 206, 208, 209, 211, 213-215, 217, 221, 303, 307; *see* vol. i.

Setters, 8, 41

Setting-pole, 299

Shelduck, 170

Shoes, 77

Shore shooting, wildfowl, 225; shore-shooters versus puntsmen, 226; attractions, 226; use of retrievers, 226; flighting by night and by day, 227; favoured by gales, 228; use

SHO

of white overall in snowy weather, 228; a thaw, 229; how to discover the night haunts of wildfowl, 229; on small meres and pools in preserved districts, 230; use of the Irish spaniel, 230; firing at ducks when fighting, 230-232; suitable guns, 232; Kynoch's brass cases, 232; single-barrelled guns, 232; slings, 233; caution in laying guns down, 233; a case of over-confidence, 233; large shoulder guns, 233; records of wildfowl shooting, 234-237; duck shooting, 235; in Italy, 237-239; coot, 239

Shot, 34, 133, 148, 228, 234, 235, 286, 300; *see* vol. i.

Shoveller, 180; *see* Surface-feeding ducks

Shutters, 301

Slings, gun, 233

Smew, 195; *see* Diving ducks

Snipe, 23, 127, 128; various species of, 134; the common or full, 134; breeding places, 134; arrival of migrants, 135; humming noise, 135; eggs, 135; feeding spots, 135, 136; favourite haunts, 136; erratic movements, 136, 137; weight of the common, 138; the jack, 138; great double or solitary, 139; Sabine's, 140; red-breasted, 140; shooting episodes, 140-143; in Ireland, 140-143; in Norfolk, 142; in Oxfordshire, 143; in India, 143; uncertainty in shooting, 144; speed and zigzag flight, 145; knack in killing, 146; 'forward and high aiming,'

SPO

146; on soft ground, 147; kind of gun to use, 147; shot, 148; use of spaniels, 149, 227, 236; legislation concerning, 322

Solent, the, 304, 307

Southampton Water as a feeding ground for widgeon, 177, 304

Spaniels, 131, 230, 149

Spoonbill, 216; *see* Waders

Sport, definition of, 62

Spring traps, 333

Spur strap for duck-boots, 301

Sportsmen and game preservers, past and present,—Ardilaun, Lord, 123; Athole, Duke of, 65; Beaufort, Duke of, 12; Berkeley, Mr., 125; Booth, Mr. E. T., 40; Booth, Sir Henry Gore, 123; Bowes, Mr., 12; Breadalbane, Marquess of, 53; Castletown, Lord, 237; Chesterfield, Lord, 19; Clermont, Earl of, 122, 124; Cleveland, Duke of, 12; Coke, Colonel, 235-237; Coke, Hon. E., 234; Coke, Hon. H., 235; Coke, Lord, 236, 237; Coke, Mr., 120; Cooke, Sir William, 11; Dalhousie, Lord, 36; De Moleyns, Hon. E., 141; Denny, Captain R., 141; Devonshire, Duke of, 12; Dunmore, Earl of, 36; Elcho, Lord, 123; Enniskillen, Lord, 123; Fellowes, Mr. R., 142; Fitzhardinge, Lord, 236, 237; Forbes, Mr., 37; Forbes, Mr. G., 37; Fraser, Colonel Alastair, 66; Gethin, Mr. Edward, 141; Gould, Captain, 282; Grazioli, Duke, 238; Hall, General, 12, 36;

SPO

Hastings, Lord, 125; Herbert, Mr., 123; Home, Earl of, 48; Huntingfield, Lord, 126; Ilchester, Lord, 235; Leathes, Colonel, 142; Leicester, Lord, 11, 126, 142, 235-237; Leslie, Mr. Charles, 24; Lindsay, Lord, 237; Londesborough, Lord, 261; Macdonald, Sir A., 235; Marjoribanks, Hon. Edward, 143; Milbank, Sir Frederick, 12, 37, 38, 69, 126; Newport, Viscount, 37; Odescalchi, Prince, 238; Oxenden, Mr., 125; Paget, Sir A., 238; Parker, Sir Hyde, 125; Peyton, Colonel J., 138, 141, 143; Powell, Mr., 235, 236; Powerscourt, Lord, 236; Rimington-Wilson, Mr., 12, 37; Rendlesham, Lord, 126; Ripon, Lord, 12, 37; Rous, Lord, 121; Roxburghe, Duke of, 19, 143; Rutland, Duke of, 12; Sermoneta, Duke of, 237-239; Tankerville, Lord, 126; Thornhill, Sir T., 234; Upcher, Mr., 126; Vincent, Mr., 307; Wales, Prince of, 54, 126, 235; Walsingham, Lord, 143, 234; Westminster, Duke of, 105; Wilbraham, Mr. L., 237; Wood, Mr. H., 126

Stalkers, duties of, 83

Stalking on the island of Harris and Lewis, 128

Stanford Mere, 234

Stetter's Western duck, 190

Stilt, black-winged, 209; *see* Waders

Stint, 214; *see* Waders

Strongylus pergracilis, 5

SWI

Studley Royal, sport at, 37

Suffolk, sport in, 126, 186, 206

Surface-feeding ducks, varieties of, 169; habits, 170; sheldrake, 170; plumage, 170; nesting, 171; eggs, 171; the ruddy sheldrake, 171; not regarded as a true duck, 172; wild duck, 172; the mallard, 172; 'fresh from the coast,' 173; tame wild duck, 174; widgeon, 170, 174, 182; breeding and feeding places, 175, 178; numbers, 176, 177; best time for a shot at widgeon, 176; shooting by moonlight, 177; flesh, 178; American widgeon, 178; pintail, 179; gadwall, 179; shoveller, 180; teal, 181; stalking, 181; arrival of teal, 182; form and plumage, 182; shooting, 182, 183; teal's nest, 183; garganey, 183

Swans, 153

Swivel-guns, for double punts, 243, 262, 274; breech-loaders and muzzle-loaders, 274, 275; Holland's breech-loaders, 275; theory and practice of double-barrelled breechloaders, 276, 278-281; Colonel Hawker's double gun, 278, 279; proportions of weights and charges, 281; Captain Gould's experiments, 282; Holland's $1\frac{1}{4}$ inch B.L., 283; Trulock and Harriss's $1\frac{1}{2}$ inch M.L., 284; Holland's $1\frac{1}{8}$ inch B.L., 285; ammunition box, 287; bag for cartridges, 287; breeching, 288; cartridges, 288; cases, 289; cleaning-rod for

SWI

cripple-stoppers, 289; elevating gear, 290; gun-beam, 290; gun-crutch, 290; gun-hook, 291; gun-rest, 291; ignition, 291; judging distance, 293; loading, 294; powder, 295; ramrod, 295; recoil, 296; set, 300; shot, 300; timing a shot, 302; trunnions, 302; *see* Punting and Punts
 Sykes, George, keeper, 12, 13, 35

TAINCHEL, 59

Tapeworm, 4

Taylor, the water-poet, quoted, 59

Teal, 181, 227, 228, 235, 236, 244, 258, 259, 261

Towing-rope, 302

Traps, 333

Trespassers, law concerning, 316, 317, 319, 320

Tufted duck, 188

Turnstone, 208; *see* Waders

VASELINE, 290

Vermin, 325, 329, 334

WADERS, 202; green plover, alias peewit or lapwing, 202; flight, 203; eggs, 203; netting, 203, 204; golden or whistling plover, 205; cry, 205; for the table, 205; grey plover, 205; Norfolk plover, 206; dotterel, 206; ringed plover, 206; little ringed plover, 207; Kentish plover, 207; oyster-catcher, 208; turnstone, 208; avocet, 209;

WID

black-winged stilt, 209; green-shank, 209; spotted or dusky redshank, 209; common redshank, 209; yellowshank, 210; solitary sandpiper, 210; green sandpiper, 210; wood sandpiper, 211; ruff, 211; Bartram's sandpiper, 211; buff-breasted sandpiper, 211; common sandpiper, 211; spotted sandpiper, 212; knot, 212; pectoral sandpiper, 212; curlew sandpiper, 212; purple sandpiper, 213; dunlin, 213; broad-billed sandpiper, 213; Bonaparte's sandpiper, 213; little stint, 214; Temminck's stint, 214; American stint, 214; sanderling, 214; phalaropes, 214; red-necked phalarope, 215; grey phalarope, 215; curlew, 215; whimbrel, 216; bar-tailed godwit, 216; black-tailed godwit, 216; glossy ibis, 216; spoonbill, 216; common heron, 217; purple heron, 217; night heron, 217; squacco heron, 217; common bittern, 217; American bittern, 218; little bittern, 218
 Water-hens, habits of, 221
 Waterproofs, 251
 Water-rail, 219
 Wemmergill, sport at, 37
 Whew, 175
 Whimbrel, 216; *see* Waders
 White-fronted goose, 167
 Whoopers, 156, 258; *see* Wild-fowl
 Widgeon, 151, 170, 226, 227, 235, 236, 244, 249, 257-261, 331; *see* Surface-feeding ducks and Wildfowl

WIL

Wild Birds Protection Act, 327-331
 Wild ducks, 268-272; *see* Diving ducks
 Wildfowl, and wildfowl shooting, 150; in frosty weather, 151; widgeon, 151; qualities of a successful shooter, 152; habits and haunts, 152; fowling afloat, 152, 153; swans, 153; their flight, 154, 155; feeding grounds, 155; plumage and size of the whooper, 156; Bewick's swan, 156; the mute swan, 157; the Polish swan, 157; wild geese—the brent, 157; its plumage, 157, 158; habits, 158; food, 158; trying for brent, 158; numbers killed on the Scottish coasts, 160; breeding and feeding places, 161; how to approach, 162; for the table, 162; the bernacle goose, 160; markings, 162; habits, 162; difference between bernacle and brent, 162; bean or grey goose, 163; markings of bean, 163; derivation of name, 163; abundance in Scotland, 164; habits and approach, 164, 165; influence of foggy weather on, 164; grass-cutting and feeding, 165; taking overhead, 165; flight, 165; greylag goose, 166; ancestor of the domestic species, 166, 167; white-fronted goose, 167; feeding and association with the bean, 167; habits, 167; pink-footed goose, 168; other geese, 168; celebrated estuaries, 303; depreciation of the steam launch, 305;

WOO

shooting in Scotland, 303; in England, 304-306; in Ireland, 306, 307; *see* Punting
 Wild geese, 157, 236, 261, 262; *see* Wildfowl
 Wolves, 58
 Woodcock, 112; choice of covert, 113; arrival of migrants, 114; favourite counties for nesting, 114; unsuited for long flights, 115; effect of direction and strength of winds on, 115, 116; night travelling, 116, 121, 122; direction of flight, 117; overshooting the mark, 117; countries furnishing migrants, 117; return home, 117; habits, 117; carrying the young, 118; eggs and nests, 118; extent of nesting haunts in Northern Europe, 119; feeding, 119-122; size and weight, 120; 'double woodcock,' 120; plumage, 121, 122; the late Earl of Clermont and his wager, 122; record of sport in Ireland, 123, 124; at Ashford, 123; Mr. Lloyd on cock shooting, 124; a phenomenal kill on the west coast of Ireland, 125; best coverts in England, 125, 126; in Scotland, 126; record of shooting on the island of Harris and Lewis, 126, 127; on Spurn Point, Yorkshire, 128; difficult to hit, 128, 129; how to kill, 129; clinging to shelter, 130; placing markers, 130; favourite spots, 131, 133; use of spaniels, 131; guns, 132; shot, 133; different

WOO

charges for the barrels, 133; legislation concerning, 322
 Wood pigeons, 3; *see* vol. i.
 Works quoted—Blaine's 'Rural Sports,' 313; Carnegie's 'Practical Game Preserving,' 6; Cobbold, Dr. T. Spencer, 'On the Grouse Disease,' 5; Craven's 'Recreations in Shooting,' 7; Daniel's 'Rural Sports,' 122, 308, 314; Dougall's 'Shooting Simplified,' 315; Folkard's 'Wildfowler,' 309; Gallwey's, Sir R. Payne, 'Book of Duck Decoys,' 175; ditto, 'Fowler in Ireland,' 125, 138, 153, 204; Gordon's 'Earldom of Sutherland,' 58; Greener's 'Gun and its Development,' 36, 312; Gurney and Fisher's 'Account of the Birds found in Norfolk,' 142; Hawker, Colonel, 308; Johnson's 'Sportsman's Cyclo-pedia,' 314; Lacy's 'Modern Shooter,' 310; Leveson's 'Sport in Many Lands,' 314; Malcolm's 'The Population, Crofts, Sheep-walks, and

YOR

Deer Forests of Highlands and Islands,' 111; 'Marksman's' 'Dead Shot,' 311; Maxwell's 'Field Book of Sports and Pastimes,' 314; Mills' 'Sportsman's Library,' 314; 'Modern Wildfowling,' 312; 'Morning Post,' 37; North's 'Rambles after Sport,' 314; 'Oakleigh Shooting Code,' 7; Speedy's 'Sport in the Highlands and Lowlands of Scotland,' 7, 23; 'Sporting Magazine,' 142, 315; 'Sporting Review,' 124; Thompson's 'Natural History of Ireland,' 314; Thornhill's 'Shooting Directory,' 7; Walsh's 'Modern Sportsman's Gun and Rifle,' 313; 'Zoologist,' 142

YARMOUTH, 304

Yarrell, quoted, 120, 164
 Yellowshank, 210; *see* Waders
 Yorkshire, sport in, 2, 35, 36, 128, 168, 175, 192